



2021

CATALOGUE

| Spark Plugs | Glow Plugs



Android Only

Spark Plugs | Glow Plugs

CATALOGUE



2021



Car • SUV • LCV	_____	page	1
Commercial Vehicles	_____	page	65
Motor Cycles	_____	page	69
• ATV	_____	page	73
• Golf Cart	_____	page	74
• Motorcycles	_____	page	102
• Scooters	_____	page	105
Marine	_____	page	107
• Inboard	_____	page	109
• Jet Ski	_____	page	126
• Outboard	_____	page	129
Garden Equipment	_____	page	130
• Blower	_____	page	138
• Brush Cutters	_____	page	142
• Chainsaw	_____	page	143
• Lawn Mowers	_____	page	145
• Power Pruner	_____	page	146
• Ride-On Mowers	_____	page	147
Commercial & Industrial Engines	_____	page	148
• Construction Engine	_____	page	151
• Farm Equipment	_____	page	152
• Gasoline Engines	_____	page	153
• General Purpose	_____	page	158
• Generator	_____	page	159
• Industrial Equipment	_____	page	160
• Lawn Mower Engines	_____	page	161
• Multi-purpose Engines	_____	page	169
• Pumps	_____	page	198
Go Kart	_____	page	200
Glow Plugs Conversion Chart	_____	page	201
Spark Plug Conversion Chart	_____	page	203
Discontinued and Replacement Plugs	_____	page	204
Discontinued Plugs and Glow Plugs	_____	page	205
NGK Glow Plug Types and Features	_____	page	206
Temperature Characteristics	_____	page	229
Testing of NGK Glow Plug	_____	page	230
New Series of Glow Plugs	_____	page	231
Series of NGK Glow Plugs	_____	page	232
Structure of a Glow Plug	_____	page	233
Design Symbols used in NGK Glow Plugs	_____	page	237
Glow Plug Trouble Tracing	_____	page	248
Glow Plug Fault Finding	_____	page	249
NGK Spark Plug Resistor Covers	_____	page	251
Series of NGK Spark Plugs	_____	page	252
Structure of a NGK Spark Plug	_____	page	253
NGK Spark Plug Information chart	_____	page	
Various Spark Plugs and their Characteristics	_____	page	
Anti-Fouling Characteristics	_____	page	
NGK Spark Plug Diagnostic Chart	_____	page	





CAR • SUV • LCV



Model	Type	Capacity	Year	Cyl	Engine	Gap	Recommended	Stock Code	Alternative	Stock Code
ABARTH										
124 SPIDER	1.4 T	1400	2016->	4	55253268	0,8	IKR9J8	93311		ABARTH
124 SPIDER	1.4 T SPIDER	1400	2016->	4	312A1000	0,8	IKR9J8	93311		
500	1.4 TURBO	1400	2008->	4	312A1000	0,8	IKR9J8	93311		
500	1.4 TURBO	1400	2010->	4	312A3000	0,8	IKR9J8	93311		
500	1.4 TURBO	1400	2010->	4	312A3000	0,8	IKR9J8	93311		
500	1.4 TURBO	1400	2011->	4	312A1000	0,8	IKR9J8	93311		
500C	1.4 T	1400	2009->	4	312A3000	0,8	IKR9J8	93311		
500C	1.4 T	1400	2010->	4	312A3000	0,8	IKR9J8	93311		
500C	1.4 T	1400	2013->	4	312A3000	0,9	IKR9J8	93311		
500C	1.4 T	1400	2016->	4	312B3000	0,8	IKR9J8	93311		
695	695 TRIBUTO FERRARI	1400	2012->	4	312A1000	0,8	IKR9J8	93311		
PUNTO	1.4 16V EVO	1400	2011->	4	199A8.000	0,8	IKR9J8	93311		

ALFA ROMEO										
145	2.0 16V T-SPARK	2000	1995->2000	4	AR67204	0,7,0,9	BKR6EKP+PMR7A	2513+4259		
146	2.0 16V T-SPARK	2000	1996->1999	4	AR67204	0,7,0,9	BKR6EKP+PMR7A	2513+4259		
147	1.6 16V T-SPARK	1600	2001->	4	AR32104	0,7,0,9	BKR6EKP+PMR7A	2513+4259		
147	1.9 JTD	1900	2004->	4	AR37.101		Y-534J	5540		
147	1.9 JTD	1900	2004->2005	4	937A.2000		Y-534J	5540		
147	1.9 JTDM	1900	2004->2007	4	939A.7000		Y-1030J	90002		
147	2.0 16V T-SPARK	2000	2000->	4	AR32310	0,7,0,9	BKR6EKP+PMR7A	2513+4259		
147	3.2 GTA	3200	2004->2006	6	932A.000	0,8	PFR6B	3500	BKR6E	97737
155	2.0 I T-SPARK	2000	1992->1995	4	AR67202	0,8	BCPR6ES	96990	BCP6ES	94000
155	2.0 T-SPARK	2000	1995->1998	4	AR67202	0,7,0,9	BKR6EKP+PMR7A	2513+4259		
155	2.5 V6	2500	1996->1998	6	AR67301	0,8	BPR7ES	95164		
156	1.9 JTD	1900	2004->	4	AR32302		Y-534J	5540		
156	2.0 16V T-SPARK	2000	1998->2000	4	AR32301	0,7,0,9	BKR6EKP+PMR7A	2513+4259		
156	2.4 JTD	2400	2003->	5	AR32501		Y-534J	5540		
156	2.5 V6 24V	2500	2000->2006	6	AR32401	0,8	PFR6B	3500	BKR6E	97737
156	3.2 GTA SPORTWAGON	3200	2003->2006	6	932A.000	0,8	PFR6B	3500	BKR6E	97737
159	1750 TBI	1800	2009->2011	4	939B.1000	0,6	ILKAR7D-6G	93607		
159	1.8 TBI	1800	2009->2011	4	939B.1000	0,8	ILKAR7D-6G	93607		
159	1.9 JTDM	1900	2006->2011	4	939A.1000		Y-534J	5540		
159	1.9 JTS 16V	1900	2006->2011	4	939A.6000	0,8	FR5CP	6368	BKR5E	92870
159	2.0 JTDM	2000	2009->2011	4	844A.2000		Y-9003AS	95836		
159	2.0 JTDM	2000	2009->2011	4	939B.3000		Y-9003AS	95836		
159	2.0 JTDM	2000	2010->2011	4	939B.4000		Y-9003AS	95836		
159	2.2 JTS 16V	2200	2006->2011	4	939A.5000	0,8	FR5CP	6368	BKR5E	92870
159	2.4 JTDM	2400	2005->2007	5	939A.3000		YE07	6092		
159	3.2 JTS 24V	3200	2006->2013	6	939A.000	1,3	PTR5A-13	2467	TR5B-13	97667
164	2.0 T-SPARK	2000	1987->1992	4	AR06416	0,8	BCPR6ET	2197		
164	3.0 12V V6	3000	1993->1999	6	AR66301	0,8	PFR6B	3500	BKR6E	97737
164	3.0 QUADRIFOGLIO V6	3000	1993->1998	6	AR64304	0,8	BCPR6ET	2197		
166	2.0 16V T-SPARK	2000	1998->2006	4	AR34103	0,7,0,9	BKR6EKP+PMR7A	2513+4259		
166	3.0 V6 24V SPORTRONIC	3000	1999->2006	6	AR34301	0,8	PFR6B	3500	BKR6E	97737
166	3.2 TI PROGRESSION	3200	2004->2007	6	932A.000	0,8	PFR6B	3500	BKR6E	97737
33	1.5 WAGON	1500	1984->1993	4	AR30734/51	0,8	BPR7ES	95164		
33	1.7 16V SPORT WAGON	1700	1993->1994	4	AR30746	0,8	BCPR6ET	2197		
4C	1.8 TBI	1800	2013->	4	960A.1000	0,6	ILKAR7D-6G	93607		
ALFASUD	1.3 TI	1300	1980-1984->	4	AR30168	0,8	BP6ES	91076	BPR6ES	96989
ALFASUD	1.5 TI SPRINT	1500	1978->1982	4	AR30128	0,8	BP6ES	91076	BPR6ES	96989
ALFETTA	1.8 GTV	1800	1973->1980	4	AR01678	0,8	B7ES	1111	BR7ES	5122
ALFETTA	2.0 GTV	2000	1976->1985	4	AR01655	0,8	B7ES	1111	BR7ES	5122
ALFETTA	2.0 GTV	2000	1972->1985	4	AR01713	0,8	B7ES	1111	BR7ES	5122
BRERA	1.8 TBI	1800	2009->2011	4	939B.1000	0,6	ILKAR7D-6G	93607		
BRERA	2.2 JTS	2200	2006->2011	4	939A.5000	0,8	FR5CP	6368	BKR5E	92870
BRERA	3.2 JTS	3200	2007->2013	6	939A.000	1,3	PTR5A-13	2467	TR5B-13	97667
EXPORT	1.5 GL	1500	1980->1985	4	301.24	0,8	B7ES	1111	BR7ES	5122
EXPORT	1.5 VELOCE	1500	1980->1985	4	301.24	0,8	B7ES	1111	BR7ES	5122
GIULIA	2.0 T	2000	2016->	4	55273835	0,7	ILZKR7G7G	90219		
GIULIA	2.9 I QUADRIFOGLIO	2900	2015->	6	670050436	0,7	LKAR8AP7JDS	96748		
GIULIA	3.0 T	3000	2015->	6	670050436	0,8	LKAR8AP7JDS	96748		
GIULIETTA	1750 QUADRIFOGLIO	1800	2010->	4	940A.1000	0,6	ILKAR7D-6G	93607		
GIULIETTA	1.4 T MULTI AIR	1400	2010->	4	940A.2000	0,8	IKR9J8	93311		
GIULIETTA	1.4 TURBO	1400	2010->	4	198A.4000	0,8	IKR9J8	93311		
GIULIETTA	1.8 TURBO	1800	1979->1985	4	AR01678	0,8	B7ES	1111	BR7ES	5122
GIULIETTA	2.0 TI	2000	1982->1985	4	AR01699	0,8	B7ES	1111	BR7ES	5122
GT	1.9 JTD	1900	2004->	4	937A.2000		Y-534J	5540		
GT	1.9 RDM 16V	1900	2003->	4	937A.5000		YE07	6092		
GT	3.2 V6 24V	3200	2003->2004	6	936A.6000	0,8	PFR6B	3500	BKR6E	97737
GTV	2.0 TS 16V	2000	1996->1999	4	AR16201	0,7,0,9	BKR6EKP+PMR7A	2513+4259		



CAR • SUV • LCV



ALFA ROMEO

Model	Type	Capacity	Year	Cyl	Engine	Gap	Recommended	Stock Code	Alternative	Stock Code
ALFA ROMEO										
GTV	3.0 V6 24 V	3000	1997->2001	6	AR16102	0,8	PFR6B	3500	BKR6E	97737
GTV	3.2 V6 24V	3200	2004->	6	936A.6000	0,8	PFR6B	3500	BKR6E	97737
GTV 6	2.5 GTV	2500	1982->1985	6	AR01646	0,8	B7ES	1111	BR7ES	5122
GTV 6	3.0 GTV	3000	1983->1985	6		0,8	B7ES	1111	BR7ES	5122
MITO	0.9 T	900	2011->	2	312A.2000	0,8	ILKR9G8	97168		
MITO	0.9 T	900	2013->	2	199B.6000	0,8	ILKR9G8	97168		
MITO	1.4 I	1400	2008->	4	955A.1000	1	ZKR7A-10	1691		
MITO	1.4 TB	1400	2009->	4	940A.2000	0,8	IKR9J8	93311		
MITO	1.4 TB	1400	2009->	4	955A.2000	0,8	IKR9J8	93311		
MITO	1.4 TBI	1400	2009->	4	955A.2000	0,8	IKR9J8	93311		
MITO	1.4 TURBO	1400	2008->	4	199A.8000	0,8	IKR9J8	93311		
PANEL VAN	1.5 LCV	1500	1989->1992	4		0,8	BPR7ES	95164		
SPIDER	1.8 TBI	1800	2009->	4	939B.1000	0,6	ILKAR7D-6G	93607		
SPIDER	2.0 16V T-SPARK	2000	1996->1999	4	AR16201	0,7,0,9	BKR6EKPA+PMR7A	2513+4259		
SPIDER	2.0 FI,QUADRIFOGLIO	2000	1971->1989	4	AR00515	0,8	B7ES	1111	BR7ES	5122
SPIDER	2.0 JTS 16V	2000	2004->	4	937A.1000	0,9	BKR6EKPA	2513	BKR6EK	94007
SPIDER	2.2 JTS	2200	2006->	4	939A.5000	0,8	FR5CP	6368	BKR5E	92870
SPIDER	3.0 V6 24V	3000	1998->2004	6	AR16102	0,8	PFR6B	3500	BKR6E	97737
SPIDER	3.2 JTS	3200	2004->	6	936A.6000	0,8	PFR6B	3500	BKR6E	97737
SPRINT	1.3 L	1300	1990->	4	AR301.68	0,8	BP6ES	91076	BPR6ES	96989
SPRINT	1.5 VELOCE	1500	1980->1985	4	AR301.28	0,8	B7ES	1111	BR7ES	5122
STELVIO	949 2.0L Q4	2000	2017->	4	552 73 835	0,7	ILZKR7G7G	90219		

ASIA										
ROCSTA	1.8 4X4	1800	1994->1997	4	F8	0,8	BPR5ES	94084		
ROCSTA	2.2 4X4	2200	1994->1997	4	R2		Y-107-1	6625		

ASTON MARTIN										
DB9	6.0 COUPE	6000	2003->	12	V12	1,3	PTR6D-13	5598	BPR6EFS-15	4871
DB9	6.0 VOLANTE	6000	2004->	12	V12	1,3	PTR6D-13	5598	BPR6EFS-15	4871
VANQUISH	5.9 I	5900	2005->	8	AM702	1,3	PTR6D-13	5598	BPR6EFS-15	4871
VANTAGE	5.3 I	5300	1993->	8		0,8	BCR8ES	5430		
VIRAGE	5.3 V8 32V	5300	1990->1998	8		0,8	BCPR6E	96245		

AUDI										
100	1.6 LS	1600	1977->1984	4	YV	0,8	BPR6ESZ-N	91711	BPR6ES	96989
100	1.8 L	1800	1970->1976	4	ZZ	0,8	BP6ES	91076	BPR6ES	96989
100	1.9 CARB.	1900	1982->1983	5	WB,WH	0,8	BPR6ESZ-N	91711	BPR6ES	96989
100	2.0 TD	2000	1982->1990	4			Y-918J	3704		
100	2.2 GLS 5E F. INJ.	2200	1984->1986	5	WC	0,8	BPR6ESZ-N	91711	BPR6ES	96989
100	2.5 TDI	2500	1991->1992	5	ABP		Y-732J	5909		
200	2.2 GLX 5E F. INJ.	2200	1978->1983	5	WC	0,8	BPR6ESZ-N	91711	BPR6ES	96989
400	1.8 CARB.	1800	1987->1991	4	JW	0,8	BPR7ESZ-N	92591	BPR7ES	95164
500	2.2 E,SE F. INJ.	2200	1977->1984	5	WC,PR	0,8	BPR7ESZ-N	92591	BPR7ES	95164
500	2.2 TURBO	2200	1989->1992	5	AAN	1	BKUR6ET-10	90599		
500	2.3 E,SE	2300	1991->1995	5	AAR	0,8	BPR6ESZ-N	91711	BPR6ES	96989
500	2.3 TURBO	2300	1990->1995	5	MC	0,8	BP6ET	90921	BP6ES	91076
500	2.6 AVANT	2600	1994->1995	5	ABC	1	BKUR6ET-10	90599		
500	2.8 SE,SEL	2800	1994->1996	6	AAH	1	BKUR6ET-10	90599		
80	1.5	1500	1972->1974	4	ZB	0,8	BP6ES	91076	BPR6ES	96989
80	1.6 GL,GLS	1600	1976->1981	4	ZF,YP,WY	0,8	BPR6ESZ-N	91711	BPR6ES	96989
90 SUPER	1.8 GL	1800	1966->1972	4	ZZ	0,8	B8ES	2411	BR8ES	5422
A1	1.0 TFSI	1000	2015->	3	CHZB	0,8	PKER7A8EGS	95463		
A1	1.0 TFSI S	1000	2015->	3	CHZC	0,8	PKER7A8EGS	95463		
A1	1.2 TFSI	1200	2010->	4	CBZA	0,7	IZFR6P-7	97153		
A1	1.4 TFSI	1395	2014->2018	4	DADA		PZKER7A8EGS	94968		
A1	1.4 TFSI	1400	2010->	4	CAXA	0,8	PZFR6R	5758	ZFR6F-11	93208
A1	1.4 TFSI	1400	2015->	4	CZCA	0,8	PZKER7B8EGS			
A1	1.4 TFSI S-LINE	1400	2010->	4	CAVG	0,8	SIZFR6B8EG	96209		
A1	1.4 TSI	1400	2012->	4	CXS	0,8	PZKER7B8EGS			
A1	1.6 TDI	1600	2010->	4	CAYB		Y-1002AS	8926		
A1	1.6 TDI	1600	2010->	4	CAYC		Y-1002AS	8926		
A1	2.0 TDI	2000	2011->	4	CFHD		Y-1002AS	8926		
A1	2.0 TDI	2000	2012->	4	CFHB		Y-1002AS	8926		
A1	2.0 TFSI	2000	2012->	4	CDLH	0,8	PFR7S8EG	1675		
A3	1.0 TFSI	1000	2015->	3	CHZC	0,8	PKER7A8EGS	95463		
A3	1.2 TFSI	1200	2014->	4	CVVB	0,8	PZKER7B8EGS			
A3	1.2 TFSI SPORTBACK	1200	2010->2012	4	CBZB	0,7	IZFR6P-7	97153		
A3	1.2 TS	1200	2014->	4	CVVB	0,8	PZKER7B8EGS			



CAR • SUV • LCV



Model	Type	Capacity	Year	Cyl	Engine	Gap	Recommended	Stock Code	Alternative	Stock Code
AUDI										
A3	1.2 TSI	1200	2012->	4	CJZA	0,8	PZKER7B8EGS			
A3	1.4 TFSI	1400	2007->2008	4	CAXC	0,8	PZFR6R8EG	96498		
A3	1.4 TFSI	1400	2010->2012	4	CM5A	0,8	PZFR6R8EG	96498		
A3	1.4 TFSI	1400	2013->	4	CPWA	0,8	PZKER7B8EGS			
A3	1.4 TFSI	1400	2013->	4	CXSB	0,8	PZKER7B8EGS			
A3	1.4 TFSI	1400	2013->	4	CZCA	0,8	PZKER7B8EGS			
A3	1.4 TFSI SPORTBACK	1400	2018->	4	DADA	0,8	PZKER7B8EGS			
A3	1.4 TSI	1400	2012->	4	CXSA	0,8	PZKER7B8EGS			
A3	1.6 I	1600	2002->2003	4	BFQ	1	BKUR6ET-10	90599		
A3	1.6 I	1600	2008->2010	4	CCSA	1	BKUR6ET-10	90599		
A3	1.6 TDI	1600	2009->2012	4	CAYB		Y-1002AS	8926		
A3	1.6 TDI	1600	2009->2012	4	CAYC		Y-1002AS	8926		
A3	1.6 TDI	1600	2012->	4	CLHA		Y-1002AS	8926		
A3	1.6 TDI	1600	2013->	4	CRKB		Y-1002AS	8926		
A3	1.6 TFSI	1600	2010->2012	4	CMXA	1	BKUR6ET-10	90599		
A3	1.8 20V DOHC	1800	1996->1997	4	AGN	1	BKUR6ET-10	90599		
A3	1.8 I	1800	1996->2003	4	AUM	0,8	PFR6Q	6458	BKR6E	97737
A3	1.8 TFSI	1800	2007->2007	4	BYT	0,8	PFR7S8EG	1675		
A3	1.8 TFSI	1800	2007->2008	4	BZB	0,8	PFR7S8EG	1675		
A3	1.8 TFSI	1800	2008->2012	4	CDAA	0,8	PFR7S8EG	1675		
A3	1.8 TFSI	1800	2013->	4	CJSA	0,8	PLFER7A8EG	94833		
A3	1.8 TFSI	1800	2013->	4	CJSB	0,8	PLFER7A8EG	94833		
A3	1.8 TURBO	1800	1997->2003	4	AGU	1	BKUR6ET-10	90599		
A3	1.9 TDI	1900	2005->2007	4	BLS		Y-607AS	9776		
A3	2.0 A3 , S3	2000	2008->2012	4	CDLC	0,8	PFR7S8EG	1675		
A3	2.0 FSI	2000	2004->2005	4	BLY	0,8	BKR6E	97737		
A3	2.0 FSI	2000	2004->2005	4	BMB	0,8	BKR6E	97737		
A3	2.0 FSI	2000	2004->2005	4	WAU, BVY	1,1	PZFR5N-11T	7742		
A3	2.0 FSI	2000	2004->2008	4	AXW	1,1	PZFR5N-11T	7742		
A3	2.0 FSI	2000	2005->2008	4	BVZ	0,8	BKR6E	97737		
A3	2.0 I	2000	2010->2012	4	CBFA	0,8	PFR7S8EG	1675		
A3	2.0 T FSI	2000	2005->2008	4	AXX	0,8	PFR7S8EG	1675		
A3	2.0 TDI	2000	2003->2007	4	BKD		YE14	5661		
A3	2.0 TDI	2000	2005->2007	4	BMM		CZ104	9810		
A3	2.0 TDI	2000	2006->2012	4	BUY, BMN		CZ304	9835		
A3	2.0 TDI	2000	2006->2012	4	CBAA, CBBB		Y-609AS	6074		
A3	2.0 TDI	2000	2006->2012	4	CFGB		Y-1002AS	8926		
A3	2.0 TDI	2000	2010->2012	4	CLJA		Y-1002AS	8926		
A3	2.0 TDI	2000	2012->	4	CRBC		Y-1002AS	8926		
A3	2.0 TDI	2000	2012->	4	CRFC		Y-1002AS	8926		
A3	2.0 TDI	2000	2012->	4	CRLB		Y-1002AS	8926		
A3	2.0 TDI	2000	2012->	4	CUPA		Y-1002AS	8926		
A3	2.0 TDI	2000	2013->	4	CRBD		Y-1002AS	8926		
A3	2.0 TDI	2000	2013->	4	CRFA		Y-1002AS	8926		
A3	2.0 TFSI	2000	2005->2012	4	BWA	0,8	PFR7S8EG	1675		
A3	2.0 TFSI SPORTBACK	2000	2018->	4	CJSA, CJSB	0,8	PLFER7A8EG	94833		
A3	2.0 TFSI	2000	2016->	4	CZPB		PLFER7A8EG	94833		
A3	3.2 I	3200	2004->2008	6	BDB, BMJ, BUB	0,8	IZKR7B	7563	ZKR7A-10	1691
A3	3.2 QUATTRO	3200	2007->2008	6	BUB	0,8	IZKR7B	7563	ZKR7A-10	1691
A3	RS3 2.5 TFSI QUATT	2480	2015->	5	CZGB	0,7	SILFER8C7ES			
A4	1.4 TFSI	1400	2008->	4	CDH	0,8	PFR7S8EG	1675		
A4	1.6 I	1600	2000->2008	4	ALZ	1	BKUR6ET-10	90599		
A4	1.8 E 20V ESTATE, TURBO	1800	1995->2001	4	ADR, AGU, AEB	0,8	BKUR6ET-10	90599		
A4	1.8 I	1800	1999->2001	4	APT	1	BKUR6ET-10	90599		
A4	1.8 I	1800	2002->2004	4	BEX	0,8	PFR6Q	6458	BKR6E	97737
A4	1.8 T	1800	2002->2006	4	BFB	0,8	PFR6Q	6458	BKR6E	97737
A4	1.8 TFSI	1800	2007->2009	4	CABB	0,8	PFR7S8EG	1675		
A4	1.8 TFSI	1800	2008->	4	CDHA	0,8	PFR7S8EG	1675		
A4	1.8 TFSI	1800	2008->	4	CDHB	0,8	PFR7S8EG	1675		
A4	1.8 TFSI	1800	2008->2008	4	CABA	0,8	PFR7S8EG	1675		
A4	1.8 TS	1800	2011->	4	CJEB	0,8	PLFER7A8EG	94833		
A4	1.8 TURBO	1800	1996->1998	4	AEB	0,8	PFR6Q	6458	BKR6E	97737
A4	1.8 TURBO	1800	1998->2001	4	APU	0,8	PFR6Q	6458	BKR6E	97737
A4	1.8 TURBO	1800	2000->2002	4	AVJ	0,8	PFR6Q	6458	BKR6E	97737
A4	1.8 TURBO	1800	2001->2004	4	AOC	0,8	PFR6Q	6458	BKR6E	97737
A4	1.8 TURBO	1800	2002->2004	4	BFB	0,8	PFR6Q	6458	BKR6E	97737
A4	1.9 TDI	1900	2000->2003	4	AWX		Y-741U	5065		
A4	1.9 TDI	1900	2000->2004	4	AVF		Y-741U	5065		
A4	2.0 EXEC	2000	2000->2004	4	ALT	1	BKUR5ETC-10	90531		
A4	2.0 EXEC	2000	2001->2005	4	ALT	1	BKUR5ETC-10	90531		
A4	2.0 T FSI	2000	2005->2008	4	BUL, BWE, BGB	0,8	PFR7S8EG	1675		
A4	2.0 TDI	2000	2004->2005	4	BLB		YE14	5661		

AUDI



CAR • SUV • LCV



Model	Type	Capacity	Year	Cyl	Engine	Gap	Recommended	Stock Code	Alternative	Stock Code
AUDI										
A4	2.0 TDI	2000	2005->	4	BRE		CZ304	9835		
A4	2.0 TDI	2000	2005->2008	4	BPW		CZ104	9810		
A4	2.0 TDI	2000	2006->2008	4	BRF,BVG,BVA,BRD		CZ304	9835		
A4	2.0 TDI	2000	2007->	4	CAGA		Y-609AS	6074		
A4	2.0 TDI	2000	2008->	4	CAGC,CAHB		Y-609AS	6074		
A4	2.0 TDI	2000	2008->	4	CAHA		Y-609AS	6074		
A4	2.0 TDI	2000	2010->	4	CJCB,CMEA		Y-1002AS	8926		
A4	2.0 TDI	2000	2013->	4	CGLC		Y-1002AS	8926		
A4	2.0 TDI	2000	2013->	4	CJCD		Y-1002AS	8926		
A4	2.0 TDI	2000	2013->	4	CMFB		Y-1002AS	8926		
A4	2.0 TDI	2000	2013->	4	CNHA		Y-1002AS	8926		
A4	2.0 TDI E S	2000	2010->	4	CMEA		Y-1002AS	8926		
A4	2.0 TFSI	2000	2004->2005	4	BGB	0,8	PFR6Q	6458	BKR6E	97737
A4	2.0 TFSI	2000	2008->	4	CDNB	0,8	PFR7S8EG	1675		
A4	2.0 TFSI	2000	2009->	4	CDNC	0,8	PFR7S8EG	1675		
A4	2.0 TFSI	2000	2013->	4	CDNC	0,8	PLFER7A8EG	94833		
A4	2.0 TFSI	2000	2013->	4	CNCD	0,8	PLFER7A8EG	94833		
A4	2.0 TFSI	2000	2015->	4	CYRB,CYMC		PLFER7A8EG	94833		
A4	2.4 I	2400	2001->2004	6	APS	0,8	BKR6EKUB	3584		
A4	2.4 V6 AVANT	2400	1998->2001	6	AGA,AMM,BDV	0,8	BKR6EKUB	3584		
A4	2.5 TDI	2500	2000->2003	6	AKE		Y-501U	3786		
A4	2.5 TDI	2500	2002->2003	6	AFB		Y-501U	3786		
A4	2.6 AVANT	2600	1996->1998	6	ABC	1	BKUR6ET-10	90599		
A4	2.7 TDI	2700	2006->2009	6	BPP		Y-609AS	6074		
A4	2.8 V6 30V AVANT	2800	1997->2001	6	ACK	0,8	BKR6EKUB	3584		
A4	2.8 I	2800	1999->2001	6	ATX		BKR6EKUB	3584		
A4	2.8 SPORT AVANT, QUATTRO, TIPTRONIC	2800	1995->2001	6	AAH	1	BKUR6ET-10	90599		
A4	3.0 QUATTRO	3000	2001->2005	6	ASN	0,8	BKR6EKUB	3584		
A4	3.0 T QUATTRO	3000	2011->	6	CMUA	0,8	PFR8S8EG	94460		
A4	3.0 TDI	3000	2004->2009	6	BKN		Y-609AS	6074		
A4	3.0 TDI	3000	2006->2009	6	ASB		Y-609AS	6074		
A4	3.0 TDI	3000	2007->2008	6	CAPA		Y-609AS	6074		
A4	3.0 TDI	3000	2008->	6	CCWA		Y-609AS	6074		
A4	3.0 TDI	3000	2008->2010	6	CCWB		Y-609AS	6074		
A4	3.0 TDI	3000	2011->	6	CDUC		Y-1002AS	8926		
A4	3.0 TFSI	3000	2009->	6	CCBA/CAKA	0,8	PFR8S8EG	94460		
A4	3.0 V6	3000	2001->2004	6	BBJ	0,8	BKR6EKUB	3584		
A4	3.2 FSI	3200	2005->2008	6	AUK	0,8	PFR7W-T	6840		
A4	3.2 FSI	3200	2007->	6	CALA	1,1	PFR6X-11	5757	BKR6ES-11	94437
A4	4.2 FSI	4200	2003->	8	BBK	0,8	BKR6EQUP	3199	BKR6EQUA	6872
A4	4.2 FSI	4200	2006->2008	8	BHF	0,8	BKR6EQUP	3199	BKR6EQUA	6872
A5	1.8 TFSI	1800	2011->	4	CJEB	0,8	PLFER7A8EG	94833		
A5	1.8 TFSI	1800	2014->	4	CJED	0,8	PLFER7A8EG	94833		
A5	1.8 TURBO	1800	2009->	4	CDHB	0,8	PFR7S8EG	1675		
A5	2.0 TDI	2000	2008->	4	CAHB		Y-609AS	6074		
A5	2.0 TDI	2000	2009->	4	CAGA		Y-609AS	6074		
A5	2.0 TDI	2000	2010->	4	CMEA		Y-1002AS	8926		
A5	2.0 TDI	2000	2011->	4	CGLC		Y-1002AS	8926		
A5	2.0 TDI	2000	2013->	4	CJCD		Y-1002AS	8926		
A5	2.0 TDI	2000	2013->	4	CMFB		Y-1002AS	8926		
A5	2.0 TDI	2000	2013->	4	CNHA		Y-1002AS	8926		
A5	2.0 TFSI	2000	2009->	4	CAEA/CDNC/CAEB	0,8	PFR7S8EG	1675		
A5	2.0 TFSI	2000	2013->	4	CDNC	0,8	PLFER7A8EG	94833		
A5	2.0 TFSI	2000	2013->	4	CNCD	0,8	PLFER7A8EG	94833		
A5	2.0 TURBO	2000	2008->	4	CDNC,CAEB	0,8	PFR7S8EG	1675		
A5	2.7 TDI	2700	2007->2008	6	CAMA		Y-609AS	6074		
A5	2.7 TDI	2700	2008->	6	CGKB		Y-609AS	6074		
A5	3.0 TDI	3000	2007->2008	6	CAPA		Y-609AS	6074		
A5	3.0 TDI	3000	2008->2010	6	CCWB		Y-609AS	6074		
A5	3.0 TDI	3000	2009->	6	CCWA		Y-609AS	6074		
A5	3.0 TDI	3000	2011->	6	CDUC		Y-1002AS	8926		
A5	3.0 TFSI	3000	2011->	6	CMUA	0,8	PFR8S8EG	94460		
A5	3.0 TFSI S5	3000	2012->	6	CAKA	1,1	PFR6X-11	5757	BKR6ES-11	94437
A5	3.0 TFSI S5	3000	2012->	6	CCBA	1,1	PFR6X-11	5757	BKR6ES-11	94437
A5	3.2 FSI	3200	2007->	6	CALA	1,1	PFR6X-11	5757	BKR6ES-11	94437
A6	1.8 TFSI	1800	2015->	4	CYGA	0,8	PLFER7A8EG	94833		
A6	2.0 I	2000	1994->1996	4	ACE	0,8	BCPR7ET	2164		
A6	2.0 TDI	2000	2009->	4	CAHB		Y-609AS	6074		
A6	2.0 TDI	2000	2011->	4	CGLC		Y-1002AS	8926		
A6	2.0 TDI	2000	2011->	4	CMGB		Y-1002AS	8926		
A6	2.0 TDI	2000	2012->	4	CGLE		Y-1002AS	8926		
A6	2.0 TFSI	2000	2005->	4	BPJ	0,8	PFR7S8EG	1675		



CAR • SUV • LCV



Model	Type	Capacity	Year	Cyl	Engine	Gap	Recommended	Stock Code	Alternative	Stock Code
AUDI										
A6	2.0 TFSI	2000	2011->	4	CAEB	0,8	PFR7S8EG	1675		
A6	2.0 TFSI	2000	2011->	4	CDNB	0,8	PFR7S8EG	1675		
A6	2.3 S6	2200	1996->	4	AAN	0,8	PFR7B	4853	BCPR7ES	93606
A6	2.4 V6	2400	1999->2001	6	APS	0,8	BKR6EKUB	3584		
A6	2.4 V6	2400	2001->2005	6	BDV	0,8	BKR6EKUB	3584		
A6	2.4 V6	2400	2004->	6	BDW	1,1	PFR6X-11	5757	BKR6ES-11	94437
A6	2.4 V6 TIP, MULTI-TRONIC	2400	1997->1999	6	AGA	0,8	BKR6EKUB	3584		
A6	2.5 TDI	2500	1994->1997	5	AAT		Y-732J	5909		
A6	2.5 TDI	2500	1999->2003	6	AKE		Y-501U	3786		
A6	2.5 TDI	2500	2002->2003	6	BFC		Y-501U	3786		
A6	2.5 TDI	2500	2003->2005	6	BDG		Y-501U	3786		
A6	2.5 TDI V6	2500	1997->2000	6	AFB		Y-501U	3786		
A6	2.6 V6 AVANT	2600	1994->1996	6	ABC	1	BKUR6ET	92235		
A6	2.7 BI-TURBO	2700	2000->2002	6	ARE	0,8	PFR6Q	6458	BKR6E	97737
A6	2.7 T QUATTRO, BI TURBO	2700	1999->2000	6	AJK,AZA	0,8	PFR6Q	6458	BKR6E	97737
A6	2.7 TDI	2700	2005->	6	BSG		Y-609AS	6074		
A6	2.7 TDI	2700	2008->	6	CANA		Y-609AS	6074		
A6	2.7 TDI	2700	2008->	6	CANC		Y-609AS	6074		
A6	2.8 EXEC	2800	1995->1998	6	AAH	1	BKUR6ET-10	90599		
A6	2.8 FSI	2800	2006->	6	BDX	1,1	PFR6X-11	5757	BKR6ES-11	94437
A6	2.8 FSI	2800	2008->	6	CCEA	1,1	PFR6X-11	5757	BKR6ES-11	94437
A6	2.8 V6 30V	2800	1995->1998	6	ACK	0,8	BKR6EKUB	3584		
A6	3.0 QUATTRO	3000	2001->2006	6	BBJ	0,8	BKR6EKUB	3584		
A6	3.0 QUATTRO, TIP, MULTI-TRONIC	3000	2001->2005	6	ASN	0,8	BKR6EKUB	3584		
A6	3.0 TDI	3000	2004->2006	6	BMK		Y-609AS	6074		
A6	3.0 TDI	3000	2006->	6	ASB		Y-609AS	6074		
A6	3.0 TDI	3000	2008->	6	CDYA		Y-609AS	6074		
A6	3.0 TDI	3000	2008->	6	CDYC		Y-609AS	6074		
A6	3.0 TDI	3000	2011->	6	CLAA		Y-1002AS	8926		
A6	3.0 TDI	3000	2011->	6	CLAB		Y-1002AS	8926		
A6	3.0 TDI MULTI	3000	2011->	6	CDUC		Y-1002AS	8926		
A6	3.0 TFSI	3000	2008->	6	CAJ	0,8	PFR8S8EG	94460		
A6	3.0 TFSI	3000	2011->	6	CGWB	0,8	PFR8S8EG	94460		
A6	3.0 TFSI	3000	2011->	6	CGXB	0,8	PFR8S8EG	94460		
A6	3.2 V6	3200	2004->	6	AUK	0,8	PFR7W-T	6840		
A6	3.2 V6	3200	2008->	6	BKH	1,1	PFR6X-11	5757	BKR6ES-11	94437
A6	3.2 V6	3200	2009->	6	CALA	1,1	PFR6X-11	5757	BKR6ES-11	94437
A6	4.2 FSI	4200	1999->2001	8	ARS	0,8	BKR6EQUP	3199	BKR6EQUA	6872
A6	4.2 FSI	4200	2000->2005	8	ANK	0,8	BKR6EQUP	3199	BKR6EQUA	6872
A6	4.2 FSI	4200	2000->2005	8	ASG	0,8	BKR6EQUP	3199	BKR6EQUA	6872
A6	4.2 FSI	4200	2004->2006	8	BAT	0,8	BKR6EQUP	3199	BKR6EQUA	6872
A6	4.2 FSI	4200	2006->	8	BVJ	0,8	PFR6W-T	6740		
A6	4.2 QUATTRO	4200	2003->2005	8	BAS	0,8	BKR6EQUP	3199	BKR6EQUA	6872
A6	4.2 S6	4200	2002->2004	8	BCY	0,8	PFR7Q	7963	BCPR7ES	93606
A6	5.2 FSI	5200	2006->	10	BXA	0,8	PFR6W-T	6740		
A7	3.0 TDI	3000	2010->	6	CLAA/ CLAB		Y-1002AS	8926		
A7	3.0 TDI	3000	2011->	4	CGQB		Y-1002AS	8926		
A7	3.0 TDI	3000	2014->	6	CRTE		Y-1002AS	8926		
A7	3.0 TDI	3000	2014->	6	CRTF		Y-1002AS	8926		
A7	3.0 TDI	3000	2014->	6	CTCB		Y-1002AS	8926		
A7	3.0 TDI	3000	2014->	6	CTCC		Y-1002AS	8926		
A7	3.0 TDI	3000	2014->	6	CVUB		Y-1002AS	8926		
A7	3.0 TDI MULTI	3000	2011->	6	CDUC		Y-1002AS	8926		
A7	3.0 TDI SPORTBACK	3000	2014->	6	CRTD		Y-1002AS	8926		
A7	3.0 TDI SPORTBACK	3000	2014->	6	CVUA		Y-1002AS	8926		
A7	3.0 TFSI	3000	2010->	6	CGWB	0,8	PFR8S8EG	94460		
A7	3.0 TFSI	3000	2011->	6	CGXB	0,8	PFR8S8EG	94460		
A7	3.0 TFSI	3000	2014->	6	CREC	0,8	PFR8S8EG	94460		
A8	2.8 V6	2800	2007->	6	BDX	1,1	PFR6X-11	5757	BKR6ES-11	94437
A8	3.0 TDI	3000	2003->2010	6	BNG		Y-609AS	6074		
A8	3.0 TDI	3000	2004->	6	ASB		Y-609AS	6074		
A8	3.0 TDI	3000	2010->	6	CDTA		Y-1002AS	8926		
A8	3.0 TFSI	3000	2011->	6	CGXC	0,8	PFR8S8EG	94460		
A8	3.0 TFSI	3000	2010->	6	CGWA/CGXA/CMDA/CGXC	0,8	PFR8S8EG	94460		
A8	3.0 V6	3000	2004->	6	ASN/BBJ	0,8	BKR6EKUB	3584		
A8	3.2 V6	3200	2005->	6	BPK	0,8	PFR7W-T	6840		
A8	3.7 V8	3700	1997->1998	8	AEW	0,8	BUR6EFSZ	6837		
A8	3.7 V8	3700	2002->2006	8	BFL	0,8	BKR6EQUA	6872		
A8	4.0 TDI	4000	2003->2005	8	ASE		Y-501U	3786		
A8	4.2 FSI	4200	2000->2002	8	AUW	0,8	BKR6EQUP	3199	BKR6EQUA	6872
A8	4.2 FSI	4200	1998->2001	8	AQF	0,8	BKR6EQUP	3199	BKR6EQUA	6872
A8	4.2 FSI	4200	2009->	8	CDRA	0,8	PFR6W-TG	5547		



CAR • SUV • LCV



Model	Type	Capacity	Year	Cyl	Engine	Gap	Recommended	Stock Code	Alternative	Stock Code
AUDI										
A8	4.2 I	4200	1994->1999	8	ABZ	0,8	BUR6EFSZ	6837		
A8	4.2 I	4200	1999->2000	8	ARU	0,8	BKR6EQUP	3199	BKR6EQUA	6872
A8	4.2 SI	4200	2002->2006	8	BFM	0,8	BKR6EQUA	6872		
A8	4.2 SI	4200	2006->	8	BVJ	0,8	PFR6W-TG	5547		
A8	4.2 TDI	4200	2005->	8	BMC		Y-609AS	6074		
A8	4.2 TDI	4200	2009->	8	CDSB		Y-609AS	6074		
A8	5.2 FSI	5200	2006->	10	BSM	0,8	PFR6W-T	6740		
A8	6.0 FSI	6000	2004->	12	BHT	1,1	PZFR6J-11	3586	ZFR6F-11	93208
A8	6.3 W12 QUATTRO	6300	2011->	12	CEJA	0,8	ILZKR8A	94290		
CABRIO	1.8 I	1800	1997->2000	4	ADR	0,8	BKUR6ET-10	90599		
CABRIO	1.9 TDI	1900	1995->1996	4	1Z/AHU		Y-732J	5909		
CABRIO	2.0 E	2000	1993->1998	4	ABK	0,8	BUR6ET	3172		
CABRIO	2.3 E	2300	1991->1994	4	NG	0,8	BKR5EK	90426		
CABRIO	2.6 EXEC	2600	1994->2000	6	ABC	1	BKUR6ET-10	90599		
CABRIO	2.8 E COUPE	2800	1992->2000	6	AAH	1	BKUR6ET-10	90599		
Q2	1.0 TFSI	1000	2016->	3	CHZA,CHZJ	0,8	PKER7A8EGS	95463		
Q2	1.4 TFSI	1400	2013->	4	CHPB,CZDA,CZEA	0,8	PZKER7B8EGS			
Q2	2.0 TDI SPORT	2000	2015->	4	CFFB		Y-1002AS	8926		
Q3	1.4 TFSI	1400	2013->	4	CHPB	0,8	PZKER7B8EGS			
Q3	1.4 TFSI	1400	2013->	4	CZDA	0,8	PZKER7B8EGS			
Q3	1.4 TFSI	1400	2013->	4	CZEA	0,8	PZKER7B8EGS			
Q3	2.0 TDI	2000	2011->	4	CFFB		Y-1002AS	8926		
Q3	2.0 TDI	2000	2011->	4	CFGC		Y-1002AS	8926		
Q3	2.0 TFSI	2000	2011->	4	CCZC	0,8	PFR7S8EG	1675		
Q3	2.0 TFSI	2000	2011->	4	CPSA	0,8	PFR7S8EG	1675		
Q3	2.5 RS QUATTRO	2500	2014->	5	CZGA,CTSA	0,7	SILFER8C7ES	91006		
Q3	Q3 RS QUATTRO	2480	2015->2018	5	CZGA	0,7	SILFER8C7ES	91006		
Q5	3.0 R TFSI	3000	2018->	6	CWGD	0,7	SILKGR9A7ES	93560		
Q5	2.0 TDI	2000	2008->	4	CAHA, CAHB		Y-609AS	6074		
Q5	2.0 TDI	2000	2009->	4	CAGA, CAGB		Y-609AS	6074		
Q5	2.0 TDI	2000	2010->	4	CGLA,CGLB, CJCA, CMGA		Y-1002AS	8926		
Q5	2.0 TDI	2000	2012->	4	CGLC		Y-1002AS	8926		
Q5	2.0 TDI	2000	2012->	4	CGMB		Y-1002AS	8926		
Q5	2.0 TDI	2000	2013->	4	CNHA		Y-1002AS	8926		
Q5	2.0 TDI S	3000	2013->	6	CJCD		Y-1002AS	8926		
Q5	2.0 TFSI	2000	2008->	4	CDNC	0,8	PFR7S8EG	1675		
Q5	2.0 TFSI	2000	2013->	4	CNCD	0,8	PLFER7A8EG	94833		
Q5	2.0 TURBO	2000	2009->	4	CDNB	0,8	PFR7S8EG	1675		
Q5	2.0 TURBO	2000	2010->	4	CAEB	0,8	PFR7S8EG	1675		
Q5	3.0 S QUATTRO	3000	2012->	6	CGQB		Y-1002AS	8926		
Q5	3.0 TDI SE	3000	2015->	6	CTVA	0,8	PFR8S8EG	94460		
Q5	3.0 TDI	3000	2008->	6	CCWA, CCWB		Y-609AS	6074		
Q5	3.0 TDI	3000	2012->	6	CDUD		Y-1002AS	8926		
Q5	3.0 TDI	3000	2012->	6	CTBA		Y-1002AS	8926		
Q5	3.2 FSI	3200	2008->	6	CALB	1,1	PFR6X-11	5757	BKR6ES-11	94437
Q7	2.0 T QUATTRO	2000	2015->	4	CYRB	0,8	PLFER7A8EG	94833		
Q7	3.0 TDI	3000	2006->	6	BUG		Y-609AS	6074		
Q7	3.0 TDI	3000	2007->2010	6	CASA		Y-609AS	6074		
Q7	3.0 TDI	3000	2011->	6	CJGD		Y-1002AS	8926		
Q7	3.0 TDI	3000	2011->	6	CRCA		Y-1002AS	8926		
Q7	3.0 TFSI	3000	2010->	6	CJTB	0,8	PFR8S8EG	94460		
Q7	3.0 TFSI	3000	2010->	6	CJTC	0,8	PFR8S8EG	94460		
Q7	3.0 TFSI	3000	2010->	6	CJWB	0,8	PFR8S8EG	94460		
Q7	3.0 TFSI	3000	2010->	6	CJWC	0,8	PFR8S8EG	94460		
Q7	3.0 TFSI	3000	2010->	6	CNAA	0,8	PFR8S8EG	94460		
Q7	3.6 FSI	3600	2006->	6	BHK	0,8	ILZKR7A	1961	LZKAR7A	6799
Q7	3.6 QUATTRO	3600	2006->	6	BHK	0,8	ILZKR7A	1961	LZKAR7A	6799
Q7	4.2 QUATTRO	4200	2006->	8	BAR	0,8	PFR6W-TG	5547		
Q7	4.2 TDI	4200	2007->	8	BTR		Y-609AS	6074		
Q7	4.2 TDI	4200	2009->2010	8	CCFA		Y-609AS	6074		
Q7	6.0 TDI	6000	2008->	12	CCGA		Y-609AS	6074		
QUATTRO	2.2 20V	2200	1981->1988	5	WR	0,8	PFR7B	4853	BCPR7ES	93606
QUATTRO	2.2 20V	2200	1990->1992	5	3B	0,8	PFR7B	4853	BCPR7ES	93606
QUATTRO	2.2 20V S4 TURBO	2200	2001->	5	AAN	0,8	BCPR7ES	93606		
R8	4.2 FSI	4200	2007->	8	BYH	0,8	PFR7W-TG	5592		
R8	5.2 FSI	5200	2009->2010	10	BUJ	0,8	PFR7W-TG	5592		
R8	5.2 FSI	5200	2010->	10	BUJ	0,8	PFR7S8EG	1675		
R8	5.2 GT	5200	2010->	10	CMPA	0,8	PFR7S8EG	1675		
RS2	2.2 AVANT	2200	1994->1995	5	ADU	0,8	PFR7B	4853	BCPR7ES	93606
RS3	2.5 RS	2500	2017->	5	DAZA	0,7	SILFER8C7ES	91006		
RS4	2.7 BI TURBO	2700	2000->	6	ASJ	0,8	PFR7Q	7963	BCPR7ES	93606
RS4	2.7 FSI	2700	2000->2001	6	AZR	0,8	PFR7Q	7963	BCPR7ES	93606

AUDI



CAR • SUV • LCV



Model	Type	Capacity	Year	Cyl	Engine	Gap	Recommended	Stock Code	Alternative	Stock Code
AUDI										
RS4	4.2 FSI RS4	4200	2007->	8	BNS	0,8	PFR7W-TG	5592		
RS5	4.2 FSI	4200	2007->	6	CAUA	0,8	PFR6W-TG	5547		
RS5	4.2 FSI	4200	2010->	8	CFSA	0,8	PFR7S8EG	1675		
RS6	4.0 TFSI	4000	2015->	8		0,7	SILFER8C7ES	91006		
RS6	4.2 QUATTRO	4200	2003->2004	8	BCY	0,8	PFR7Q	7963	BCPR7ES	93606
RS7	4.0 QUATTRO	4000	2013->	8	CRD	0,7	SILFER8C7ES	91006		
S1	2.0 T QUATTRO	2000	2014->	4	CDLH	0,8	PFR7S8EG	1675		
S1	2.0 TFSI	2000	2014->	4	CWZA	0,8	PLFER7A8EG	94833		
S2	2.2 COUPE	2200	1991->1995	5	ABY	0,8	PFR7B	4853	BCPR7ES	93606
S3	1.8 TURBO	1800	1999->2001	4	AMK,AUL	0,8	PFR6Q	6458	BKR6E	97737
S3	1.8 TURBO	1800	1999->2001	4	APY	0,8	PFR6Q	6458	BKR6E	97737
S3	1.8 TURBO	1800	2002->2004	4	BAM	0,8	PFR6Q	6458	BKR6E	97737
S3	2.0 FSI	2000	2008->	4	CDLA	0,8	PFR7S8EG	1675		
S3	2.0 TFSI	2000	2013->	4	CJXB	0,8	PLFER7A8EG	94833		
S3	2.0 TURBO	2000	2007->2007	4	BZC	0,8	PFR7S8EG	1675		
S3	2.0 TURBO	2000	2008->	4	CDLC	0,8	PFR7S8EG	1675		
S4	2.2 T 20V	2200	1992->1995	5	AAN	0,8	BCPR7ES	93606		
S4	2.7 BI TURBO	2700	2003->	6	AGB,APB,AJK	0,8	PFR6Q	6458	BKR6E	97737
S4	3.0 QUATTRO	3000	2009->2012	6	CAKA	0,8	PFR8S8EG	94460		
S4	3.0 R TFSI	3000	2018->	6		0,7	SILKGR9A7ES	93560		
S4	3.0 TFSI	3000	2009->2012	6	CCBA/CAKA	0,8	PFR8S8EG	94460		
S4	4.2 AVANT_QUATTRO	4200	2004->	8	BBK	0,8	BKR6EQUP	3199	BKR6EQUA	6872
S4	4.2 FI	4200	2009->	6	BHF	0,8	BKR6EY	91756		
S5	3.0 FSI	3000	2009->	6	CCBA	1,1	PFR6X-11	5757	BKR6ES-11	94437
S5	3.0 R TFSI	3000	2018->	6		0,7	SILKGR9A7ES	93560		
S5	3.0 TFSI	3000	2011->	6	CMUA	0,8	PFR8S8EG	94460		
S5	4.2 FSI	4200	2007->	8	CAUA	0,8	PFR6W-TG	5547		
S6	2.2 20V	2200	2001->	5	AAN	0,8	PFR7B	4853	BCPR7ES	93606
S6	4.0 S TRONIC	4000	2012->	8	CEUC	0,7	SILFER8C7ES	91006		
S6	4.2 FSI	4200	1994->1997	8	AEC	0,8	BUR6EFSZ	6837		
S6	4.2 QUATTRO	4200	2001->2004	8	AQJ	0,8	BKR6EQUP	3199	BKR6EQUA	6872
S6	5.2 FSI	5200	2006->	10	BXA	0,8	PFR6W-T	6740		
S7	4.0 TFSI	4000	2016->	8	CEUC	0,7	SILFER8C7ES	91006		
S8	4.0 S TRONIC	4000	2013->	8	CGTA	0,7	SILFER8C7ES	91006		
S8	4.2 FSI	4200	2001->2002	8	AVP,AYS	0,8	BKR6EQUP	3199	BKR6EQUA	6872
S8	4.2 FSI	4200	2001->2004	8	AKH	0,8	BUR6EFSZ	6837		
S8	5.2 FSI	5200	2006->	10	BSM	0,8	PFR6W-T	6740		
SUPER 90	1.8 L	1800	1966->1972	4	ZD	0,8	B8ES	2411	BR8ES	5422
TT	1.8 T QUATTRO,COUPE,ROADSTER	1800	2001->	4	APX	0,8	PFR6Q	6458	BKR6E	97737
TT	1.8 TFSI	1800	2008->	4	CDAA	0,8	PFR7S8EG	1675		
TT	1.8 TURBO	1800	2000->2005	4	BAM	0,8	PFR6Q	6458	BKR6E	97737
TT	1.8 TURBO	1800	2000->2006	4	AJQ,APP,ARY	0,8	PFR6Q	6458	BKR6E	97737
TT	2.0 FSI	2000	2006->	4	BWA	0,8	PFR7S8EG	1675		
TT	2.0 FSI	2000	2008->2010	4	CDLA	0,8	PFR7S8EG	1675		
TT	2.0 FSI	2000	2008->2010	4	CDLB	0,8	PFR7S8EG	1675		
TT	2.0 FSI	2000	2010->	4	CETA	0,8	PFR7S8EG	1675		
TT	2.0 T QUATTRO	2000	2010->2013	4	CETA	0,8	PFR7S8EG	1675		
TT	2.0 TDI	2000	2008->	4	CBBB		Y-609AS	6074		
TT	2.0 TDI	2000	2010->	4	CFGB		Y-1002AS	8926		
TT	2.0 TFSI	2000	2010->	4	CCZA	0,8	PFR7S8EG	1675		
TT	2.0 TFSI	2000	2010->	4	CDMA	0,8	PFR7S8EG	1675		
TT	2.0 TFSI	2000	2010->	4	CESA	0,8	PFR7S8EG	1675		
TT	2.0 TFSI	2000	2014->	4	CHHC	0,8	PLFER7A8EG	94833		
TT	2.0 TFSI TTS	2000	2014->	4	CJXG	0,8	PLFER7A8EG	94833		
TT	2.5 RS	2500	2016->	5	DAZA	0,7	SILFER8C7ES	91006		
TT	3.2 QUATTRO	3200	2004->	6	BHE	0,8	IZKR7B	7563	ZKR7A-10	1691
TT	3.2 QUATTRO	3200	2006->	6	BUB	0,8	IZKR7B	7563	ZKR7A-10	1691

AUSTIN										
MARINA	1.3 CARB	1300	1980->	4		0,8	BP6ES	91076	BPR6ES	96989
MARINA	1.8 LS	1800	1980->	4		0,8	BP6ES	91076	BPR6ES	96989
MORRIS	1.3 L	1300	1960->	4		0,8	BP6EY	93739	BPR6EY	90310

BEDFORD										
ASTRA	1.6 D MAX	1600	1985->	4	16D OHC		Y-924J	3473		
BRAVA	2.2 4X4	2200	1998->	4			Y-306R	6244		
CF	2.0 D	2000	1979->1981	4			Y-208T	1250		
CF	2.3 D	2300	1981->	4			Y-924J	3473		



CAR • SUV • LCV



Model	Type	Capacity	Year	Cyl	Engine	Gap	Recommended	Stock Code	Alternative	Stock Code
BENTLEY										
ARNAGE	4.4 V8	4400	2001->	8	M62B44	0,8	BKR6EQUP	3199	BKR6EQUA	6872
ARNAGE	6.8 V8	6800	2002->	8	RR,R	1,1	BKR5EP-11	3440	BKR5E-11	93674
ARNAGE	6.8 V8	6800	2002->	8	T	1,1	BKR5EP-11	3440	BKR5E-11	93674
CONTINENTAL	6.0 FLYING SPUR	6000	2006->	12	W12	0,8	PFR6Q	6458	BKR6E	97737
CONTINENTAL	6.0 GT	6000	2006->	12		0,8	PFR6Q	6458	BKR6E	97737
FLYING SPUR	4.0 I	4000	2016->	8	CMMC / CYCB	0,7	SILFER8C7ES	91006		
BMW										
1 SERIES	114 I F20	1600	2011->	4	N13 B16A	0,8	PLZKBR7B8G			
1 SERIES	114 I F20	1600	2011->	4	N13B16A	0,8	PLZKBR7B8G			
1 SERIES	116 I E81	1600	2007->	4	N45 B16	0,8	BKR6EQUA	6872		
1 SERIES	116 I E87	1600	2005->	4	N45 B16	0,8	BKR6EQUA	6872		
1 SERIES	116 I F20	1600	2011->	4	N13 B16A	0,8	PLZKBR7B8G			
1 SERIES	118 I	1800	2011->	4	B43	0,8	PLZKBR7B8G			
1 SERIES	118 I E81	2000	2007->	4	N46 B20	1,1	IZFR6H-11	4294	ZFR6F-11	93208
1 SERIES	118 I E87	2000	2005->	4	N46 B20	1,1	IZFR6H-11	4294	ZFR6F-11	93208
1 SERIES	118 I F21	1600	2011->	4	N13 B16A	0,8	PLZKBR7B8G			
1 SERIES	120 D	2000	2014->	4	M47 D20		Y-547AS	6670		
1 SERIES	120 D E87	2000	2005->	4	M47 N20 D4D		Y-547AS	6670		
1 SERIES	120 I	1600	2015->	4	N13 B16A	0,8	PLZKBR7B8G			
1 SERIES	120 I E87	2000	2007->	4	N43 B20	0,8	ZKBR7A-HTU	91785		
1 SERIES	120 I E87	2000	2004->	4	N46 B20	1,1	IZFR6H-11	4294	ZFR6F-11	93208
1 SERIES	120 I E88	3000	2008->	6	N52 B30	1,1	PLZFR6A-11S	5987		
1 SERIES	120 I E88 CABRIO	2000	2008->	4	N43 B20	0,8	ZKBR7A-HTU	91785		
1 SERIES	125 I	3000	2008->	6	N52 B30	1,1	PLZFR6A-11S	5987		
1 SERIES	125 I E82	3000	2007->	6	N52 B30	1,1	PLZFR6A-11S	5987		
1 SERIES	125 I E88	3000	2008->	4	N52 B30	1,1	PLZFR6A-11S	5987		
1 SERIES	125 I F20	2000	2014->	4	N20 B20A	0,8	SILZKBR8D8S	97506		
1 SERIES	130 I E87	3000	2005->	6	N52 B30	1,1	ILZFR6D-11	6087		
1 SERIES	130 I E81	3000	2006->	6	N52 B30	1,1	ILZFR6D-11	6087		
1 SERIES	135 F21	3000	2012->	6	N55 B30A	0,8	SILZKBR8D8S	97506		
1 SERIES	135 TI E87	3000	2007->	6	N52 B30	0,8	ZKBR7A-HTU	91785		
1 SERIES	140 I M SPORT F21	3000	2016->	6	B58 B30A	0,8	SILZKGR8B8S	94201		
1 SERIES	18	1500	2015->	3		0,8	SILZKGR8C8S	95248		
2 SERIES	218 I	1800	2014->	4	B38 A15A	0,8	SILZKGR8B8S	94201		
2 SERIES	220 I F22	2000	2014->	4	N20 B20A/B	0,8	SILZKBR8D8S	97506		
2 SERIES	220 I F23	200	2014->	4	N20B20A	0,8	SILZKBR8D8S	97506		
2 SERIES	225 I	2500	2014->	4	N20 B20A	0,8	SILZKBR8D8S	97506		
2 SERIES	228 I F22	2000	2014->	4	N20 B20A	0,8	SILZKBR8D8S	97506		
2 SERIES	230 I F23	2000	2015->	4	B48 B20B	0,8	SILZKGR8B8S	94201		
2 SERIES	235 I	3000	2014->	6	N55 B30A	0,8	SILZKBR8D8S	97506		
2 SERIES	ACTIVE TOURER F45 220I	2000	2014->	4	B48 A20A,B46 A20F	0,7	SILZKGR8B8S	94201		
2 SERIES	M 240 I F23	3000	2015->	6	B58 B30A	0,8	SILZKGR8B8S	94201		
2 SERIES	MONOCAB (F45) 225I	2000	2015->2016	4	B48 A20B	0,8	SILZKGR8B8S	94201		
3 SERIES	316 I E30	1800	1987->1988	4	M40 B18	0,8	BPR5ES	94084		
3 SERIES	316 I E36	1800	1989->1993	4	M40 B16	0,8	BKR6EK	94007		
3 SERIES	316 I E36/5	1600	1996->2000	4	M43 B16	0,8	BKR6EK	94007		
3 SERIES	316 I F30	1600	2012->	4	N13B16A	0,8	PLZKBR7B8G			
3 SERIES	316 I F30	1600	2013->	4	N13 B16A	0,8	PLZKBR7B8G			
3 SERIES	316 TI E46/5	1800	2003->2004	4	N46 B18	1,1	IZFR6H-11	4294	ZFR6F-11	93208
3 SERIES	318 I E91 TOURING	2000	2006->	4	N46 B20	1,1	IZFR6H-11	4294	ZFR6F-11	93208
3 SERIES	318 I E30 TOURING	1800	1987->1994	4	M40 B18	0,8	BKR6EK	94007		
3 SERIES	318 I E46 TOURING	1900	1999->2001	4	M43 B19	0,8	BKR6EQUP	3199	BKR6EQUA	6872
3 SERIES	318 I E91	2000	2005->2007	4	M47 N204D4		Y-547AS	6670		
3 SERIES	318 I F30/F31	1500	2015->	4	B38 B15	0,8	SILZKGR8B8S	94201		
3 SERIES	318 I,IS E30	1800	1993->1999	4	M42 B18	0,8	BKR6EK	94007		
3 SERIES	318 TI E36	1900	1996-1999->	4	M44 B19	0,8	BKR6EK	94007		
3 SERIES	318 TI E46/5 COMPACT	2000	2001->2004	4	N42 B20	0,8	BKR6EQUP	3199	BKR6EQUA	6872
3 SERIES	320 CI E46	2200	2000->2005	6	M54 B22	0,8	BKR6EQUP	3199	BKR6EQUA	6872
3 SERIES	320 D E46/4	2000	2000->2005	4	M47 ND20		Y-547AS	6670		
3 SERIES	320 D E46/4	2000	2000->2001	4	M47 D20		Y-507J	6897		
3 SERIES	320 D E90	2000	2005->2007	4	M47 N204D4		Y-547AS	6670		
3 SERIES	320 D E90	2000	2010->	4	M47 D20C		Y-547AS	6670		
3 SERIES	320 D E92	2000	2006->	4	M47 N204D4		Y-547AS	6670		
3 SERIES	320 I E36	2000	1992->1996	6	M50 B20	0,8	BKR6EK	94007		
3 SERIES	320 I E90	2000	2005->	4	N46 B20	1,1	IZFR6H-11	4294	ZFR6F-11	93208
3 SERIES	320 I E91 TOURING	2000	2005->	4	N46 B20	1,1	IZFR6H-11	4294	ZFR6F-11	93208
3 SERIES	320 I E92	2000	2007->	4	N43 B20	0,8	ZKBR7A-HTU	91785		
3 SERIES	320 I CI E46	2000	1999->2000	6	M52 B20	0,8	BKR6EQUP	3199	BKR6EQUA	6872
3 SERIES	320 I E30 TOURING	2000	1982->1992	6	M20 B20	0,8	BPR5ES	94084		
3 SERIES	320 I E93	2000	2007->	4	M46 B20	1,1	IZFR6H-11	4294	ZFR6F-11	93208

BENTLEY



CAR • SUV • LCV



Model	Type	Capacity	Year	Cyl	Engine	Gap	Recommended	Stock Code	Alternative	Stock Code
BMW										
3 SERIES	320 I F30	2000	2012->	4	N20 B20A	0,8	SILZKBR8D8S	97506		
3 SERIES	320I	1998	2019->	4	B48B20B	0,8	SILZKGR8B8S	94201		
3 SERIES	323 CI E46	2500	1999->	6	M52 B25	0,8	BKR6EQU	3199	BKR6EQUA	6872
3 SERIES	323 E93	2500	2007->2012	6	N52 B25A	1,1	ILZFR6D-11	6087		
3 SERIES	323 I E30	2300	1982->1986	6	M20 B23	0,8	BP5ES	95008	BPR5ES	94084
3 SERIES	323 I E36	2500	1995->1999	6	M52 B25	0,8	BKR6EK	94007		
3 SERIES	323 I E46	2500	1999->	6	M52 B25	0,8	BKR6EQU	3199	BKR6EQUA	6872
3 SERIES	323 I E90	2500	2004->	6	N52 B25A	1,1	PLZFR6A-11S	5987		
3 SERIES	325 CI E46/2	2500	2001->	6	M54 B25	0,8	BKR6EQU	3199	BKR6EQUA	6872
3 SERIES	325 D E91	3000	2006->	6	M57 N2D30		Y-547AS	6670		
3 SERIES	325 I E92	2500	2006->	6	N52 B25A	1,1	ILZFR6D-11	6087		
3 SERIES	325 I E36 CONV	2500	1992->1995	6	M50 B25	0,8	BKR6EK	94007		
3 SERIES	325 I E46/3 TOURING	2500	2001->	6	M54 B25	0,8	BKR6EQU	3199	BKR6EQUA	6872
3 SERIES	325 I E90	2500	2005->	6	N52 B25A	1,1	ILZFR6D-11	6087		
3 SERIES	325 I E93	2500	2007->	6	N52 B25A	1,1	ILZFR6D-11	6087		
3 SERIES	325 I,S E30	2500	1986 ->1988	6	M20 B25	0,8	BPR6ES	96989		
3 SERIES	325 TD E36	2500	1991->1999	6	M51 D25		Y-924J	3473		
3 SERIES	325 TDS E36	2500	1993->1999	6	M51 D25		Y-924J	3473		
3 SERIES	325 TI E46/5 COMPACT	2500	2001->2004	6	M54 B25	0,8	BKR6EQU	3199	BKR6EQUA	6872
3 SERIES	328 I CI E46	2800	1999->	6	M52 B28	0,8	BKR6EQU	3199	BKR6EQUA	6872
3 SERIES	328 I E36	2800	1995->1999	6	M52 B28	0,8	BKR6EK	94007		
3 SERIES	328 I E46	2800	1996->1999	6	M52 B28	0,8	BKR6EK	94007		
3 SERIES	328 I F30/F31/F34	2000	2012->	4	N20 B20A	0,8	SILZKBR8D8S	97506		
3 SERIES	328 I GT F25	2800	2014->	4	N20 B20A	0,8	SILZKBR8D8S	97506		
3 SERIES	330 CD E46	3000	2003->2006	6	M57 ND30		Y-547AS	6670		
3 SERIES	330 CD E92	3000	2006->	6	M57 N2D30		Y-547AS	6670		
3 SERIES	330 CI E46/2 CONV	3000	2001->	6	M54 B30	0,8	BKR6EQU	3199	BKR6EQUA	6872
3 SERIES	330 D E46/3/4	3000	2000->2003	6	M57 D30		Y-507J	6897		
3 SERIES	330 D E90	3000	2006->	6	M57 N2D30		Y-547AS	6670		
3 SERIES	330 D E92	3000	2006->	6	M57 N2D30		Y-547AS	6670		
3 SERIES	330 D E93	3000	2007->	6	M57 N2 D30		Y-547AS	6670		
3 SERIES	330 I E90	3000	2005->	6	N52 B30	1,1	ILZFR6D-11	6087		
3 SERIES	330 I E93	3000	2007->	6	N52 B30	1,1	ILZFR6D-11	6087		
3 SERIES	330 XD E46	3000	2003->2005	6	M57 ND30		Y-547AS	6670		
3 SERIES	330 XD E46/3/4	3000	2000->2003	6	M57 D30		Y-507J	6897		
3 SERIES	333 I E30	3300	1985->1987	6	M30 B33	0,8	BPR6ES	96989		
3 SERIES	335 I E90	3000	2009->	6	N54 B30A	0,8	ZKBR7A-HTU	91785		
3 SERIES	335 I E92	3000	2006->	6	M57 N2D30		Y-547AS	6670		
3 SERIES	335 I E92	3000	2007->	6	N54 B30A	0,8	ZKBR7A-HTU	91785		
3 SERIES	335 I F21	3000	2015->	6	N55 B30A	0,8	SILZKBR8D8S	97506		
3 SERIES	340 I F30/ F31	3000	2015->	6	B58 B30	0,8	SILZKGR8B8S	94201		
3 SERIES	ACTIVEHYBRID 3	3000	2014->	6	B48 B20	0,8	SILZKGR8B8S	94201		
4 SERIES	420 I F32/F33/F36	2000	2013->	4	N20 B20A	0,8	SILZKBR8D8S	97506		
4 SERIES	420 I F32/F33/F36	2000	2015->	4	B48 B20	0,8	SILZKGR8B8S	94201		
4 SERIES	420 I F33/F32/F36	2000	2013->	4	N20 B20B	0,8	SILZKBR8D8S	97506		
4 SERIES	428 I F32/F33/F36	2000	2013->	4	N20 B20A	0,8	SILZKBR8D8S	97506		
4 SERIES	428 I F32/F33/F36	2000	2013->	4	N20 B20A	0,8	SILZKBR8D8S	97506		
4 SERIES	430 I F32/F33/F36	2000	2016->	4	B48 B20	0,8	SILZKGR8B8S	94201		
4 SERIES	440 I F32/F33/F36	3000	2016->	6	B58 B30	0,8	SILZKGR8B8S	94201		
5 SERIES	1.8 E12	1800	1975->1984	4	M10 B18	0,8	BPR6ES	96989		
5 SERIES	518 E12	2000	1979->1982	4	M10 B20	0,8	BPR6ES	96989		
5 SERIES	518 I E28	2000	1982->1985	4	M10 B18	0,8	BPR6ES	96989		
5 SERIES	520 D E60	2000	2005->2007	4	M47 N204D4		Y-547AS	6670		
5 SERIES	520 D E61	2000	2005->	4	M47 N204D4		Y-547AS	6670		
5 SERIES	520 E12	2000	1982->1985	6	M10 B20	0,8	BPR5ES	94084		
5 SERIES	520 I E34	2000	1982->1990	6	M20 B20	0,8	BPR6ES	96989		
5 SERIES	520 I E34	2000	1990->1994	6	M50 B20	0,8	BKR6EK	94007		
5 SERIES	520 I F10/F11	2000	2013->	4	N20 B20A	0,8	SILZKBR8D8S	97506		
5 SERIES	520 I F10/F11	2000	2014->	4	N20 B20A	0,8	SILZKBR8D8S	97506		
5 SERIES	520 I F11	2000	2011->	4	N20 B20A	0,8	SILZKBR8D8S	97506		
5 SERIES	520 I F11	2000	2011->	4	N20 B20B	0,8	SILZKBR8D8S	97506		
5 SERIES	520I	1998	2017->	4	B48B20A	0,8	SILZKBR8D8S	97506		
5 SERIES	523 F10	3000	2010->	6	N53 B30	0,5	ZKBR7A-HTU	91785		
5 SERIES	523 F11	3000	2010->	6	N53 B30	0,5	ZKBR7A-HTU	91785		
5 SERIES	523 I E39	2500	1996->	6	M52 B25	0,8	BKR6EK	94007		
5 SERIES	523 I E39	2500	1998->2000	6	M52 B25	0,8	BKR6EQU	3199	BKR6EQUA	6872
5 SERIES	523 I E60	2500	2004->2006	6	N52 B25	1,1	ILZFR6D-11	6087		
5 SERIES	523 I E61	2500	2005->	6	N52 B25	1,1	ILZFR6D-11	6087		
5 SERIES	523 I F10	2500	2010->	6	N52N B25A	1,1	LZFR6AP11GS	95712		
5 SERIES	523 I F10	3000	2010->	6	N53 B30	0,8	ZKBR7A-HTU	91785		
5 SERIES	523 I F11	2500	2010->2011	6	N52N B25A	1,1	LZFR6AP11GS	95712		
5 SERIES	525 D E39/2	2500	2000->2003	6	M57 D25		Y-507J	6897		

BMW



CAR • SUV • LCV



Model	Type	Capacity	Year	Cyl	Engine	Gap	Recommended	Stock Code	Alternative	Stock Code
BMW										
5 SERIES	525 D E61	2500	2004->	6	M57 ND25		Y-547AS	6670		BMW
5 SERIES	525 E E28	2700	1986->1989	6	M20 B27	0,8	BPR5ES	94084		
5 SERIES	525 E60	2500	2004->	6	N52 B25	1,1	ILZFR6D-11	6087		
5 SERIES	525 I E34	2500	1989->1990	6	M20 B25	0,8	BPR6ES	96989		
5 SERIES	525 I E34	2500	1990->1996	6	M50 B25	0,8	BKR6EK	94007		
5 SERIES	525 I E39	2500	2001->	6	M54 B25	0,8	BKR6EQUP	3199	BKR6EQUA	6872
5 SERIES	525 I E60	2500	2003->2004	6	M54 B25	0,8	BKR6EQUP	3199	BKR6EQUA	6872
5 SERIES	525 I E60	2500	2007->	6	N52 B25	0,8	ZKBR7A-HTU	91785		
5 SERIES	525 I E61	2500	2004->	6	N52 B25	1,1	ILZFR6D-11	6087		
5 SERIES	525 I E61N	2500	2007->	6	N52 B25	0,8	ZKBR7A-HTU	91785		
5 SERIES	525 TDI E34/39	2500	1992->1996	6	M51 D25		Y-924J	3473		
5 SERIES	528 F10	3000	2010->	6	N53 B30A	0,8	ZKBR7A-HTU	91785		
5 SERIES	528 F10	3000	2010->2011	6	N53 B30A	0,8	ZKBR7A-HTU	91785		
5 SERIES	528 I E28	2800	1978->1989	6	M30 B28	0,8	BPR5ES	94084		
5 SERIES	528 I E39	2800	1996->2000	6	M52 B28	0,8	BKR6EK	94007		
5 SERIES	528 I F11	2000	2011->	4	N20 B20A	0,8	SILZKBR8D8S	97506		
5 SERIES	530 D E39/2	3000	1999->2004	6	M57 D30		Y-507J	6897		
5 SERIES	530 D E61	3000	2005->	6	M57 N2D30		Y-547AS	6670		
5 SERIES	530 I E12	3000	1977->1980	6	M30 B30	0,8	BPR5ES	94084		
5 SERIES	530 I E34	3000	1993->1996	8	M60 B30	0,8	BKR6EK	94007		
5 SERIES	530 I E39/2	3000	2001->	6	M54 B30	0,8	BKR6EQUP	3199	BKR6EQUA	6872
5 SERIES	530 I E60 TOURING	3000	2003->2004	6	M54 B30	0,8	BKR6EQUP	3199	BKR6EQUA	6872
5 SERIES	530 I E61	3000	2005->	6	N52 B30	1,1	ILZFR6D-11	6087		
5 SERIES	530 I F10	3000	2011->2013	6	N52N B30BF	1,1	LZFR6AP11GS	95712		
5 SERIES	530 I F11	3000	2011->2013	6	N52N B30A	1,1	LZFR6AP11GS	95712		
5 SERIES	530 I F11	3000	2011->2013	6	N52N B30AF	1,1	LZFR6AP11GS	95712		
5 SERIES	535 F10	3000	2010->	6	N55 B30A	0,8	SILZKBR8D8S	97506		
5 SERIES	535 GT	3000	2012->	6	N55 B30A	0,8	SILZKBR8D8S	97506		
5 SERIES	535 I E34	3500	1985->1994	6	M30 B35	0,8	BPR5ES	94084		
5 SERIES	540 I E34	4000	1993->1996	8	M60 B40	0,8	BKR6EK	94007		
5 SERIES	540 I E39 TOURING	4400	1998->	8	M62 B44	0,8	BKR6EQUP	3199	BKR6EQUA	6872
5 SERIES	545 I E60	4400	2004->	8	N62 B44	0,8	BKR6EQUP	3199	BKR6EQUA	6872
5 SERIES	550 F10	4400	2010->	6	N63 B44B	0,8	SILZKBR8D8S	97506		
5 SERIES	550 GT	4500	2012->	8	N63 B44B	0,8	SILZKBR8D8S	97506		
5 SERIES	550 I E60	4800	2005->	8	N62 B48	1,1	IZFR6H-11	4294	ZFR6F-11	93208
5 SERIES	550 I F10	4400	2011->	4	N20 B20A	0,8	SILZKBR8D8S	97506		
5 SERIES	550 I F11	4400	2011->	4	N20 B20A	0,8	SILZKBR8D8S	97506		
5 SERIES	550 I F11	4400	2013->	8	N63 B44B	0,8	SILZKBR8D8S	97506		
5 SERIES	ACTIVEHYBRID 5 F10	3000	2012->	6	N55 B30A	0,8	SILZKBR8D8S	97506		
6 SERIES	635 CSI E24	3400	1982->1988	6	M30 B34	0,8	BPR5ES	94084		
6 SERIES	640 I F06	3000	2012->	6	N55 B30A	0,8	SILZKBR8D8S	97506		
6 SERIES	640 I GT G32	3000	2017->	6	B58 B30A	0,8	SILZKGR8B8S	94201		
6 SERIES	645 CI E63	4400	2004->2005	8	N62 B44	0,8	BKR6EQUP	3199	BKR6EQUA	6872
6 SERIES	650 CI E64	4800	2005->	8	N62 B48	1,1	IZFR6H-11	4294	ZFR6F-11	93208
6 SERIES	650 F12	4400	2011->2012	8	N64 B44A	0,8	SILZKBR8D8S	97506		
6 SERIES	650I	4395	2011->2017	8	N63B44A	0,8	SILZKBR8D8S	97506		
7 SERIES	728,728I E23	2800	1978->1987	6	M30 B28	0,8	BPR5ES	94084		
7 SERIES	730 D E65	3000	2001->2005	6	M57 D30		Y-507J	6897		
7 SERIES	730 D F01	3000	2009->	6	N57 D30A		Y-547AS	6670		
7 SERIES	730 E23	3000	1978->1980	6	M30 B30	0,8	BPR5ES	94084		
7 SERIES	730 I E32	3000	1987->1992	6	M30 B30	0,8	BPR5ES	94084		
7 SERIES	730 I E32	3000	1991->1994	6	M30 B30	0,8	ZGR5A	5839		
7 SERIES	730 I E38	3000	1993->1994	8	M60 B30	0,8	BKR6EK	94007		
7 SERIES	730 I F01/F02	3000	2010->2015	6	N52 B30A	1,1	LZFR6AP11GS	95712		
7 SERIES	733 I E23	3300	1980->1984	6	M30 B32	0,8	BPR5ES	94084		
7 SERIES	735 I E32	3400	1986->1992	6	M30 B35	0,8	BPR5ES	94084		
7 SERIES	735 I E38	3500	1998->	8	M62 B35	0,8	BKR6EQUP	3199	BKR6EQUA	6872
7 SERIES	735 I E65	3600	2002->2005	8	N62 B36	0,8	BKR6EQUP	3199	BKR6EQUA	6872
7 SERIES	740 E DRIVE G11/G12	3000	2016->	6	B48 B20	0,8	SILZKGR8B8S	94201		
7 SERIES	740 I E32	4000	1993->1996	8	M60 B40	0,8	BKR6EK	94007		
7 SERIES	740 I E38	4400	1997->2002	8	M62 B44	0,8	BKR6EK	94007		
7 SERIES	740 I E65	4000	2005->	8	N62 B40A	1,1	IZFR6H-11	4294	ZFR6F-11	93208
7 SERIES	740 I F01	3000	2009->	6	N53 B30A	0,8	SILZKBR8D8S	97506		
7 SERIES	740I G12	3000	2015->	6	B58 B30	0,8	SILZKGR8B8S	94201		
7 SERIES	745 I E23	3500	1984->1987	6	M88 B35	0,7	D7EA	7912	DR7EA	7839
7 SERIES	745 LI E65	4400	2002->2005	8	N62 B44	0,8	BKR6EQUP	3199	BKR6EQUA	6872
7 SERIES	750 I E32	5000	1988->1994	12	M70 B50	1,1	ZFR5F-11	93814		
7 SERIES	750 I E38	5400	1999->	12	M73 B54	0,8	BKR6EQUP	3199	BKR6EQUA	6872
7 SERIES	750 I E65	4800	2007->	8	N62 B48	1,1	IZFR6H-11	4294	ZFR6F-11	93208
7 SERIES	750 I F01	4500	2009->	8	N63 B44A	0,8	SILZKBR8D8S	97506		
7 SERIES	750I	4395	2012->	8	N63B44B	0,8	SILZKBR8D8S	97506		
7 SERIES	760 F02	6000	2009->	12	N74 B60A	0,8	SILZKBR8D8S	97506		



CAR • SUV • LCV

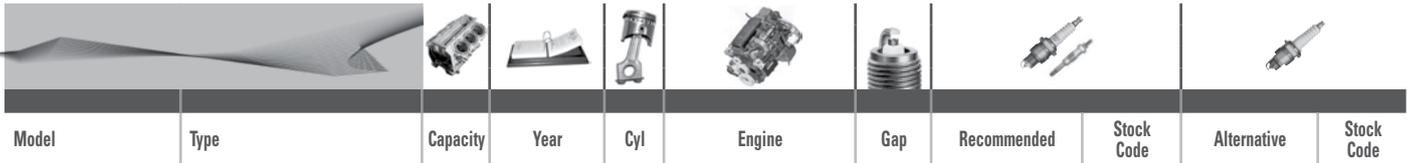

Model	Type	Capacity	Year	Cyl	Engine	Gap	Recommended	Stock Code	Alternative	Stock Code
BMW										
7 SERIES	760 I E65	6000	2004->2007	12	N73 B60	0,8	BKR6EQU	3199	BKR6EQUA	6872
7 SERIES	760LI X DRIVE	6592	2016->		N74B66	0,8	SILZKBR8D8S	97506		
7 SERIES	ACTIVEHYBRID 7 F01	3000	2012->	6	N55 B30A	0,8	SILZKBR8D8S	97506		
7 SERIES	M760 LI G11,G12	6600	2016->	12	N74 B66B	0,8	SILZKBR8D8S	97506		
8 SERIES	850 I E31	5000	1992->1994	12	M70 B50	1,1	ZFR5F-11	93814		
8 SERIES	E31 850 CSI	5000	1994->	12	M73	1,1	ZFR4F-11	4043		
M2	M2 3.0 I F22	3000	2012->	6	N55 B30A	0,8	SILZKBR8D8S	97506		
M3	M3 3.0 I	3000	2013->	6	S55 B30A	0,8	SILZKBR8D8S	97506		
M3	M3 E36	3000	1992->1995	6	S50 B30	0,8	PKR7A	3641	DCPR7E	3932
M3	M3 E36	3200	1995->1999	6	S50 B32	0,8	PKR7A	3641	DCPR7E	3932
M3	M3 E46	3200	2001->2006	6	S54 B32	0,8	DCPR8EK	7415	DCPR8EKC	7168
M3	M3 E90	4000	2007->	8	S65 B40	0,8	LKR8AP	4471	LKR8A	5214
M3	M3 E92	4000	2007->	8	S65 B40	0,8	LKR8AP	4471	LKR8A	5214
M3	M3 E93	4000	2007->	8	S65 B40	0,8	LKR8AP	4471	LKR8A	5214
M4	M4 3.0 I F33/F83	3000	2014->	6	S55 B20A	0,8	SILZKBR8D8S	97506		
M5	M5 2017	4395	2017->	8	S63B44B	0,8	SILZKBR8D8S	97506		
M5	M5 4.4 I F10	4400	2013->	8	S63 B44B	0,8	SILZKBR8D8S	97506		
M5	M5 E28	3500	1981->1985	6	M90 B35	0,8	BPR5ES	94084		
M5	M5 E28	3500	1985->1987	6	S38 B35	0,7	DR7EA	7839		
M5	M5 E39	5000	1998->2003	8	S62 B50	0,8	BKR6EQU	3199	BKR6EQUA	6872
M5	M5 E60	5000	2007->	10	S85 B50A	0,8	LKR8AP	4471	LKR8A	5214
M6	M6 4.4 I F12	4400	2014->	8	S63 B44B	0,8	SILZKBR8D8S	97506		
M6	M6 E63	5000	2004->2007	10	S85 B50	0,8	LKR8AP	4471	LKR8A	5214
M6	M6 E64	5000	2005->	10	S85 B50	0,8	LKR8AP	4471	LKR8A	5214
X1	X1 1.6 I SDRIVE	2000	2013->	4	N20 B16B	0,8	SILZKBR8D8S	97506		
X1	X1 1.8 XDRIVE E84	1800	2012->	4	N46 B20	1,1	IZFR6H-11	4294	ZFR6F-11	93208
X1	X1 1.8I E84	2000	2009->	4	N46 B20	1,1	IZFR6H-11	4294	ZFR6F-11	93208
X1	X1 2.0 D S DRIVE E84	2000	2012->	4	N47 D20C		Y-547AS	6670		
X1	X1 2.0 S DRIVE F25	2000	2011->	4	N20 B20A	0,8	SILZKBR8D8S	97506		
X1	X1 2.8 X DRIVE	3000	2013->	6	N52N B30A	1,1	LZFR6AP11GS	95712		
X1	X1 2.8I E84	3000	2009->	6	N52 B30	1,1	PLZFR6A-11S	5987		
X1	X1 F48 SDRIVE20.I	2000	2015->	4	B48 A20A, B48 A20F	0,8	SILZKGR8B8S	94201		
X1	X1 F48 XDRIVE 25I	2000	2015->	4	B42S20A, B46 A20, B48 A20B	0,8	SILZKGR8B8S	94201		
X3	X3 2.0 D E83	2000	2005->	4	M47 N D20		Y-547AS	6670		
X3	X3 2.0 I F25	1600	2011->	4	N20B16A	0,8	SILZKBR8D8S	97506		
X3	X3 2.0 X DRIVE	2000	2013->	4	N20 B20A	0,8	SILZKBR8D8S	97506		
X3	X3 2.0I E83	2000	2005->	4	N46 B20	1,1	IZFR6H-11	4294	ZFR6F-11	93208
X3	X3 2.5I E83	2500	2004->	6	M54 B25	0,8	BKR6EQU	3199	BKR6EQUA	6872
X3	X3 2.5I E83	2500	2005->	6	M54 B25	0,8	BKR6EQU	3199	BKR6EQUA	6872
X3	X3 2.5I E84	3000	2009->	6	N52 B30	1,1	PLZFR6A-11S	5987		
X3	X3 2.5SI E83	2500	2006->	6	N52 B25	1,1	ILZFR6D-11	6087		
X3	X3 2.8 X DRIVE F25	2000	2013->	4	N20 B20A	0,8	SILZKBR8D8S	97506		
X3	X3 3.0D E83	3000	2006->	6	M57 N2 D30		Y-547AS	6670		
X3	X3 3.0I E70	3000	2007->	6	N52 B30	1,1	ILZFR6D-11	6087		
X3	X3 3.0I E83	3000	2004->	6	M54 B30	0,8	BKR6EQU	3199	BKR6EQUA	6872
X3	X3 3.0I E83	3000	2004->	6	M54 B30	0,8	BKR6EQU	3199	BKR6EQUA	6872
X3	X3 3.0SI E83	3000	2006->	6	N52 B30	1,1	ILZFR6D-11	6087		
X3	X3 3.5 X DRIVE F25	3000	2012->	6	N55 B30A	0,8	SILZKBR8D8S	97506		
X4	X4 2.0 X DRIVE F26	2000	2014->	4	N20 B20A	0,8	SILZKBR8D8S	97506		
X4	X4 2.8 X DRIVE F26	2800	2014->	6	N20 B20A	0,8	SILZKBR8D8S	97506		
X5	X5 3.0D E53	3000	2001->2003	6	M57 D30		Y-507J	6897		
X5	X5 3.0D E53	3000	2004->	6	M57 N D30		Y-547AS	6670		
X5	X5 3.0D E70	3000	2007->	6	M57 N2 D30		Y-547AS	6670		
X5	X5 3.0I E53	3000	1999->2006	6	M54 B30	0,8	BKR6EQU	3199	BKR6EQUA	6872
X5	X5 3.0I E53	3000	2001->	6	M54 B30	0,8	BKR6EQU	3199	BKR6EQUA	6872
X5	X5 3.0I E70	3000	2007->	6	N52 B30	1,1	ILZFR6D-11	6087		
X5	X5 3.5 X DRIVE E70	3000	2010->	6	N55 B30A	0,8	SILZKBR8D8S	97506		
X5	X5 4.0E XDRIVE F15	2000	2014->	4	N20 B20A	0,8	SILZKBR8D8S	97506		
X5	X5 4.0E XDRIVE F15	2000	2014->	4	N20 B20A	0,8	SILZKBR8D8S	97506		
X5	X5 4.4I E53	4400	2001->2004	8	M62 B44	0,8	BKR6EQU	3199	BKR6EQUA	6872
X5	X5 4.4I E53	4400	2003->2006	8	N62 B44	0,8	BKR6EQU	3199	BKR6EQUA	6872
X5	X5 4.6IS E53	4600	2003->2004	8	M62 B46	0,8	BKR6EQU	3199	BKR6EQUA	6872
X5	X5 4.8I E53	4800	2003->2006	8	N62 B48	1,1	IZFR6H-11	4294	ZFR6F-11	93208
X5	X5 4.8I E70	4800	2007->	8	N62 B48	1,1	IZFR6H-11	4294	ZFR6F-11	93208
X5	X5 4.8IS E53	4800	2004->2007	8	N62 B48	1,1	IZFR6H-11	4294	ZFR6F-11	93208
X5	X5 50I	7395	2015->2018		N63B44B	0,8	SILZKBR8D8S	97506		
X5	X5 5.0 X DRIVE E70	4400	2010->	8	N63 B44A	0,8	SILZKBR8D8S	97506		
X5	X5 M 4.4 I F15, F85	4400	2014->	8	S63 B44B	0,8	SILZKBR8D8S	97506		
X6	50I XDRIVE	4395	2008->2014	8	N63B44A	0,8	SILZKBR8D8S	97506		
X6	X6 3.0I E71	3000	2008->	6	N54 B30	1,1	IZFR6H-11	4294	ZFR6F-11	93208
X6	X6 4.4 M	4400	2012->	8	S63 B44A	0,8	SILZKBR8D8S	97506		
Z SERIES	Z3 E36	3000	2000->2003	6	M54 B30	0,8	BKR6EQU	3199	BKR6EQUA	6872



CAR • SUV • LCV



Model	Type	Capacity	Year	Cyl	Engine	Gap	Recommended	Stock Code	Alternative	Stock Code
BMW										
Z SERIES	Z3 E36 COUPE	3200	1997->2001	6	S50 B32	0,8	PKR7A	3641	DCPR7E	3932
Z SERIES	Z3 E36 ROADSTER	2800	1997->2000	6	M52 B28	0,8	BKR6EK	94007		
Z SERIES	Z4 1.8 I E89	2000	2014->	4	N20 B20A	0,8	SILZKBR8D8S	97506		
Z SERIES	Z4 20I SDRIVE	1998	2018->	4	B48B20B		SILZKG7B8S			
Z SERIES	Z4 2.0 I SDRIVE	2000	2012->	4	N20 B20A	0,8	SILZKBR8D8S	97506		
Z SERIES	Z4 E85	2000	2005->	4	N46 B20	1,1	IZFR6H-11	4294	ZFR6F-11	93208
Z SERIES	Z4 E85	2500	2003->	6	M54 B25	0,8	BKR6EQUP	3199	BKR6EQUA	6872
Z SERIES	Z4 E85	2500	2007->	6	N52 B25	1,1	ILZFR6D-11	6087		
Z SERIES	Z4 E85	3000	2003->	6	M54 B30	0,8	BKR6EQUP	3199	BKR6EQUA	6872
Z SERIES	Z4 E85	3200	2006->	6	S54 B32	0,8	DCPR8EKP	7415	DCPR8EKC	7168
Z SERIES	Z4 E86	3000	2005->2007	6	N52 B30	1,1	ILZFR6D-11	6087		
Z SERIES	Z4 E86	3200	2005->2007	6	S54 B32	0,8	DCPR8EKP	7415	DCPR8EKC	7168
Z SERIES	Z4 E89	2500	2008->	6	N54 B25	1,1	PLZFR6A-11S	5987		
Z SERIES	Z4 E89	3000	2008->	6	N54 B30	1,1	PLZFR6A-11S	5987		
Z SERIES	Z8 E52	5000	2004->	8	S62 B50	0,8	BKR6EQUP	3199	BKR6EQUA	6872
BORGWARD										
DER GROSSE	2.3	2300	1960->1961	6		0,8	B6HS	4510	BR6HS	3922
HANSA	1.1	1100	1950->1960	4		0,8	B7HS	5110	BR7HS	4122
HANSA	1.5	1100	1950->	4		0,8	B6HS	4510	BR6HS	3922
HANSA	1.8	1800	1950->	4		0,8	B6HS	4510	BR6HS	3922
HANSA 2400	2.2	2200	1956->1958	6	6M2.3	0,8	B7HS	5110	BR7HS	4122
HANSA 2400	2.3	2300	1956->1958	6		0,8	B7HS	5110	BR7HS	4122
HANSA 2400	2.3	2300	1952->1955	6	6M2.4	0,8	B7HS	5110	BR7HS	4122
HANSA COUPE	1.1	1100	1950->1960	4		0,8	B8HS	5510	BR8HS	4322
ISABELLA	1.5	1500	1954->1958	4	4M1.5	0,8	B6HS	4510	BR6HS	3922
ISABELLA TS	1.5 TS	1500	1954->1958	4	4M1.5	0,8	B7HS	5110	BR7HS	4122
BUICK										
ENCLAVE	3.6 CX	3600	2009->	6	V6 D FI	1,1	ILTR6E-11	90117		
LACROSSE	3.6 FI	3600	2005->	6	V6 2 FI	1,5	TR55IX	7164	TR6IX	3689
LACROSSE	3.6 FI	3600	2005->	6	V6 7 FI 217	0,8	ILTR6A-8G	3787	TR6B-10	94480
LACROSSE	3.8 CXL	3800	2009->	6	V6 2 FI	1,5	ITR4A-15	5599		
LUCERNE	3.9 CXL	3900	2009->	6	V6 1 FI	1,1	IZTR4A-11	4213		
LUCERNE	4.6 CXL	4600	2009->	8	V8 9 FI	0,8	TR7IX	3690		
CADILLAC										
BLS	1.9 D	1900	2006->	4	Z19DTH		YE07	6092		
CTS	2.0 T	2000	2014->	4		0,9	ILTR6M9G	94489		
CTS	3.6 V6	3600	2008->	6	7FI	1,1	LTR6IX-11	6509	LTR7IX-11	6510
ESCALADE	6.2 LI	6200	2006->2007	8	L92	1,5	TR55IX	7164	TR6IX	3689
SEVILLE STS	4.6 SI	4600	2000->	8		1,3	PTR5C-13	7740	BPR5EFS-13	2359
SRX	3.6 I V6	3600	2006->	6		0,8	ILTR6A-8G	3787	TR6B-10	94480
CAM										
INYATHI	2.2 I	2200	2006->	4	SF491QE	0,8	BPR6ES	96989		
LEO	2.2 L	2200	2006->	4	SF491QE	0,8	BPR6ES	96989		
LEOPARD	2.2 L	2200	2006->	4	SF491QE	0,8	BPR6ES	96989		
RHINO	2.2 L	2200	2006->	4	SF491QE	0,8	BPR6ES	96989		
CHANA										
BENNI	1.3 I	1300	2008->	4	JL474Q2	0,8	BCPR6ES	96990	BCP6ES	94000
CHANA	1.0 L	1000	2006->	4	JL465Q5	0,8	BPR6ES	96989		
CHANA	1.3 S	1300	2006->	4	JL474Q	0,8	BCPR6ES	96990	BCP6ES	94000
MAXI-STAR	1.3 H	1300	2007->	4		0,8	BCPR7ES	93606	BCP7ES	5030
RAINBOW	1.0 I	1000	2007->	4		0,8	BPR6ES	96989		
RAINBOW	1.3 I	1300	2007->	4		0,8	BCPR7ES	93606		
STAR	1.0 L	1000	2006->	4		0,8	BPR6ES	96989		
STAR	1.3 H	1300	2006->	4		0,8	BCPR7ES	93606	BCP7ES	5030
CHANGAN										
CS75	1.5 TURBO	1500	2014->	4	JL4762QCA	1,1	SIFR6B7G	94675	SIFR6A-11	127
CS75	1.8 TURBO	1800	2014->	4	JL4876QCA	1,1	SIFR6B7G	94675	SIFR6A-11	127
CS75	2.0	2000	2014->	4	JL486Q5	1,1	SIFR6B7G	94675	SIFR6A-11	127
STAR	1.0 I	1000	2000->	4	JL472Q	0,8	BKR5ES	90841		
STAR	1.3 I	1300	2004->	4	JL474Q	0,8	BKR6E	97737		



CAR • SUV • LCV



Model	Type	Capacity	Year	Cyl	Engine	Gap	Recommended	Stock Code	Alternative	Stock Code
CHERY										
J1	1.3 TE	1300	2011->	4	S2X	1,1	BKR6E-11	94306		
J2	1.5 I	1500	2012->	4	SQR477F	0,8	BKR6E	97737		
J3	1.6 TXE	1600	2011->	4	M1X	0,8	BCPR7ET	2164		
J5	2.0 I	2000	2008->	4		0,8	BCPR6ET	2197		
QQ3	0.8 I	800	2008->	3	SQR372	1,1	BKR5E-11	93674		
QQ3	1.1 I	1100	2008->	4		1,1	BKR5E-11	93674		
TIGGO	1.6	1600	2010->	4	SQR481FG	0,8	BCPR6ET	2197		
TIGGO	2.0 I	2000	2008->	4		0,8	BCPR6ET	2197		

CHEVROLET										
Model	Type	Capacity	Year	Cyl	Engine	Gap	Recommended	Stock Code	Alternative	Stock Code
308	5.0 V8	5000	1989->	8		0,8	BPR5FS-15	3124		
ASCONA	1.3 S	1300	1978->1981	4		0,8	BPR6ES	96989		
AVEO	1.2 I	1200	2008->	4	B12D1	0,8	DCPR8E	4339		
AVEO	1.4 16V	1400	2005->2008	4	F14D3	1,1	BKR6E-11	94306		
AVEO	1.4 MFI	1400	2008->	4	A14XER	1,1	ZFR6F-11	93208		
AVEO	1.5 I	1500	2003->	4	F15S3	1,1	BPR6ES-11	94967		
AVEO	1.6 I	1600	2006->2008	4	F16D	1,1	BKR6E-11	94306		
AVEO	1.6 I	1600	2010->	4	L4	1,1	ZFR6F-11	93208		
AVEO	1.6 LT	1600	2009->	4	L4 EFI	1,1	ZFR6F-11	93208		
BLAZER	4.3 V6	4300	2003->2003	6	EFI	1,5	TR55IX	7164	TR6IX	3689
BLAZER	5.7 V8	5700	1994->	8	EFI	0,8	BPR6FS	2623		
C10	4.1 LCV	4100	1974->1980	6		0,8	BPR5ES	94084		
C20	4.1 LCV	4100	1974->1980	6		0,8	BPR5ES	94084		
CAPTIVA	2.2 D	2200	2012->	4	Z22D1		Y-8010AS	93503		
CAPTIVA	2.4 I	2400	2006->	4	Z24SED	0,8	BKR5EK	90426		
CAPTIVA	2.4 LT	2400	2006->	4	Z24SED	0,8	BKR5EK	90426		
CAPTIVA	3.0 I	3000	2012->	6	A30XH		ILTR6E-11	90117		
CAPTIVA	3.0 LTZ	3000	2012->	6	LF	1,1	LTR6IX-11	6509	LTR7IX-11	6510
CAPTIVA	3.2 V6	3200	2006->	6	Z32SED	1,3	PTR5A-13	2467	TR5B-13	97667
CAVALIER	2.2 S	2200	2005->	4	L4	1,3	PTR5C-13	7740	BPR5EFS-13	2359
CHEVAIR	1.6 L	1600	1980->1982	4		0,6	BP6HS	4511	BPR6HS	7022
CHEVAIR	2.0 DL	2000	1976->1980	4		0,8	BPR5ES	94084		
CHEVAIR	2.3 GL,SR	2300	1976->1981	4		0,8	BPR5ES	94084		
COMMODORE	3.8 S/WAGON	3800	1978->1982	6		0,8	BPR5ES	94084		
COMMODORE	4.1 GL	4100	1978->1982	6		0,8	BPR5ES	94084		
CORVETTE	5.7 V8 FI	5700	2001->2003	8	G, EFI	1,5	TR55IX	7164	TR6IX	3689
CORVETTE	5.7 V8	5700	1996->2000	8	EFI	1,5	TR55IX	7164	TR6IX	3689
CORVETTE	5.7 V8 FI	5700	2003->2004	8		1,5	PZTR5A-15	7862	TR5B-13	97667
CORVETTE	6.0 V8 FI	6000	2005->	8		1,5	PZTR5A-15	7862	TR5B-13	97667
CROSSFIRE	3.2 V6 EFI	3200	2006->	6		1,1	PFR5J-11	4642	BKR5E-11	93674
CRUZE	1.4 I	1400	2009->	4	A14XER	1,1	ZFR6F-11	93208		
CRUZE	1.4 I	1400	2014->	4		0,7	IFR6Z7G	95609		
CRUZE	1.4 T	1400	2012->	4	A14NET	0,7	IFR7X-7G	91039		
CRUZE	1.6 I	1600	2003->2005	4	F16D3	1,1	BKR6E-11	94306		
CRUZE	1.6 I	1600	2009->2012	4	F16D4	1,1	ZFR6F-11	93208		
CRUZE	1.6 I	1600	2009->2012	4	F16D4	1,1	ZFR6F-11	93208		
CRUZE	1.6 I	1600	2013->	4	LDE		ZFR6U-9	90318		
CRUZE	1.8 I	1800	2009->	4	F18D4	0,9	ZFR6U-9	90318		
CRUZE	1.8 I	1800	2011->2015	4	F18D4	1,1	ZFR6F-11	93208		
CRUZE	2.0 D LS	2000	2012->	4	Z20S1		Y-8009AS	96478		
LUMINA	2.2 I	2200	2004->	4		1,1	IZFR6K-11	6994	ZFR6K-11	6711
LUMINA	3.7 I	3700	2005->	6	LY7	1,5	BPR6EFS-15	4871		
LUMINA	3.7 LI	3700	2005->	6	LEO	1,3	BPR6EF-13	2402		
LUMINA	3.8 FI	3800	2003->	8		0,8	BPR6EFS	92170		
LUMINA	5.7 SS	5700	2003->	8		1,3	TR55IX	7164	BPR5EFS-13	2359
LUMINA	6.0 SS	6000	2007->	8		1,5	TR55IX	7164	TR6IX	3689
LUV	1.6 LCV	1600		4		0,8	BPR6ES	96989		
NOMAD	2.5 L	2500	1976->1980	4		0,8	BPR5ES	94084		
OPTRA	1.6 LS	1600	2004->	4	F16D	1,1	BKR6E-11	94306		
OPTRA	1.8 LT	1800	2004->	4	T18SED	0,8	BKR5EK	90426		
ORLANDO	1.8 I	1800	2011->	4	2H0	1,1	ZFR6U-9	90318		
REKORD	2.0 GL	2000	1980->1982	4		0,6	BP6HS	4511	BPR6HS	7022
REKORD	2.3 GL,L	2300	1978->1981	4		0,8	BPR5ES	94084		
SENATOR	4.1 LT	4100	1979->1982	6		0,8	BPR5ES	94084		
SONIC	1.3 D	1300	2012->	4	LSF		Y-9001AS	93707		
SONIC	1.4 I	1400	2012->	4	14XER	1,1	ZFR6V-G	8894		
SONIC	1.6 I	1600	2012->	4	F16D4	1,1	ZFR6F-11	93208		
SPARK	0.8 LS	800	2003->2005	3	F8CV	1,1	BPR5EY-11	95989		
SPARK	1.0 L	1000	2005->	4	B10S	1,1	BPR5EY-11	95989		
SPARK	1.2 L	1200	2011->	4	B12D1	0,8	DCPR8E	4339		
TAHOE	5.3 V8 FI	5300	2006->	8	LY5	1,5	TR55IX	7164	TR6IX	3689



CAR • SUV • LCV



Model	Type	Capacity	Year	Cyl	Engine	Gap	Recommended	Stock Code	Alternative	Stock Code
-------	------	----------	------	-----	--------	-----	-------------	------------	-------------	------------

CHEVROLET

CHEVROLET

CHEVROLET

TAHOE	5.7 I V8	5700	1996->2000	8	R V8	1,5	TR55IX	7164	BPR6EFS	92170
TRAILBLAZER	2.8 D LTZ	2800	2012->	4	LWH		Y8011AS	90403		
TRAILBLAZER	3.6 V6 LTZ	3600	2012->	6		1,1	LTR6IX-11	6509	LTR7IX-11	6510
UTILITY	1.3 DT	1300	2006->	4	Z13DTC		Y9004AS	90860		
UTILITY	1.3 I	1300	1997->2000	4	13NE	0,8	BPR6EY	90310		
UTILITY	1.4 I	1400	2000->2004	4	14NE	0,8	BPR6EY	90310		
UTILITY	1.4 I	1400	2005->2006	4	Z14XE	0,8	BKR5EK	90426		
UTILITY	1.4 I	1400	2006->	4	X14SE	1,1	ZFR5F-11	93814		
UTILITY	1.4 I	1400	2006->	4	Z14XEP	1,1	ZFR5F-11	93814		
UTILITY	1.6 I	1600	1997->2004	4	16NE	0,8	BCPR6ES	96990		
UTILITY	1.7 CDTI	1700	2004->	4	Z17DTH		Y-541J	4617		
UTILITY	1.7 D	1700	2006->	4	Z17DTR		Y-541J	4617		
UTILITY	1.7 DTI	1700	2006->	4	Y17DT		Y-541J	4617		
UTILITY	1.8 I	1800	2006->	4	Z18SE	0,8	BPR6EY	90310		
VIVANT	1.6 DOHC	1600	2003->	4		1,1	BKR6E-11	94306		
VIVANT	2.0 LS DOHC	2000	2003->	4		0,8	BKR6EK	94007		

CHRYSLER

CHRYSLER

300C	2.7 LX V6	2700	2006->	6	EER	1,3	PLZTR5A-13	4998		
300C	3.0 D	3000	2005->2010	6	M664		Y8002AS	6286		
300C	3.5 LI V6	3500	2006->	6	G FI	1,3	ZFR5LP-13G	7781		
300C	3.6 I	3600	2012->	6	ERB	0,8	ILKR7B-8	1989		
300C	5.7 FI	5700	2004->	8	HEMI	1,3	PLZTR5A-13	4998		
300C	6.1 SRT8	6100	2006->	8	ESF	1,3	PLZTR5A-13	4998		
300C	6.4 392 HEMI	6400	2012->	8	V8 STR8		LZTR6AP11EG	97408		
CROSSFIRE	3.2 ROADSTER	3200	2004->	6	EGX	1	IFR6D-10	5344	BKR6E-11	94306
CROSSFIRE	3.2 SRT6 SUPERCHARGED	3200	2006->	6	EGZ	1,1	BKR5ES-11	91130		
GRAND VOYAGER	2.5 TD	2500	1995->	4	VM HR425 CLIEE		Y-741U	5065		
GRAND VOYAGER	2.5 TD	2500	2001->2003	4	VM HR425		Y-741U	5065		
GRAND VOYAGER	2.5 TD LE	2500	1995->	4	VM HR425 CLIEE		Y-741U	5065		
GRAND VOYAGER	2.8 CRD	2800	2004->2007	4	ENR		Y-1031J	96289		
GRAND VOYAGER	3.3	3301	2008->2013		EGV		LZTR5AIX-13	2314	LZTR5A-13	
GRAND VOYAGER	3.3 I	3300	2001->	6	EGA	0,8	BPR5EY	94270		
GRAND VOYAGER 5	RT 3.8	3800	2007->	6	EGL		PLZTR5A-13	4998	LZTR5AIX-13	2314
MAYBACH	5.5 57,62	5500	2002->	12	M285.590	0,8	IFR6Q-G	5648		
NEON	1.6 SE	1600	2001->	4		1,1	ZFR5F-11	93814		
NEON	2.0 LE,SE 16V	2000	1996->1998	4	ECB	0,8	BKR6E	97737		
NEON	2.0 LX , RT	2000	2000->	4	ECC/ECO	0,8	BKR6E	97737		
PT CRUISER	2.0 LTD EDITION	2000	2000->	4	EEC	1,1	LZTR4A-11	5444		
PT CRUISER	2.2 CRD	2200	2004->	4			Y-745U	4705		
PT CRUISER	2.4 EFI	2400	2003->	4	EDV	1,1	LZTR4A-11	5444		
SEBRING	2.0 FI	2000	2007->	4	VW		Y-607AS	9776		
SEBRING	2.4 I	2400	2001->	4	4G64	1,1	BKR5E-11	93674		
SEBRING	2.4 I	2400	2007->	4	EC4	1,1	LZTR4A-11	5444		
SEBRING	2.7 I	2700	2001->2002	4	EES	1,3	PTR5A-13	2467	TR5B-13	97667
SEBRING	2.7 LX V6	2700	2009->	6	DFI	1,3	PLZTR5A-13	4998		
SEBRING	3.5 V6	3500	2009->	6	EGF	1,3	ZFR5LP-13G	7781		
VALIANT	3.7 ALL MODELS	3700	1972->1978	6		0,8	BPR5ES	94084		
VOYAGER	2.4 16V	2400	2003->	4	EDZ	1,1	LZTR4A-11	5444		
VOYAGER	2.5 CRD	2500	1995->2001	4	VM		Y-741U	5065		
VOYAGER	2.8 CRDI	2800	2010->	4	ENS		Y8011AS	90403		
VOYAGER	3.3 I	3300	2001->	6	EGM	1,3	LZTR5AIX-13	2314	LZTR6AIX-13	2315
VOYAGER 1	2.5 SE	2500	1988->	6	EDM	0,8	BPR6ES	96989		
VOYAGER 1	3.0 I	3000	1988->	6	EFA	1,1	BPR5ES-11	4424		
VOYAGER 2	2.0 I	2000	1997->2001	4	ECB	0,8	BKR6E	97737		
VOYAGER 2	2.4 I	2400	1996->	4	EDZ	1,1	ZFR5A-11	5084		
VOYAGER 2	2.5 I	2500	1992->	6	EDM	0,8	BPR6ES	96989		
VOYAGER 2	3.3 I	3300	1994->1996	6	EGA	0,8	BPR5EY	94270		
VOYAGER 2	3.3 I	3300	1996->2001	6	EGA V6 MPI	0,8	GR4IX	7149	BPR4ES	7222
VOYAGER 3	2.4 SE	2400	2000->	4	EDZ	1,1	BKR5ES-11	91130		
VOYAGER 3	3.3 SE	3300	1997->	6	EGA	0,8	BPR5EY	94270		
VOYAGER 3	3.3 SE	3300	2001->	6	EGA	1,3	LZTR5AIX-13	2314	LZTR6AIX-13	2315
VOYAGER 4	2.5 CRD	2500	2000->2007	4	ENC		Y-1031J	96289		
VOYAGER 4	2.5 CRD	2500	2005->2007	4	EDK/ ENJ		Y-1031J	96289		
VOYAGER 4	2.8 CRD	2800	2004->2008	4	ENR		Y-1031J	96289		
VOYAGER 5	RG,RS 3.3	3300	2000->2008	6	EGA		PLZTR5A-13	4998	LZTR5AIX-13	2314

BERLINGO	1.4 HDI	1400	2005->	4	DV4TD		YE04	1101		
----------	---------	------	--------	---	-------	--	------	------	--	--



CAR • SUV • LCV



Model	Type	Capacity	Year	Cyl	Engine	Gap	Recommended	Stock Code	Alternative	Stock Code
CITROEN										
BERLINGO	1.4 I	1400	2002->	4	TU3JP	0,8	BKR6EZ	4619		
BERLINGO	1.4 MULTISPACE	1400	2004->	4	TU3JP	0,8	BKR6EK	94007		
BERLINGO	1.6 95 VTI	1600	2010->	4	EP6CDTR	0,8	PLZKBR7B8G			
BERLINGO	1.6 HDI	1600	2009->	4	DV6AUTED4		YE05	5207		
BERLINGO	1.6 I 16V	1600	2001->	4	TU5JP4	0,9	LF6B	6677		
BERLINGO	1.9 D	1900	1998->2003	4	XUD9A		Y-924J	3473		
BERLINGO	1.9 MULTISPACE	1900	1998->2002	4	DW8 WJZ		Y-503J	5005		
BX17	1.8 TD, TRD	1800	1988->1993	4	XUD 7 TE		Y-924J	3473		
BX19	1.9 D RD, TD, TRD	1900	1983->1987	4	XUD 9		Y-924J	3473		
C1	1.0 FURIO,IPLAY	1000	2006->2011	3	384F	1,1	LF6C-11	96098	ILFR6T-11	4904
C1	1.2 I	1200	2014->	3	EB2D	1	LZKR6AI-10G	97999		
C1	1.2 VTI	1200	2012->2013	3	EB2	1	LZKR6AI-10G	97999		
C15	1.8 D	1800	1984->1995	4	XUD7		Y-924J	3473		
C2	1.4 HDI	1400	2005->	4	DV4TD		YE05	5207		
C2	1.4 VTR	1400	2004->	4	TU3JP-KFV	0,8	BKR6EZ	4619		
C2	1.6 VTS 16V	1600	2005->	4	TU5JP4 NFU	0,9	LF6B	6677		
C25	1.9 D	1900	1987->1994	4	D9B		Y-924J	3473		
C25	2.5 TD	2500	1987->1994	4	CRD93LS		Y-208T	1250		
C3	1.0 VTI 68	1000	2012->	3	EB0	1	LZKR6AI-10G	97999		
C3	1.2 VTI 82	1200	2012->	3	EB2	1	LZKR6AI-10G	97999		
C3	1.4 95 VTI	1400	2008->	4	EP3	0,8	PLZKBR7B8G			
C3	1.4 HDI, X-TR 16V	1400	2003->	4	DV4ETD4		YE04	1101		
C3	1.4 VTI	1400	2002->	4	TU3JP-KFX,KFV	0,8	BKR6EZ	4619		
C3	1.4 VTI	1400	2003->	4	ET3J4-KFU	0,8	LZKAR7A	6799		
C3	1.6 120 VTI	1600	2009->	4	EP6C	0,8	PLZKBR7B8G			
C3	1.6 16V	1600	2002->	4	TU5JP4 NFU	0,9	LF6B	6677		
C3	1.6 D	1600	2005->	4	DV6TED4		YE05	5207		
C3	1.6 HDI	1600	2006->	4	DV4TED6		YE05	5207		
C3	1.6 HDI	1600	2009->	4	DV6CTED4		Y8001AS	8851		
C3	1.6 VTI	1600	2002->	4	TU5JP	0,9	LF6B	6677		
C3	1.6 VTI COMFORT	1600	2008->	4	EP6	0,8	PLZKBR7B8G			
C4	1.6 16V	1600	2005->	4	TU5JP4 NFU	0,9	LF6B	6677		
C4	1.6 HDI	1600	2004->2006	4	DV6TED4		YE04	1101		
C4	1.6 HDI	1600	2007->	4	DV6TED		YE05	5207		
C4	1.6 THP	1600	2010->	4	EP6CDT	0,8	PLZKBR7B8G			
C4	1.6 VTI	1600	2010->	4	EP6C	0,8	PLZKBR7B8G			
C4	2.0 16V	2000	2005->	4	EW10A	0,8	LF6B	7113		
C4	2.0 HDI	2000	2008->	4	DW10BTED4		Y-1005J	8939		
C4	2.0 TD	2000	2004->	4	DW10BTED4		Y-504J	6246		
C4	2.0 VTS	2000	2004->	4	EW10A	0,8	LF6B	6677		
C4	C4 CACTUS (THP110)	1199	2016->	3	EB2DT HNZ		LZKR6AI-10G	97999		
C4 AIRCROSS	1.6 AIRCROSS	1600	2012->	4	4A92	1,1	DILFR5A-11D	98376		
C4 AIRCROSS	1.6 HDI AIRCROSS	1600	2012->	4	DV6C		Y8001AS	8851		
C4 AIRCROSS	1.6 I	1600	2012->	4	4A92	1,1	DILFR5A-11D	98376		
C4 AIRCROSS	2.0 I	2000	2012->	4	4A92	1,1	DILFR5A-11D	98376		
C4 CACTUS	1.2 I	1200	2015->	4	EB2DT	1	LZKR6AI-10G	97999		
C5	1.6 HDI	1600	2012->	4	DV6C		Y8001AS	8851		
C5	1.6 THP	1600	2009->	4	EP6CDT	0,8	PLZKBR7B8G			
C5	2.0 16V	2000	2001->	4	EW10J4 RFN	0,9	LF6B	7113		
C5	2.0 HDI	2000	2001->	4	DW10ATED		Y-504J	6246		
C5	2.0 HDI	2000	2002->	4	DW10ATD		Y-504J	6246		
C5	2.0 HDI	2000	2004->	4	DW10BTED4		Y-1005J	8939		
C5	2.2 HDI 16V	2200	2001->	4	DW12TED4		Y-504J	6246		
C5	3.0 V6	3000	2001->	6	ES9J4 XFX	1,1	PLFR5A-11	6240	LF6B-11	95304
C6	3.0 V6 24V	3000	2005->	6	XVF	1,1	ILZFR6D-11	6087		
C8	2.0 HDI 16V	2000	2002->	4	DW10TED4/RHT		Y-504J	6246		
C8	2.0 LX	2000	2002->	4	EW10J4-RFN	0,9	LF6B	7113		
C8	2.2 HDI 16V	2200	2002->	4	DW12TED4/4HW		Y-504J	6246		
C8	2.2 LI	2200	2002->	4	EW12J4-352	0,9	LF6B	7113		
DISPATCH	2.0 TD	2000	2000->	4	DW10		Y-504J	6246		
DS 20	2.0 GL	2000	1972->1975	4		0,8	BP7HS	5111		
DS 21	2.2 GL	2200	1972->1975	4		0,8	B6HS	4510	BR6HS	3922
DS 23	2.3 GL	2300	1972->1975	4		0,8	BP7HS	5111		
DS3	1.2 VTI 82	1200	2011->	3	EB2	1	LZKR6AI-10G	97999		
DS3	1.4 I	1400	2010->	4	EP3C	0,8	PLZKBR7B8G			
DS3	1.6 HDI 90	1600	2009->	4	DV6C		Y8001AS	8851		
DS3	1.6 THP	1600	2010->	4	EP6DT/EP6CDT	0,8	PLZKBR7B8G			
DS3	1.6 VTI	1600	2010->	4	EP6C	0,8	PLZKBR7B8G			
DS4	1.6 120 VTI	1600	2011->	4	EP6C	0,8	PLZKBR7B8G			
DS4	1.6 155 THP	1600	2011->	4	EP6DT / EP6CDT	0,8	PLZKBR7B8G			
DS4	1.6 200 THP	1600	2011->	4	EP6CDTX	0,8	ILZKBR7B8G			



CAR • SUV • LCV



Model	Type	Capacity	Year	Cyl	Engine	Gap	Recommended	Stock Code	Alternative	Stock Code
-------	------	----------	------	-----	--------	-----	-------------	------------	-------------	------------

CITROEN

CITROEN

DS4	1.6 E-HDI	1600	2011->	4	DV6C		Y8001AS	8851		
DS4	1.6 HDI 110	1600	2011->	4	DV6C		Y8001AS	8851		
DS4	2.0 HDI 160	2000	2011->	4	DW10CTED4		Y8001AS	8851		
DS5	1.6 155 THP	1600	2011->	4	EP6CDT	0,8	PLZKBR7B8G			
DS5	1.6 200 THP	1600	2011->	4	EP6CDTX	0,8	PLZKBR7B8G			
DS5	2.0 HDI	2000	2011->	4	DW10CTED4		Y8001AS	8851		
PICASSO	1.6 16V	1600	2001->	4	TU5JP4 NFU	0,9	LFR6B	6677		
PICASSO	1.6 8V	1600	2000->	4	TU5JP NFZ					
PICASSO	1.6 120 VTI	1600	2009->	4	EP6	0,8	PLZKBR7B8G			
PICASSO	1.6 E-HDI 115	1600	2013->	4	DV6C		Y8001AS	8851		
PICASSO	1.6 THP 155	1600	2013->	4	EP6CDT	0,8	PLZKBR7B8G			
PICASSO	1.8 16V	1800	2001->	4	EW7J4 6FZ	0,9	LFR5B	7113		
PICASSO	2.0 16V	2000	2003->	4	EW10J4 RFM	0,9	LFR5B	7113		
PICASSO	2.0 BLUEHDI 150	2000	2013->	4	DW10FD		Y8001AS	8851		
PICASSO	2.0 HDI	2000	2003->	4	DW10TD		Y-504J	6246		
RELAY	1.9 TD	1900	1998->	4	XUD9TF		Y-924J	3473		
RELAY	2.0 TD	2000	1998->	4	DW10TD/DU		Y-504J	6246		
XSARA	1.6 8V	1600	1997->2000	4	TU5JP NFZ	0,8	BKR6EZ	4619		
XSARA	1.8 16V	1800	2000->	4	EW7 J4 6FZ	0,9	LFR5B	7113		
XSARA	2.0 16V	2000	2000->	4	XU10J4RS	0,8	BKR6EK	94007		
XSARA	2.0 HDI	2000	2002->	4	DW10D RHZ/RHY		Y-504J	6246		
XSARA	2.0 VTS 16V	2000	2001->	4	EW10J4 RFM	0,9	LFR5B	7113		

DACIA

DACIA

CRISTAL FWD	1.6 S/WAGON	1600	1995->	4		0,6	BP6HS	4511	BPR6HS	7022
ELAN RWD	1.6 1TON PICKUP	1600	1995->	4		0,6	BP6HS	4511	BPR6HS	7022
MAGIC RWD	1.6 DOUBLE CAB	1600	1995->	4		0,6	BP6HS	4511	BPR6HS	7022

DAEWOO

DAEWOO

CIELO	1.5 16V GLX	1500	1996->1998	4	A15MF DOHC	1,1	BKR6E-11	94306		
CIELO	1.5 GTX	1500	1997->1998	4	DOHC	1,1	BKR6E-11	94306		
CIELO	1.5 IL	1500	1996->1998	4	SOHC	1,1	BPR6ES-11	94967		
CIELO	1.5 LX	1500	1996->1998	4	G15MF SOHC	0,8	BPR6ES	96989		
ESPERO	1.8 CD 8V	1800	1996->1998	4	C18LE SOHC	0,8	BPR6ES	96989		
ESPERO	2.0 CD 8V	2000	1996->1998	4	C20LE SOHC	0,8	BPR6ES	96989		
LANOS	1.3 I	1300	1998->2001	4	SOHC	0,8	BPR6ES	96989		
LANOS	1.4 I	1400	2000->2003	4	A14SMS,SOHC	0,8	BPR6ES	96989		
LANOS	1.6 I 16V	1600	1997->2000	4	E-TEC, A16DMS	0,8	BKR6E	97737		
LEGANZA	2.0 I	2000	1997->2002	4	X20SED	0,8	BKR5EK	90426		
MATIZ	0.8 S,SE	800	1999->2003	3	F8CV	1,1	BPR5EY-11	95989		
MATIZ	1.0 SI	1000	2003->	4	B10S	1,1	BPR5EY-11	95989		
NUBIRA	1.6 SX 16V	1600	1997->2000	4	A16DMS E-TEC	1,1	BKR6E-11	94306		
NUBIRA	1.8 CDX	1800	2003->2005	4	T18SED	0,8	BKR5EK	90426		
NUBIRA	2.0 CDX 16V	2000	1997->2003	4	X20SED E-TEC	0,8	BKR5EK	90426		
TACUMA	1.6 SX 16V	1600	2001->2003	4	E-TEC	0,8	BKR6E	97737		
TACUMA	2.0 CDX 16V	2000	2001->2003	4	DOHC	0,8	BKR6E	97737		

DAIHATSU

DAIHATSU

CHARADE	1.0 C	1000	2003->	3	EJ-VE	0,8	BKR5EK	90426		
CHARADE	1.0 CX,CXL	1000	1983->1985	3	GB22	0,8	BPR5ES	94084		
CHARADE	1.0 CX,CXL	1000	2003->	3		0,8	BPR6EY	90310		
CHARADE	1.0 TURBO	1000	1984->1985	3	GB60	0,8	BPR6ES	96989		
COPEN	1.3 L	1300	2006->	4	K3-	1,1	IFR6T-11	4589	BKR6EYA-11	91206
CUORE	0.8 I	800	1997->1999	3	ED10	0,8	BPR6ES	96989		
CUORE	1.0 I	1000	1998->2003	3	EJ-DE	1,1	BKR5E-11	93674		
FEROZA	1.6 I	1600	1998->1999	4	HD-E	1,1	BKR6E-11	94306		
GRAN MAX	1.5 I	1500	2013->	4	3S-VE	0,9	DCPR7EA-9	6651		
GRAN MOVE	1.5 FI	1500	1998->2001	4	HE-EG	1,1	BKR6E-11	94306		
GRAN MOVE	1.5 I	1500	1997->	4	HE-EG	1,1	BKR6E-11	94306		
GRAN MOVE	1.6 I	1600	1999->	4	HD-EP	1,1	BKR6E-11	94306		
MATERIA	1.3 FI	1300	2007->	4	K3-VE	0,8	IKR7D	4759	DCPR7EA-9	6651
MATERIA	1.5 FI	1500	2006->2007	4	3SZ-VE	0,8	IKR7D	4759	DCPR7EA-9	6651
MOVE	0.66 I	660	2007->	3	KF-VE	0,7	LKR7E	1643		
MOVE	0.8 I	800	1997->2000	3	ED20	1,1	BPR5EY-11	95989		
ROCKY	2.0 I	2000	1997->	4	F80V	0,8	BP5EY	96534	BPR5EY	94270
ROCKY	2.8	2800	1987->1993	4	DL51		Y-146R	7492		
SIRION	1.0 I	1000	1999->2001	4	EJ-DE	0,8	BKR6EK	2213		
SIRION	1.0 I	1000	2005->	3	1KR-FE	1,1	LFR6C-11	96098	ILFR6T-11	4904
SIRION	1.3 I	1300	2000->2004	4	K3-VE 2	1	BKUR6ETB	6992		



CAR • SUV • LCV



Model	Type	Capacity	Year	Cyl	Engine	Gap	Recommended	Stock Code	Alternative	Stock Code
DAIHATSU										
SIRION	1.3 I	1300	2005->	4	K3-VE	1,1	BKR6EY-11	93888		
SIRION	1.3 I	1300	2008->	4	K3-VE	0,9	DCPR7EA-9	6651		
SIRION	1.5 I	1500	2007->	4	3S-ZVE	0,9	DCPR7EA-9	6651		
TERIOS	1.3 I	1300	1997->2000	4	HC-EJ	0,8	BKUR6EK	2213		
TERIOS	1.3 I	1300	2000->2005	4	K3-VE	1	BKUR6ETB	6992		
TERIOS	1.3 I	1300	2008->	4	K3-VE	1,1	BKR6EY-11	93888		
TERIOS	1.5 I	1500	2006->2007	4	3SZ-VE	0,8	IKR7D	4759	DCPR7EA-9	6651
YRV	1.1 I	1100	2001->	3	EJ-VE	1,1	BKR5E-11	93674		
YRV	1.3 FI	1300	2001->	4	K3-VE	1,1	IFR6T-11	4589	BKR6EYA-11	91206
YRV	1.3 TURBO	1300	2002->	4	K3-VET	1,1	PFR6G-11	5555	BKR6E-11	94306
DAIMLER										
3.6	3.6 LX	3600	1987->1991	6	AJ6	0,8	BCPR6ES	96990	BCP6ES	94000
4.0	4.0 SX	4000	1990->1998	6	AJ6	0,8	BCPR6ES	96990	BCP6ES	94000
DOUBLE SIX	5.3 L	5300	1982->1985	12	HE	0,8	BPR6EFS	92170		
DATSUN										
GO	1.2 I	1200	2014->	3	HR12DE 13	1,1	LZKAR6C-11	96343		
DODGE										
CALIBER	1.8 FI	1800	2006->	4	CFI	1,1	ZFR5F-11	93814		
CALIBER	2.0 CRD	2000	2006->	4	ECD, ECE		YE 14	5661		
CALIBER	2.0 SX	2000	2006->	4	BFI	1,1	ZFR5F-11	93814		
CALIBER	2.4 RT	2400	2006->	4	KFI	1,1	ZFR5F-11	93814		
CHARGER	2.7 SE V6	2700	2009->	6	DFI	1,3	LZTR5AIX-13	2314		
CHARGER	3.5 SE V6	3500	2009->	6	VFI	1,3	ZFR5LP-13G	7781		
CHARGER	5.7 RT V8	5700	2009->	8	TFI	1,1	LZFR5C-11	92633		
CHARGER	6.1 SRT8 V8	6100	2006->	8	WFI	1,3	LZTR5AIX-13	2314		
JOURNEY	2.4 I	2400	2011->	4	3D4G	1,1	ZFR5F-11	93814		
JOURNEY	3.6 V6	3600	2012->	6	ERB	0,8	ILKR7B-8	1989		
MAGNUM	6.1 SRT8 FI	6100	2006->	8	WFI	1,3	LZTR5AIX-13	2314		
NITRO	3.7 V6	3700	2008->	6	KFI	1,1	ZFR6F-11G	3869		
NITRO	4.0 V6	4000	2008->	6	RT FI	1,3	ZFR5LP-13G	7781		
STEALTH	3.0 V6	3000	2003->	6	6G72	1,1	BPR5ES-11	4424		
VIPER	8.4 SRT 10	8400	2009->	10	V10	1,3	LZTR5AIX-13	2314	LZTR7AIX-13	5107
FAW										
SIRIUS	1.3	1300	2012->	4	K3VE	0,8	DCPR7E	3932		
SIRIUS	1.5 I	1500	2012->	4	K5VE	0,8	DCPR7E	3932		
V2	1.4 I	1400	2012->	4		1,1	BKR5EP-11	3440	BKR5E-11	93674
FERRARI										
360	3.6 SPIDER	3600	2003->	8	F131B	0,7	PMR8B	6378	CPR8EA-9	2306
599	6.0 GTB	6000	2007->	12	F140C	0,7	PMR8B	6378	CPR8EA-9	2306
612	5.7 SCAGLIETTI	5700	2004->	12	F133F	0,7	DCPR9EIX	2316	DCPR9E	2641
CHALLENGE STRADALE	3.6 I	3600	2004->	8	F131B	0,7	PMR8B	6378	CPR8EA-9	2306
F308	3.0 GTB, GTS	3000	1981->1985	8	F106B	0,8	BPR8EIX	6684	BPR8ES	3923
F355	3.5 I	3500	1998->	8	BERLINETTA	0,7	PMR7A	4259	CPR7EA-9	3901
F430	4.3 COUPE, CHALLENGE, SPIDER	4300	2007->	8	F136E	0,7	PMR8B	6378	CPR8EA-9	2306
F430	4.3 SCUDERIA	4300	2008->	8	F136ED	0,7	PMR8B	6378	CPR8EA-9	2306
F50	4.7 I	4700	1995->	12	F130B	0,7	PMR7A	4259	CPR7EA-9	3901
MONDIAL	3.4 TURBO	3400	1988->1994	8	F119DL	0,8	DR8EIX	6681	DR8EA	7162
TESTAROSSA	4.9 L	4900	1984->1991	12	F113B000	0,8	DR8EIX	6681	DR8EA	7162
FIAT										
128	1.3 L	1300	1974->1984	4	128A.1000	0,8	BPR6ES	96989		
131	1.3 CARB	1300	1980->1984	4	131A	0,8	BPR6ES	96989		
131	2.0 LX	2000	1981->1984	4	131C4	0,8	BPR6ES	96989		
500	1.2 I	1200	2007->	4	169A.4000	1	ZKR7A-10	1691		
500	1.4 I	1400	2007->	4	169A.3000	1	DCPR7E-N-10	4983		
500	1.4 I	1400	2008->	4	198A.1000	0,8	IKR9J8	93311		
500C	0.9 T TWINAIR	900	2012->	2	312.A4000	1,2	LKR7DI-12	90779		
500L	0.9 I	900	2012->	2	199B.6000	0,8	ILKR9G8	97168		
500L	1.4 I	1400	2012->	4	843A.1000	0,8	DCPR7E-N	4795		
500L	1.6 MULTIJET	1600	2012->	4	199B.4000		Y-9001AS	93707		
500X	1.4I CROSS	1400	2015->	4	55263623	0,8	IKR9J8	93311		



CAR • SUV • LCV



Model	Type	Capacity	Year	Cyl	Engine	Gap	Recommended	Stock Code	Alternative	Stock Code
FIAT										
500X	1.6I POP STAR	1600	2015->	4	55263623	0,8	IKR9J8	93311		FIAT
BRAVO	1.2 12V	1400	1998->2001	4	182A.3000	0,7	BKR6EK	94007		
BRAVO	1.2 I	1200	1999->2001	4	182B.2000	0,8	DCPR8E	4339		
BRAVO	1.4 16V TURBO	1400	2007->	4	198A.1000	0,8	IKR9J8	93311		
BRAVO	1.6 FI	1600	1999->2001	4	182A.4000	0,8	BKR5EZ	7642		
BRAVO	1.8 I	1800	1995->2001	4	182A.2000	0,7	BKR6EK	94007		
BRAVO	1.9 D	1900	2007->	4	192A.8000		Y-1030J	90002		
BRAVO	1.9 D	1900	2007->2008	4	192B.5000		Y-1030J	90002		
BRAVO	1.9 JTD	1900	2007->2014	4	937.A5000		YE07	6092		
BRAVO	2.0 FI	2000	1999->2001	4	182A.1000	0,7	BKR6EK	94007		
CROMA	2.2 I	2200	2005->	4	194A.1000	1	LTR6B-10T	5948		
DOBLO	1.2 8V	1200	2005->	4	223A.5000	1	DCPR7E-N-10	4983		
DOBLO	1.2 P/VAN	1200	2000->2004	4	223A.5000	0,8	BKR5EZ	7642		
DOBLO	1.2 P/VAN	1200	2004->2005	4	223A.5000	1	DCPR7E-N-10	4983		
DOBLO	1.3 MULTIJET	1300	2010->	4	199A3000/263A2000		Y-8003J	90784		
DOBLO	1.4 CARGO	1400	2010->	4	843A1.000	1	DCPR7E-N-10	4983		
DOBLO	1.4 P/VAN	1400	2005->	4	350A.1000	1	ZKR7A-10	1691		
DOBLO	1.6 D MJET	1600	2010->	4	263A.4000		Y-9003AS	95836		
DOBLO	1.6 MULTIJET	1600	2010->	4	198A.3000		Y-9003AS	95836		
DOBLO	1.6 P/VAN	1600	2000->2005	4	182B.6000	0,8	BKR5EZ	7642		
DOBLO	1.9 D	1900	2000->2004	4	223A.6000		Y-939J	5979		
DOBLO	1.9 D	1900	2001->2003	4	182B.9000		Y-534J	5540		
DOBLO	1.9 MJT 105CV	1900	2003->2005	4	223A.7000		Y-534J	5540		
DOBLO	1.9 TD	1900	2003->	4	223A.6000		Y-939J	5979		
DOBLO	1.9 TD	1900	2004->	4	182B.9000		Y-534J	5540		
DUCATO	2.3 MULTIJET	2300	2002->	4	F1AE0481C		Y-8005J	94629		
FIORINO	1.3 TDI	1300	2005->2013	4	199A2000		Y-9001AS	93707		
FIORINO	1.3 TDI	1300	2007->	4	199A2000		Y-8003J	90784		
FIORINO	1.4 I	1400	1993->	4	160.A1.046	0,8	BPR5ES	94084		
GRANDE PUNTO	1.2 I	1200	2006->	4	199A.4000	1	ZKR7A-10	1691		
GRANDE PUNTO	1.3 TD	1300	2006->	4	188A.9000		Y-8003J	90784		
GRANDE PUNTO	1.4 16V	1400	2006->	4	199A.6000	1	ZKR7A-10	1691		
GRANDE PUNTO	1.4 16V	1400	2007->	4	198A.4000	0,8	IKR9J8	93311		
GRANDE PUNTO	1.4 EL	1400	2005->	4	350A.1000	1	ZKR7A-10	1691		
GRANDE PUNTO	1.9 D	1900	2006->	4	188A7000		Y-534J	5540		
IDEA	1.2 16V	1200	2005->	4	188A.5000	1	DCPR7E-N-10	4983		
IDEA	1.4 16V	1400	2003->2005	4	843A.1000	1	DCPR7E-N-10	4983		
IDEA	1.4 16V	1400	2005->	4	843A.1000	1	DCPR7E-N-10	4983		
LINEA	1.4 I	1400	2007->	4	350A.1000	1	ZKR7A-10	1691		
MULTIPLA	1.6 16V	1600	2002->	4	186A.4000	0,8	BKR6E	97737		
MULTIPLA	1.9 JTD	1900	2003->	4	186A.8000		Y-534J	5540		
PALIO	1.2	1200	1997->2005	4	178B.7045		DCPR7E-N-10	4983		
PALIO	1.2 16V	1200	2002->	4	188A.5000	1	DCPR7E-N-10	4983		
PALIO	1.2 8V WEEKEND	1200	1997->2000	4	178B.5000	0,8	BKR6E	97737		
PALIO	1.4 L	1400	1997->	4	178B.2000	0,8	BKR5EZ	7642		
PALIO	1.6 16V	1600	1997->1999	4	178B.3000	0,8	BKR6E	97737		
PALIO 2	1.2 8V	1200	2005->	4	176A.8000	0,8	BKR6E	97737		
PALIO 2	1.7 TD 8V	1700	2005->	4	176A.3000		Y-924J	3473		
PANDA	0.9 T TWINAIR	900	2012->	2	312.A2000	0,8	ILKR9G8	97168		
PANDA	1.1 I	1100	2005->	4	187A.1000	1	DCPR7E-N-10	4983		
PANDA	1.2 EL	1200	2006->	4	169A.4000	1	ZKR7A-10	1691		
PANDA	1.2 I	1200	2012->	4	169A.4000	1	ZKR7A-10	1691		
PANDA	1.2 L	1200	2004->	4	188A.4000	0,8	BKR5EZ	7642		
PANDA	1.3 D	1300	1986->1989	4	156A.5000		Y-924J	3473		
PANDA	1.4 100 HP	1400	2007->	4	169A.3000	1	DCPR7E-N-10	4983		
PUNTO	0.9 I	900	2012->	2	312A.2000	0,8	ILKR9G8	97168		
PUNTO	1.2 16V	1200	2004->	4	188A.5000	1	DCPR7E-N-10	4983		
PUNTO	1.2 EVO	1200	2010->2012	4	199A.4000	1	ZKR7A-10	1691		
PUNTO	1.2 I	1200	2012->	4	169A.4000	1	ZKR7A-10	1691		
PUNTO	1.3 JTD	1300	2004->	4	188A.9000		Y-8003J	90784		
PUNTO	1.4 16V EVO MULTI AIR	1400	2010->2012	4	955A.6000	1	DCPR7E-N-10	4983		
PUNTO	1.4 EVO	1400	2010->2012	4	350A.1000	1	ZKR7A-10	1691		
PUNTO	1.4 I	1200	2012->	4	350A.1000	1	ZKR7A-10	1691		
PUNTO	1.4 I	1400	2012->	4	199A.7000	1	ZKR7A-10	1691		
PUNTO	1.4 I MULTI AIR	1400	2012->	4	955A.6000	1	DCPR7E-N-10	4983		
PUNTO	1.4 L	1400	1993->1999	4	176A.4000	0,8	BCPR6ET	2197		
PUNTO	1.4 L 16V	1400	2003->	4	843A.1000	1	DCPR7E-N-10	4983		
PUNTO	1.4 TURBO MULTI AIR	1400	2012->	4	955A.2000	0,8	IKR9J8	93311		
PUNTO	1.6 EVO	1600	2009->2012	4	955A.3000		Y-9003AS	95836		
PUNTO	1.8 HGT	1800	2002->	4	183A.1000	0,8	BKR6EK	94007		
QUBO	1.3 D MJET EURO 4	1300	2008->	4	199A.2000		Y-9001AS	93707		
QUBO	1.3 MULTIJET EURO 5	1300	2008->	4	199A.2000		Y-8003J	90784		



CAR • SUV • LCV



Model	Type	Capacity	Year	Cyl	Engine	Gap	Recommended	Stock Code	Alternative	Stock Code
FIAT										
QUBO	1.4 I	1400	2009->	4	350A.1000	1	ZKR7A-10	1691		FIAT
SCUDO	2.0 L	2000	2000->	4	RHX JTD		Y-504J	6246		
SEICENTO	1.1 I	1100	2001->	4	176B.2000	0,8	BKR6EY	91756		
SEICENTO	1.1 I	1100	2004->	4	187A.1000	1	DCPR7E-N-10	4983		
SIENA	1.2 EL	1200	1999->	4	178B.5000	0,8	BKR6E	97737		
SIENA	1.6 EL	1600	1999->	4	178B.3000	0,8	BKR6E	97737		
SIENA 2	1.2 EL	1200	2005->	4	176A.8000	0,8	BKR6E	97737		
SIENA 2	1.7 TD	1700	2005->	4	176A.3000		Y-924J	3473		
SPIDER	2.0 I	2000	1996->	4		0,8	BPR7ES	95164		
STILO	1.4 16V	1400	2004->2005	4	843A.1000	0,8	DCPR7E-N	4795		
STILO	1.6 ACTIVE_ACTUAL	1600	2004->	4	182B.6000	0,8	BKR5EZ	7642		
STILO	1.9 JTD 115 CV	1900	2001->2005	4	192A.1000		Y-534J	5540		
STILO	1.9 JTD 80 CV	1900	2001->2004	4	192A.3000		Y-534J	5540		
STILO	2.4 20V	2400	2004->	5	192A.2000	0,8	BKR6EZ	4619		
STRADA	1.2 I	1200	1999->2003	4	188A.4000	0,8	BKR5EZ	7642		
STRADA	1.2 I	1200	2004->	4	178B.7045	1	DCPR7E-N-10	4983		
STRADA	1.4 16V	1400	2007->	4	843.A.1000	0,8	DCPR7E-N	4795		
STRADA	1.6 I	1600	1999->2004	4	178D.2011	0,8	BKR5EZ	7642		
STRADA	1.7 TD	1700	2005->	4	176A.3000		Y-924J	3473		
TIPO	1.3 D MULTIJET	1300	2016->	4	55266963		Y-9001AS	93707		
TIPO	1.4 I	1400	2016->	4	843.A1000	1	DCPR7E-N-10	4983		
ULYSSE	1.9 D	1900	2000->	4	XUD9TFL		Y-924J	3473		
ULYSSE	2.0 SX	2000	1999->	4	RFU(XU10J2C,L3)	0,8	BKR6E	97737		
UNO	1.0 CENTO	1000	1996->1998	4	160A3	0,8	BKR5ES	90841		
UNO	1.1 ESPRESSO	1100	1992->	4	160A3	0,8	BKR5ES	90841		
UNO	1.1 FIRE	1100	1991->	4	160A3	0,8	BKR5ES	90841		
UNO	1.1 MIA	1100	1998->	4	160A3	0,8	BKR5ES	90841		
UNO	1.1 RIO	1100	1995->	4	160A3	0,8	BKR5ES	90841		
UNO	1.1TEMPO	1100	1998->	4	160A1	0,8	BKR5ES	90841		
UNO	1.2 FIRE	1200	2007->	4	158.376.6	0,8	BKR6E	97737		
UNO	1.4 BEAT	1400	1994->	4	146C1	0,8	BPR6ES	96989		
UNO	1.4 MIA	1400	1998->2000	4		0,8	BPR6ES	96989		
UNO	1.4 PACER CARB	1400	1990->2000	4	160A1	0,8	BPR6ES	96989		
UNO	1.4 TEMPO	1400	1998->2000	4		0,8	BPR6ES	96989		
UNO	1.4 TURBO	1400	1990->1998	4	146A8.046	0,8	BCPR6ET	2197		
X1/9	1.3 S	1300	1973->1979	4	128AS.000	0,8	BPR6ES	96989		
X1/9	1.5 S	1500	1978->1989	4		0,8	BPR6ES	96989		

FORD										
3000	3.0 1TONNER	3000	1997->	6	ESSEX	0,8	BPR6ES	96989		
B-MAX	1.0 ECOSPORT	1000	2015->	3	M1JE	0,7	SILZNAR8C-7H	93593	ILNAR8B7G	91970
B-MAX	1.0 ECOSPORT	1000	2015->	3	SFJA/SFJB	0,7	SILZNAR8C-7H	93593	ILNAR8B7G	91970
BANTAM	1.3 I	1300	2003->	4	ROCAM	1	TR5B-13	97667		
BANTAM	1.3 PICK-UP	1300	1983->1986	4	KENT	0,8	BPR6ES	96989		
BANTAM	1.4 L	1400	1986->1994	4	CVH	0,8	BCP6ES	94000	BCPR6ES	96990
BANTAM	1.6 I	1600	1994->	4	B6	0,8	BPR6ES	96989		
BANTAM	1.6 I	1600	2003->	4	ROCAM	1	TR6B-10	94480		
BANTAM	1.6 L	1600	1984->1994	4	CVH	0,8	BCP6ES	94000	BCPR6ES	96990
BANTAM	1.8 D	1800	2002->	4	YD18TCI		Y-524J	5986		
BANTAM	1.8 D	1800	2002->	4			Y-937J	4118		
CORTINA	1.3 L	1300	1963->	4	KENT	0,8	BPR6ES	96989		
CORTINA	1.6 1TONNER	1600	1977->1986	4	KENT	0,8	BPR6ES	96989		
CORTINA	1.6 GL,L	1600	1977->1983	4	KENT	0,8	BPR6ES	96989		
CORTINA	2.0 GHIA, GL, GLE	2000	1983->	4	KOLN	0,8	AP6FS	2710	APR6FS	2922
CORTINA	2.0 RS (MODIFIED)	2000	1978->1980	4	KOLN	0,8	AP8FS	2227		
CORTINA	3.0 1TONNER	3000	1977->1986	6	ESSEX	0,8	BPR7ES	95164		
CORTINA	3.0 XR-6, GHIA, GL, S, GLS	3000	1977->1983	6	ESSEX	0,8	BPR6ES	96989		
COURIER	1.6 L	1600	1986->1991	4	F6	0,8	BPR5ES	94084		
COURIER	1.8 H	1800	1991->2000	4	F8	0,8	BPR6ES	96989		
COURIER	2.0 LWB	2000	1986->1991	4	FE	0,8	BPR5ES	94084		
COURIER	2.2 D	2200	1986->1997	4	R2		Y-107-R	1229		
COURIER	2.2 LE	2200	1991->2000	4	F2	0,8	BKR6E	97737		
COURIER	2.5 TD	2500	1997->2000	4	WL		Y-701J	5116		
COURIER	3.0 TDCI	3000	2008->	4	WEAT		Y-526J1	92657		
COURIER	3.0 V6	3000	1986->1996	6	ESSEX	0,8	BPR7ES	95164		
COURIER	3.4 V6	3400	1997->2000	6	ESSEX	1,1	BPR7ES-11	7226		
ECONOVAN	2.0 G	2000	1985->	4	RF		Y-107-R	1229		
ECOSPORT	1.0 T	1000	2014->	3	M1JC	0,7	SILZNAR8C-7H	93593	ILNAR8B7G	91970
ECOSPORT	1.5 T	1500	2014->	4	14MY DURATEC	0,8	ILTR6H-8G	96870	ILTR6A-13G	
ECOSPORT	1.5 TDCI	1500	2014->	4			Y8001AS	8851		
ECOSPORT	1.6 TI	1600	2011->	4	HXJD	0,8	ILZTR6A-8G	94769		



CAR • SUV • LCV



Model	Type	Capacity	Year	Cyl	Engine	Gap	Recommended	Stock Code	Alternative	Stock Code
FORD										
ESCORT	1.3 GL, XR-3, SPORT	1300	1981->1986	4	CVH	0,8	BCP6ES	94000	BCPR6ES	96990
ESCORT	1.3 L	1300	1971->1981	4	KENT	0,8	BPR6ES	96989		
ESCORT	1.4 16V	1400	1995->2000	4	CVH/PTE	0,8	BCPR6ES	96990	BCP6ES	94000
ESCORT	1.6 GL, GLE16V	1600	1995->2000	4	ZETEC	1,3	TR5B-13	97667		
ESCORT	1.6 XR-3, GLE, L	1600	1983->1986	4	CVH	0,8	BCP6ES	94000	BCPR6ES	96990
ESCORT	1.8 GLI 16V	1800	1995->1998	4	ZETEC	1,3	TR5B-13	97667		
ESCORT	1.8 TD	1800	1990->2001	4	RVA ENDURA-DE (TC)		Y-937J	4118		
ESCORT	2.0 RS	2000	1978->1980	4	KOLN	0,8	AP6FS	2710	APR6FS	2922
EVEREST	2.2 XLS	2200	2014->	4	QJ		Y1045AS	97520		
EVEREST	3.0 TDCI	3000	2012->	4	WEAT		Y-526J1	92657		
EVEREST	3.2 TDCI	3200	2014->	5			Y1045AS	97520		
EXPLORER	4.0 V6	4000	2003->	6	EFI SOHC	1,3	ITR6F-13	4477	BPR6EFS-15	4871
EXPLORER	4.0 XLT V6	4000	2009->	6	EFI	1,5	TR55IX	7164	TR6IX	3689
EXPLORER SPORT	4.0 XLT V6	4000	2006->	6	KFI	0,8	TR7IX	3690		
F100	3.9 L	3900	1966->1981	6		0,8	AP6FS	2710	APR6FS	2922
F150	4.6 XL V8	4600	2009->	8	8FI	1,1	ZNAR6AIX-11	372		
F150	5.4 XL	5400	2009->	8	V8V	1,1	ZNAR6AIX-11	372		
F150	6.2 I	6200	2014->	8		1,1	LTR6IX-11	6509		
F250	4.2 SE V6	4200	2005->	6		1	TR5-1	7060		
F250	4.6 SE V6	4600	2005->	6		1,3	ITR6F-13	4477	BPR6EFS-15	4871
F250	4.9 V8 LCV	4900	1966->1981	8		0,8	AP6FS	2710	APR6FS	2922
F250	6.8 XL	6800	2009->	10	V10 YFI	1,1	ZNAR6AIX-11	372		
F350	4.2 V6	4200	2005->	6		1	TR5-1	7060		
F350	4.9 V8 LCV	4900	1974->1981	8		0,8	AP6FS	2710	APR6FS	2922
F350	7.3 DI	7300	2007->2010	8	V8		Y-1037J	97928		
FAIRMONT	4.0 L VR6	4000	2003->	8		1,1	PGR5C-11	5760		
FALCON	4.0 FUTURA, FAIRMONT	4000	1995->	6	INLINE	1,1	BPR5EY-11	95989		
FALCON	4.0 XR6	4000	1995->	6	INLINE	1,1	ZGR6B-11	4381		
FALCON	5.0 XR8	5000	1991->	8	EB, ED, EF	1,5	BPR5FS-15	3124		
FIESTA	150 ST (JH/JD)	2000	2004->	4	N4JB	1,3	ITR6F-13	4477	BPR6EFS-15	4871
FIESTA	1.0 T	1000	2013->	3	M1JE	0,7	SILZNAR8C-7H	93593	ILNAR8B7G	91970
FIESTA	1.0 T	1000	2013->	3	SFJA/SFJB	0,7	SILZNAR8C-7H	93593	ILNAR8B7G	91970
FIESTA	1.3 FUN, FLAIR	1300	1997->1998	4	HCS ENDURA	0,8	BPR6EFS	92170		
FIESTA	1.3 L	1300	2002->	4	ROCAM	1	TR6B-10	94480		
FIESTA	1.3 L	1300	2004->	4	DURATEC	1,3	TR5B-13	97667		
FIESTA	1.4 16V	1400	2001->	4	FXJB DURATEC	1,3	PTR5A-13	2467	TR5B-13	97667
FIESTA	1.4 FUN, FLAIR, FLITE	1400	1998->	4	CVH	0,8	BCPR6ES	96990	BCP6ES	94000
FIESTA	1.4 I	1400	2008->	4	SPJA/SPJC	0,8	TR5B-13	97667		
FIESTA	1.4 TD	1400	2006->	4	F6JA, F6JB D4TD		YE05	5207		
FIESTA	1.4 TDCI	1400	2005->	4	F6JA DURATORQ		YE05	5207		
FIESTA	1.4 TDCI	1400	2005->	4	F6JB		YE05	5207		
FIESTA	1.4 TDCI	1400	2010->	4	F6JD/KVJA		YE05	5207		
FIESTA	1.5 TDCI	1500	2013->	4	UGJC		Y8001AS	8851		
FIESTA	1.6 16V WS	1600	2001->2009	4	FYJA DURATEC	1,3	PTR5A-13	2467	TR5B-13	97667
FIESTA	1.6 I	1600	2010->	4	U5JA	1,3	TR6B-10	94480		
FIESTA	1.6 SPORT, RSI	1600	1999->	4	ROCAM	1,3	TR6B-10	94480		
FIESTA	1.6 ST	1600	2014->	4	JTDA/JTDB		ILZTR6A-8G	94769		
FIESTA	1.6 TDCI	1600	2005->	4	DURATORQ		YE05	5207		
FIESTA	1.6 TDCI	1600	2010->	4	TZJA/ TZJB		Y8001AS	8851		
FIESTA	1.6 TI-VCT	1600	2011->	4	PNDA	1,3	TR5B-13	97667		
FIGO	1.4 I	1400	2011->	4	DURATEC	1,3	TR5B-13	97667		
FIGO	1.4 TDCI	1400	2012->	4	F6JA, F6JB		YE05	5207		
FIGO	1.5 FIGO	1498	2018->	4			TR5B-13	97667		
FIGO	1.5 I	1500	2015->	4			TR5B-13	97667		
FIGO	1.6 I	1600	2011->	4	DURATEC	1,3	TR5B-13	97667		
FOCUS	1.0 T ECOBOOST	1000	2012->	3	M1DA	0,7	SILZNAR8C-7H	93593	ILNAR8B7G	91970
FOCUS	1.5 T	1500	2015->	4	M9DA	0,7	ILNAR8B7G	91970	SILZNAR8C-7H	93593
FOCUS	1.5 T	1500	2015->	4	M8DA	0,7	ILNAR8B7G	91970	SILZNAR8C-7H	93593
FOCUS	1.6 C-MAX	1600	2004->	4	DURATEC	1,3	TR5B-13	97667		
FOCUS	1.6 I	1600	2003->	4	DURATEC HWDA	1,3	TR5B-13	97667		
FOCUS	1.6 I	1600	2011->	4	PNDA	1,3	TR5B-13	97667		
FOCUS	1.6 L	1600	1995->	4	Z6	1,1	BKR5E-11	93674		
FOCUS	1.6 TDCI	1600	2005->	4	G8DA, G8BA DURA		YE05	5207		
FOCUS	1.6 TDI	1600	2011->	4	TD1DA/ TD1DB		Y8001AS	8851		
FOCUS	1.7 ST	2000	2003->	4	ZH20	1,3	PTR5A-13	2467	TR5B-13	97667
FOCUS	1.8 C-MAX	1800	2003->	4	DURATEC-HE CSDA CSDB	1,3	ITR6F-13	4477	BPR6EFS-15	4871
FOCUS	1.8 I	1800	2003->	4	DURATEC SCDA, SCDB	1,3	ITR6F-13	4477	BPR6EFS-15	4871
FOCUS	1.8 I	1800	2006->	4	QQDA DURATEC	1,3	TR6AP-13E	4968	BPR6EF-13	2402
FOCUS	1.8 I	1800	2006->	4	QQDD DURATEC	1,3	TR6AP-13E	4968		
FOCUS	1.8 TDCI	1800	1998->2004	4	ENDURA, DURATOR		Y-524J	5986		
FOCUS	1.8 TDCI	1800	2005->	4			Y-1005J	8939		
FOCUS	2.0 16V	2000	1998->	4	ZETEC	1,3	TR5B-13	97667		



CAR • SUV • LCV



Model	Type	Capacity	Year	Cyl	Engine	Gap	Recommended	Stock Code	Alternative	Stock Code
FORD										
FOCUS	2.0 16V	2000	2004->	4	DURATEC	1,3	ITR6F-13	4477	BPR6EFS-15	4871
FOCUS	2.0 16V	2000	2006->	4	SYDA DURATEC	1,3	ITR6F-13	4477	BPR6EFS-15	4871
FOCUS	2.0 16V	2000	2009->	4	DURATEC-HE SFI	1,3	ITR6F-13	4477	BPR6EFS-15	4871
FOCUS	2.0 C-MAX	2000	2004->	4	AODA AODB	1,3	ITR6F-13	4477	BPR6EFS-15	4871
FOCUS	2.0 GDI	2000	2011->2015	4	TPWA	0,8	ILTR6G-8G	96621		
FOCUS	2.0 I	2000	2011->	4	XQDA	0,9	LTR6BI-9	92182		
FOCUS	2.0 ST	2000	2012->	4	R9DA	0,8	LTR6DI-8	96588		
FOCUS	2.0 ST 170	2000	2004->	4	ALDA DURETEC	0,8	ILTR6A-8G	3787	TR6B-10	94480
FOCUS	2.0 TDCI	2000	2004->2007	4	G6DA,G6DB,G6DD		Y-1005J	8939		
FOCUS	2.0 TDCI	2000	2011->	4	TXDB		Y8001AS	8851		
FOCUS	2.3 RS	2300	2012->	4	C23HDOD	0,8	LTR6DI-8	96588		
FOCUS	2.3 ST	2300	2005->2006	4	DURATEC L4Z	1,3	ITR6F-13	4477	BPR6EFS-15	4871
FOCUS	2.5 RS	2500	2010->	5	JZDA	0,8	ILFR6B	6481	LF6B	6677
FOCUS	2.5 ST	2500	2006->	5	B5254T4 HYDA DURATEC	0,8	ILFR6B	6481		
FUSION	1.4 I	1400	2002->	4	FXJA/ FXJB	1,3	PTR5A-13	2467	TR5B-13	97667
FUSION	1.5 T	1500	2014->	4	M9MA	0,7	ILZNA8A7G	91924		
FUSION	1.6 I	1600	2002->	4	FYJA/ FYJB	1,3	PTR5A-13	2467	TR5B-13	97667
FUSION	2.0 ECOBOOST	2000	2014->	4	R9CB	0,8	ILTR6H-8G	96870		
FUSION	2.0 ECOBOOST	2000	2015->	4	TNCD	0,8	LTR6DI-8	96588		
FUSION	2.0 ECOBOOST TITANIUM	2000	2015->	4	R9CH	0,8	LTR6DI-8	96588		
FUSION	2.0 TDCI TITANIUM	2000	2015->	4	T8CC		Y8001AS	8851		
GALAXY	1.9 TDI	1900	1999->2000	4	AVG, ANU		Y-732J	5909		
GALAXY	2.0 I	2000	1995->	4	NSE	0,8	BKR8EIX	2668		
GRANADA	2.0 GL, GLE	2000	1978->1985	4	KOLN	0,8	AP6FS	2710	APR6FS	2922
GRANADA	3.0 GHIA	3000	1978->1986	6	ESSEX	0,8	BPR6ES	96989		
GRANADA	3.0 GLE	3000	1978->1986	6	ESSEX	0,8	BPR6ES	96989		
HUSKY	1.8 1TON PICKUP	1800	1985->1987	4	4G62	0,8	BPR5ES	94084		
HUSKY	2.0 PANEL VAN,PICK-UP,BUS	2000	1986->1990	4	4G63	0,8	BPR6ES	96989		
IKON	1.3 I	1300	2002->	4	ROCAM	1,3	TR5B-13	97667		
IKON	1.4 16V	1400	2008->	4	FXJB	1,3	PTR5A-13	2467	TR5B-13	97667
IKON	1.4 TDCI	1400	2005->	4	F6JB		YE05	5207		
IKON	1.4 TDCI	1400	2005->	4	FJ6A		YE05	5207		
IKON	1.4 TDCI	1400	2010->	4	F6JD/KVJA		YE05	5207		
IKON	1.6 I	1600	2002->	4	ROCAM	1	TR6B-10	94480		
KA	1.2 I	1200	2008->	4	FP4	1	ZKR7A-10	1691		
KA	1.3 I	1300	2003->	4	DURATEC/ROCAM	1,3	TR5B-13	97667		
KA	1.3 I	1300	2003->	4	ENDURA	1,3	BPR5EFS-13	2359		
KA	1.6 SPORTKA	1600	2003->	4	DURATEC/ROCAM	1,3	TR5B-13	97667		
KA	1.6 STREETKA	1600	2003->2005	4	DURATEC	1,3	PTR5A-13	2467	TR5B-13	97667
KUGA	1.5 T	1500	2014->	4	M9MA	0,7	ILZNA8A7G	91924		
KUGA	1.5 T	1500	2015->	4	M9MA	0,7	ILNAR8B7G	91970	SILZNA8C-7H	93593
KUGA	1.6 ECO BOOST	1600	2012->	4	JOM	0,8	ILZTR6A-8G	94769		
KUGA	1.6 ECO BOOST	1600	2012->	4	JTM	0,8	ILZTR6A-8G	94769		
KUGA	2.0 TDCI	2000	2010->2012	4	DURATORQ		Y-1005J	8939		
KUGA	2.0 TDCI	2000	2012->	4	TXMA		Y8001AS	8851		
KUGA	2.5 TURBO	2500	2011->	5	DURATEC	0,8	ILFR6B	6481	LF6B	6677
LASER	1.3 L,GL	1300	1986->1989	4	E3	0,8	BPR5ES	94084		
LASER	1.3 TRACER	1300	1991->1995	4	B3	0,8	BPR5ES	94084		
LASER	1.4 L,LX	1400	1989->1992	4	CVH	0,8	BCP6ES	94000	BCPR6ES	96990
LASER	1.4 S	1400	1989->1992	4	CVH	0,8	BCPR6ES	96990	BCP6ES	94000
LASER	1.5 GL,GLS	1500	1986->1989	4	E5,B5,SPORT	0,8	BPR5ES	94084		
LASER	1.6 GL,GLE,SPORT	1600	1989->1992	4	CVH	0,8	BCP6ES	94000	BCPR6ES	96990
LASER	1.6 I SPORT ,TX3,TRACER	1600	1986->1996	4	B6	0,8	BPR6ES	96989		
LASER	1.6 L	1600	1989->1992	4	CVH	0,8	BCPR6ES	96990	BCP6ES	94000
LASER	2.0 I RS 16V	2000	1991->1994	4	FE-EGI T/C	0,8	BCPR6ES	96990	BCP6ES	94000
METEOR	1.3 GL	1300	1986->1991	4	E3	0,8	BPR5ES	94084		
METEOR	1.3 TRACER	1300	1991->	4	B3	0,8	BPR6ES	96989		
METEOR	1.4 L	1400	1989->	4	CVH	0,8	BCPR6E	96245		
METEOR	1.5 GL, GLS	1500	1986->1989	4	E5 + B5	0,8	BPR5ES	94084		
METEOR	1.6 GLI	1600	1986->1989	4	B6	0,8	BPR6ES	96989		
METEOR	1.6 L	1600	1989->1992	4	CVH	0,8	BCP6ES	94000	BCPR6ES	96990
METEOR	2.0 GLE 8V	2000	1991->1994	4	FE-EGI T/C	0,8	BCPR6E	96245		
METEOR	2.0 GLI 16V	2000	1991->1994	4	FE-EGI T/C	0,8	BCPR6E	96245		
MONDEO	1.6 TDCI	1600	2014->	4	NGCA		Y8001AS	8851		
MONDEO	1.8 I LX	1800	1998->2000	4	ZETEC	1,3	TR5B-13	97667		
MONDEO	2.0 16V	2000	2009->	4	DURATEC-HE	1,3	ITR6F-13	4477		
MONDEO	2.0 CLX	2000	1998->2000	4	ZETEC	1,3	TR5B-13	97667		
MONDEO	2.0 I	2000	2000->	4	DURATEC	1,3	ITR6F-13	4477		
MONDEO	2.0 TDCI	2000	2014->	4	T7CC		Y8001AS	8851		
MONDEO	2.0 TDCI	2000	2014->	4	T8CC		Y8001AS	8851		
MONDEO	2.3 TI-VCT	2300	2007->	5	SEBA DURATEC	1,3	ILTR5A-13G	3811	TR5B-13	97667
MONDEO	2.5 SI V6	2500	1998->2000	6	DURATEC	0,8	BPR6EFS	92170		

FORD



CAR • SUV • LCV



Model	Type	Capacity	Year	Cyl	Engine	Gap	Recommended	Stock Code	Alternative	Stock Code
FORD										
MONDEO	3.0 ST220	3000	2003->	6	DURATEC	1,3	ITR6F-13	4477		
MUSTANG	2.3 T ECOBOOST	2300	2014->	4	C23HDD	0,8	LTR6DI-8	96588		
RANCHERO	4.0 OUTBACK, GLI	4000	1997->1998	6	INLINE	1,1	BPR5EY-11	95989		
RANCHERO	4.0 XR6	4000	1997->1998	6	INLINE	1,1	ZGR6B-11	4381		
RANCHERO	4.1 XR6	4100	1986->	6		0,8	AP6FS	2710	APR6FS	2922
RANCHERO	4.9 V8	4900	1988->	8		0,8	BP6FS	3512	BPR6FS	2623
RANGER	1.8 I	1800	2000->	4	F8	0,8	BPR5E5	94084		
RANGER	2.2 12V	2200	2007->	4	F2 EFI	0,8	BPR5E5	94084		
RANGER	2.2 12V CARB	2200	2000->2006	4	F2	0,8	BKR6E	97737		
RANGER	2.2 I	2200	2012->	4		1,3	ILTR5K-13	90607		
RANGER	2.2 TDCI	2200	2012->	4	QJ		Y1045AS	97520		
RANGER	2.3 XLT	2300	2009->	4	DFI	1,3	ITR6F-13	4477		
RANGER	2.5 D	2500	1999->2006	4	WL		Y-701J	5116		
RANGER	2.5 I	2500	2009->	4	DPAT	1,3	ILTR6A-13G	3789	TR6B-10	94480
RANGER	2.5 TD	2500	1999->2006	4	WL-T		Y-701J	5116		
RANGER	2.5 TD	2500	2006->	4	WLAA		Y-526J1	92657		
RANGER	2.5 XL	2500	2009->	4	DFI	1,3	ITR6F-13	4477		
RANGER	2.5 XL	2500	2013->	4		1,3	ILTR5K-13	90607		
RANGER	2.5 XLT	2500	2009->	4	WLAT		Y-526J1	92657		
RANGER	2.6 L 12V	2600	1999->	4		0,8	BKR5E	92870		
RANGER	3.0 TDCI	3000	2008->	4	WEAT		Y-526J1	92657		
RANGER	3.2 TDCI	3200	2012->	5	SAFA		Y1045AS	97520		
RANGER	4.0 V6	4000	2003->	6		1,3	ITR6F-13	4477	BPR6EFS-15	4871
RANGER	4.0 XL	4000	2006->	6	EFI	1,3	ITR6F-13	4477	BPR6EFS-15	4871
SAPPHIRE	1.6 L	1600	1989->1991	4	KENT	0,8	BPR6ES	96989		
SAPPHIRE	2.0 GL, GLE	2000	1989->1993	4	KOLN	0,8	APR6FS	2922		
SAPPHIRE	2.0 I GLI, EXEC	2000	1989->1993	4	KOLN	0,8	APR6FS	2922		
SAPPHIRE	3.0 GHIA	3000	1991->1993	6	ESSEX	0,8	BPR7ES	95164		
SAPPHIRE	3.0 GLX	3000	1989->1993	6	ESSEX	0,8	BPR7ES	95164		
SIERRA	1.6 GL	1600	1983->1989	4	KENT	0,8	BPR6ES	96989		
SIERRA	2.0 GL, LX	2000	1983->1993	4	KOLN	0,8	AP6FS	2710	APR6FS	2922
SIERRA	2.3 GLE	2300	1983->1986	6	KOLN	0,8	BPR6ES	96989		
SIERRA	3.0 GLS	3000	1984->1989	6	ESSEX	0,8	BPR6ES	96989		
SIERRA	3.0 GLX	3000	1989->1993	6	ESSEX	0,8	BPR7ES	95164		
SIERRA	3.0 I RS	3000	1991->1993	6	ESSEX	0,8	BPR7ES	95164		
SIERRA	3.0 XR-6	3000	1989->1992	6	ESSEX	0,8	BPR7ES	95164		
SPECTRON	2.2 BUS	2200	1991->1996	4	F2	0,8	BKR6E	97737		
TELSTAR	2.0 GLI, V6	2000	1993->1996	6	KF	1,1	BKR6E-11	94306		
TELSTAR	2.0 GL, GLE	2000	1993->1997	4	FS	1,1	BKR6E-11	94306		
TELSTAR	2.5 GHIA TX5 V6	2500	1993->1996	6	KL	1,1	BKR6E-11	94306		
TERRITORY	4.0 I	4000	2002->	6	VCT BARRA	1,3	FR5E1-13	6705	BKR5E-11	93674
TOURNEO	1.8 D CONNECT	1800	2002->	4	HCPA DURATORQ-TDCI		Y-524J	5986		
TOURNEO CONNECT	1.0 T ECOBOOST	1000	2013->	3	M2GA	0,7	SILZNR8C-7H	93593	ILNAR8B7G	91970
TOURNEO CONNECT	1.6 T ECOBOOST	1600	2013->	4	JQJA	0,8	ILZTR6A-8G	94769		
TOURNEO CONNECT	1.6 TDCI	1600	2013->	4	T1GA		Y8001AS	8851		
TOURNEO CUSTOM	2.2 TDCI	2200	2013->	4			Y1045AS	97520		
TOURNEO CUSTOM	2.2 TDCI	2200	2013->	4			Y1045AS	97520		
TRANSIT	1.8 D	1800	2002->	4	BHPA ENDURA		Y-524J	5986		
TRANSIT	1.8 D	1800	2002->	4	HCPA DURATORQ		Y-524J	5986		
TRANSIT	1.8 L	1800	2002->	4	EYPC ZETEC-E	1,3	TR5B-13	97667		
TRANSIT	1.8 S	1800	2002->	4	EYPA ZETEC-E	1,3	PTR5A-13	2467	TR5B-13	97667
TRANSIT	2.2 DT	2200	2006->	4	DOHC		Y-548J	96037		
TRITON	2.6 SWB	2600	1985->1986	4	4G54	0,8	BPR6ES	96989		
FOTON										
INKUNZI	2.2 I	2000	2008->	4		0,8	BPR6ES	96989		
VIEW	2.2 I	2200	2008->	4		0,8	BPR6ES	96989		
FUDI										
PICK-UP	2.2 I	2200	2007->	4	4Y	0,8	BPR5EY	94270		
PICK-UP	2.8 TD	2800	2007->	4	4JB1		Y-904M1	7995		
GAZ										
5601	2.2 TURBO	2200	2006->	4			Y-732J	5909		
GEELY										
CK	1.3 GB,GS	1300	2007->	4		0,8	BKR6ES-11	94437		
CK	1.5 GL,GT	1500	2007->	4		0,8	BKR6ES-11	94437		



CAR • SUV • LCV



Model	Type	Capacity	Year	Cyl	Engine	Gap	Recommended	Stock Code	Alternative	Stock Code
GONOW										
JETSTAR	2.8 TD	2800	2007->	4	4JB1		Y-904M1	7995		
X-SPACE	2.2 I DC	2200	2007->2007	4	4Y	0,8	BPR5EY	94270		
X-SPACE	2.2 I XL DCEXT	2200	2007->	4	4Y	0,8	BPR5EY	94270		
X-SPACE	2.2 IL DC	2200	2007->	4	4Y	0,8	BPR5EY	94270		
X-SPACE	2.2 IX DCEXT	2200	2007->	4	4Y	0,8	BPR5EY	94270		
GWM										
C30	C30	1497	2014->	4	GW4G15		BKR6E	97737		
C20R	C20R	1497	2013->	4	GW4G15		BKR6E	97737		
C50	C50	1497	2014->	4	GW4G15T		BKR7EIX	2667	BCPR7ES	93606
DOUBLE CAB	2.2 I	2200	2007->	4	4Y	0,8	BPR5EY	94270		
FLORID	1.5 I	1500	2010->	4	GW4G15	0,8	BKR6E	97737		
HAVAL H2	1.5 TURBO	1500	2016->	4	GW4G15B	0,8	BKR7EIX	2667		
HAVAL H6	1.3 TURBO	1300	2015->	4	4B13	1,1	SIFR6B7G	94675	SIFR6A-11	127
HAVAL H6	1.5 TURBO	1500	2015->	4	4B15	1,1	SIFR6B7G	94675	SIFR6A-11	127
HAVAL H6	2.0	2000	2015->	4	GW4C20	1,1	SIFR6B7G	94675	SIFR6A-11	127
HAVAL H6	1.5 TURBO	1500	2011->2015	4	4GW15B	1,1	SIFR6B7G	94675	SIFR6A-11	127
HAVAL H9	2.0 TURBO	2000	2015->	4	GW4C20A	1,1	SIFR6B7G	94675	SIFR6A-11	127
HOVER	2.4 FI	2400	2007->	4	4G64	0,8	BKR5E	92870		
MULTI WAGON	2.2 I	2200	2007->	4	4Y	0,8	BPR5EY	94270		
SINGLE CAB	2.2 I	2200	2007->	4	4Y	0,8	BPR5EY	94270		
SINGLE CAB	2.5 D	2500	2007->	4			Y-904M1	7995		
STEED 5	2.2 I	2200	2009->	4	4910E	0,8	BPR6ES	96989		
STEED 5	2.4 I	2400	2009->	4	4G94S4N	1,1	BKR6E-11	94306		
G.M.C										
ENVOY	5.3 EFI	5300	2007->	8	LMG	1,5	TR55IX	7164	TR6IX	3689
YUKON	5.3 XL1500	5300	2005->	8	T/FI	1,5	TR55IX	7164	TR6IX	3689
YUKON	6.0 XL2500SE	6000	2005->	8	N/FI	1,5	TR55IX	7164	TR6IX	3689
YUKON	6.2 FV8	6200	2006->2006	8	L92	1,1	PZTR5A-15		BPR5EFS-13	2359
HAVAL										
H1	H1	1497	2016->	4	GW4G15		BKR7EIX	2667	BCPR7ES	93606
H6	2.0 H6C	GW4C20	2017->	4	GW4C20		SIFR6B7G	94675		
H6	H6	1497	2017->	4	GW4G15E		SIFR6B7G	94675		
HONDA										
ACCORD	2.0 E	2000	2004->	4	K20A6	1,1	ZFR6K-11	6711		
ACCORD	2.0 VTEC	2000	2008->	4	R20A3	1,1	IZFR6K-11S	5266		
ACCORD	2.2 I-DTEC	2200	2003->2008	4	N22A1		CZ274	95233		
ACCORD	2.2 I-DTEC	2200	2008->2015	4	N22B1		CZ274	95233		
ACCORD	2.2 I-DTEC	2200	2010->2015	4	N22B2		CZ274	95233		
ACCORD	2.2 TURBO	2200	1999->2003	4	H22A7	1,1	PZFR6F-11	3271	ZFR6F-11	93208
ACCORD	2.3 VTEC	2300	2003->	4	H23A3	1,1	ZFR6F-11	93208		
ACCORD	2.4 EX-L	2400	2009->	4	K24Z3 FI	1,1	ILZKR7B-11S	5787		
ACCORD	2.4 VTEC	2400	2003->	4	K24A3	1,1	ZFR6K-11	6711		
ACCORD	2.4 VTEC	2400	2007->	4	K24A8	1,1	IZFR6K-11	6994	ZFR6K-11	6711
ACCORD	2.4 VTEC	2400	2013->	4	K24W3	1,1	ILKAR7K-11S	90255		
ACCORD	3.0 LX	3000	1998->	6	J30A1	1,1	ZFR5F-11	93814		
ACCORD	3.0 V6	3000	2006->2007	6	FI	1,1	PZFR6F-11	3271	ZFR6F-11	93208
ACCORD	3.5 EX-L	3500	2009->	6	J35Z2 FI	1,1	ILZKR7B-11S	5787		
AMAZE	1.2L	1198	2018->	4	L12B3		BKR6E-11	94306		
BALLADE	1.3 L	1300	1984->1989	4	EV2	1,1	BPR6EY-11	96705		
BALLADE	1.3 SX	1300	1982->1985	4	EN4	0,8	BPR6ES	96989		
BALLADE	1.5 FI	1500	1989->1992	4	D15B8	1,1	BCPR6ES-11	90010		
BALLADE	1.5 FI	1500	1992->1996	4	D15B3	1,1	BCPR6ES-11	90010		
BALLADE	1.5 I	1500	1985->1989	4	EW2	1,1	BPR6EY-11	96705		
BALLADE	1.5 I	1500	2012->	4	L15A	1,3	IZFR6K-13	6774		
BALLADE	1.5 L	1500	1984->1989	4	D15Z4	1,1	BKR6E-11	94306		
BALLADE	1.6 DOHC	1600	1992->	4	D16A9	1,1	BKR6E-N-11	5724		
BALLADE	1.6 SOHC	1600	1989->1992	4	D16A7	1,1	BKR6E-11	94306		
BALLADE	1.6 VTEC	1600	1996->2000	4	D16A1	1,1	BKR6E-N-11	5724		
BALLADE	1.6 IE	1600	1992->1994	4	D16Z6	1,1	BCPR6E-11	96438		
BALLADE	1.6 SE	1600	1996->2000	4	D16 Y9	1,1	BKR6E-11	94306		
BALLADE	1.8 E	1800	1994->1996	4	B18B3	1,1	BKR6E-N-11	5724		
BALLADE	1.8 I	1800	1994->1996	4	B18C4	1,1	BKR6E-N-11	5724		
BALLADE	1.8 I	1800	1999->	4	B18B4	1,1	BKR5E-11	93674		
BRIO	1.2 I	1200	2013->	4	L12	1,1	BKR6E-11	94306		



CAR • SUV • LCV



Model	Type	Capacity	Year	Cyl	Engine	Gap	Recommended	Stock Code	Alternative	Stock Code
HONDA										
BRV	1.5 I	1500	2016->	4	L15Z2	1,3	DIFR6D-13	94167		
CIVIC	1.4 VTEC	1400	2012->	4	L13Z4	1,3	IZFR6K-13	6774		
CIVIC	1.5 VTEC	1500	2001->	4	D15Z6	1,1	BKR6E-N-11	5724		
CIVIC	1.5 16V	1500	1996->2000	4	D15Z6	1,1	BKR6E-11	94306		
CIVIC	1.5 CIVIC SPORT	1498	2016->	4	L15B7		ILZKAR8H8S	95112		
CIVIC	1.5 I	1500	2001->	4	VTI	1,1	BKR6E-N-11	5724		
CIVIC	1.6 VTEC	1600	1996->2000	4	B16A1	1,1	BKR6E-N-11	5724		
CIVIC	1.6 I	1600	1989->1992	4	D16A7	1,1	BKR6E-11	94306		
CIVIC	1.6 I	1600	1996->2000	4	D16Y6	1,1	BKR6E-11	94306		
CIVIC	1.6 I	1600	2001->	4	D16V1	1,1	ZFR6J-11	5585		
CIVIC	1.6 I-DTEC	1600	2013->	4	N16A1		CZ274	95233		
CIVIC	1.6 VTEC	1600	2012->	4	R16B	1,1	SILZKR7C-11S	92932		
CIVIC	1.7 VTEC	1700	2001->2005	4	D17A6	1,1	ZFR6F-11	93208		
CIVIC	1.8 VTEC	1800	2001->	4	B18C4	1,1	BKR6E-N-11	5724		
CIVIC	1.8 I	1800	2006->	4	R18A1	1,1	IZFR6K-11S	5266	ZFR6K-11	6711
CIVIC	1.8 I-VTEC	1800	2012->	4	R18Z1	1,1	SILZKR7C-11S	92932		
CIVIC	2.0 IVTEC R	2000	2017->	4	K20C1	0,8	ILZKAR8H8S	95112		
CIVIC	2.0 SI	2000	2009->	4	K20Z4	1,1	IFR7G-11KS	7746		
CIVIC	2.0 TYPE-R	2000	2001->2006	4	K20A2	1,1	IFR7G-11KS	7746		
CIVIC	2.0 TYPE R FN2	2000	2007->	4	K20Z4	1,1	IFR7G-11KS	7746		
CIVIC	2.0 VTEC R	2000	2015->	4	K20C1	0,8	ILZKAR8H8S	95112		
CIVIC	2.2 I-DTEC	2200	2005->2011	4	N22A2		CZ274	95233		
CIVIC	2.2 I-DTEC	2200	2012->	4	N22B4		CZ274	95233		
CIVIC	2.0 SI	2000	2011->	4	K20Z3	1,1	IFR7G-11KS	7746		
CONCERTO	1.8 TD	1800	1994->1995	4	XUD 7 TE		Y-924J	3473		
CR-Z	1.5 ELEC	1500	2011->	4	LEA1	1,3	DIFR6D-13	94167		
CRV	1.5 T	1500	2017->	4		0,8	ILZKAR8J8SY	95660		
CRV	1.6 I-DTEC	1600	2013->	4	N16A2		CZ274	95233		
CRV	1.6 I-DTEC	1600	2015->	4	N16A4		CZ274	95233		
CRV	2.0 AWD RES, RM2	2000	2012->	4	R20A9	1,1	SILZKR7C-11S	92932	DILZKAR7C11S	90137
CRV	2.0 I	2000	1997->1999	4	DOHC	1,1	ZFR5F-11	93814		
CRV	2.0 RE5	2000	2007->	4	R20A2	1,1	IZFR6K-11	6994	ZFR6K-11	6711
CRV	2.0 RE5	2000	2007->	4	R20A2	1,1	IZFR6K-11	6994	ZFR6K-11	6711
CRV	2.0 SE	2000	2002->	4	K20A4	1,1	ZFR6K-11	6711		
CRV	2.0 S,LS,ES	2000	2000->	4	B20Z1	1,1	ZFR6F-11	93208		
CRV	2.0 VTEC	2000	2003->	4	K20A4	1,1	IZFR6K-11	6994	ZFR6K-11	6711
CRV	2.2 I-CTDI	2200	2005->2006	4	N22A2		CZ274	95233		
CRV	2.2 I-DTEC	2200	2009->2012	4	N22B3		CZ274	95233		
CRV	2.2 I-DTEC	2200	2012->	4	N22B4		CZ274	95233		
CRV	2.4 FI	2400	2007->	4	K24Z1	1,1	IZFR6K-11	6994	ZFR6K-11	6711
CRV	2.4 VTEC	2400	2009->	4	K24Z1	1,1	IZFR6K-11	6994	ZFR6K-11	6711
CRX	1.6 I	1600	1987->1989	4	D16A9	1,1	BCPR6E-11	96438		
ELEMENT	2.4 FI	2400	2007->	4	K24A4	1,1	IZFR6K-11	6994	ZFR6K-11	6711
FRV	1.7 VTEC	1700	2005->	4	D17A2	1,1	ZFR6K-11	6711		
FRV	1.8 VTEC	1800	2007->	4	R18A1	1,1	IZFR6K-11S	5266	ZFR6K-11	6711
FRV	2.0 VTEC	2000	2005->	4	K20A9	1,1	IZFR6K-11	6994	ZFR6K-11	6711
FRV	2.2 I-CTDI	2200	2005->2009	4	N22A1		CZ274	95233		
HRV	1.5 CVT	1500	2015->	4	L15B4	1,1	DILZKAR7C11S	90137		
HRV	1.6 I-DTEC	1600	2015->	4	N16A3		CZ274	95233		
HRV	1.6 SX	1600	2001->	4	D16W1	1,1	ZFR6F-11	93208		
INSIGHT	1.3 ELECTRIC	1300	2010->	4	LDA3	1,1	DILFR6J-11	92491		
INTEGRA	2.0 TYPE R	2000	2002->	4	K20A	1,1	IFR7G-11KS	7746		
JAZZ	1.2 I	1200	2008->	4	L12B1	1,3	DIFR6D-13	94167		
JAZZ	1.3 ELECTRIC	1300	2012->	4	LDA3	1,1	DILFR6J-11	92491		
JAZZ	1.3 I	1300	2006->	4	L13A6	1,1	BKR6E-11	94306		
JAZZ	1.3 I	1300	2009->	4	SOHC	1,3	IZFR6K-13	6774		
JAZZ	1.4 HYBRID	1400	2011->	4	LDA3	1,1	DILFR6J-11	92491		
JAZZ	1.4 I	1400	2002->	4	L13A1	1,1	BKR6E-11	94306		
JAZZ	1.4 I	1400	2006->	4	L13A6	1,1	BKR6E-11	94306		
JAZZ	1.4 I	1400	2009->	4	L13Z1	1,3	IZFR6K-11	6994	ZFR6K-11	6711
JAZZ	1.4 I DSI TWIN-SPARK	1400	2003->	4	L13Z1	1,1	BKR6E-11	94306		
JAZZ	1.5 I	1500	2006->	4	L15A	1,1	IZFR6K-11	6994	ZFR6K-11	6711
MOBILIO	1.5 I	1500	2014->	4	L15A	1,3	DIFR6D-13	94167		
ODYSSEY	2.3 I	2300	1998->1999	4	H23A2	1,1	ZFR6F-11	93208		
ODYSSEY	2.4 I 16V	2400	2000->	4		1,1	ZFR6F-11	93208		
ODYSSEY	3.5 I	3500	2007->	6	J35A7	1,1	IZFR6K-11	6994	ZFR6K-11	6711
PRELUDE	1.8 EX	1800	1984->1987	4	ET	0,8	BPR6ES	96989		
PRELUDE	2.0 16V	2000	2000	4	B20A7	1,1	BCPR6E-11	96438		
PRELUDE	2.1	2056	1990->1991	4	B21A1		BCP6E-11	1080	BCPR6E-11	96438
PRELUDE	2.2 16V	2200	2000	4	F22A	1,1	ZFR6F-11	93208		
PRELUDE	2.2 VTEC	2200	1997->2000	4	H22A5	1,1	PZFR6F-11	3271	ZFR6F-11	93208
S2000	2.0 VTEC	2000	2000->2002	4	F20C1	1,1	PFR7G-11	2380	BCPR7ES	93606



CAR • SUV • LCV



Model	Type	Capacity	Year	Cyl	Engine	Gap	Recommended	Stock Code	Alternative	Stock Code
HONDA										
S2000	2.2 VTEC	2200	2007->	4	F22C1	1,1	IFR7G-11KS	7746		HONDA
STREAM	1.7 VTEC	1700	2001->	4	D17A2	1,1	ZFR6F-11	93208		
HUMMER										
H2	6.0 I V8	6000	2003->2006	8	N EFI	1,3	ITR6F-13	4477	BPR6EFS-15	4871
H3	3.7 I	3700	2007->	6	L5	1,1	ILTR5B-11	3474	TR5B-13	97667
HYUNDAI										
ACCENT	1.3 G	1300	1999->2006	4	G4EA	1,1	BKR5E-11	91130		
ACCENT	1.3 XS, LS	1300	1996->1999	4	G4EH	1,1	BKR5E-11	91130		
ACCENT	1.5 CSI, RSI	1500	1994->1999	4	G4EB	1,1	BKR5E-11	91130		
ACCENT	1.5 SX	1500	2000->2006	4	G4EB	1,1	BKR5E-11	91130		
ACCENT	1.6 I	1600	2012->	4	G4FC	1	LZKR6B-10E	1578		
ACCENT	1.6 LX	1600	2006->	4	G4ED	1,1	BKR5E-11	91130		
ATOS	1.0 PRIME	1000	2001->	4	G4HC	1,1	BKR5E-11	91130		
ATOS	1.1 PRIME	1100	2005->	4	G4HG	1,1	BKR5E-11	91130		
AZERA	3.3 V6	3300	2006->	6	G6DB	1,1	IFR5G-11	7854	BKR5E-11	93674
CRETA	1.6 CRDI	1600	2015->	4	D4FB		Y-527J	91843		
ELANTRA	1.5 I	1500	1995->2005	4	G4EK, G4EB	1,1	BKR5E-11	91130		
ELANTRA	1.6 CVVT	1600	2010->	4	G4FC	1	LZKR6B-10E	1578		
ELANTRA	1.6 GL	1600	2008->	4	G4GA	1,1	ZFR5F-11	93814		
ELANTRA	1.6 GLS	1600	2007->	4	G4GA	1,1	BKR5E-11	91130		
ELANTRA	1.6 GLS EXEC.	1600	1993->1995	4	J1 G4DMR	1,1	BPR6E-11	94967		
ELANTRA	1.6 GL, GLS EXEC.	1600	1996->	4	J2 G4DR	1,1	BKR5E-11	91130		
ELANTRA	1.6 I	1600	2012->	4	G4FC	1	LZKR6B-10E	1578		
ELANTRA	1.8 CVVT	1800	2011->2012	4	L4	1,1	SILZKR6B-11	6215		
ELANTRA	1.8 CVVT	1800	2013->	4	L4	1,1	SILZKR7B-11	9723		
ELANTRA	1.8 GLI	1800	1996->	4	J2 G4DR	1,1	BKR5E-11	91130		
ELANTRA	1.8 GLS	1800	1994->	4	J1 G4DN	1,1	BPR6E-11	94967		
ELANTRA	1.8 GLS	1800	1996->	4	J2 G4DN	1,1	BKR5E-11	91130		
ELANTRA	2.0 CRDI	2000	2001->	4	D4EA		Y-749J	5013		
ELANTRA	2.0 GLS	2000	2003->	4	G4FG	1,1	BKR5E-11	93674		
ELANTRA	2.0 GS	2000	2008->	4	G4GC	1,1	BKR5E-11	93674		
ELANTRA	2.0 TOURING	2000	2010->	4	G4GC	1,1	IFR5E-11	7994	BKR5E-11	93674
GENESIS	3.8 COUPE	3800	2008->	6	G6DA	1,1	SILZKR7B-11	9723		
GETZ	1.3 I	1300	2004->2008	4	G4EA	1,1	BKR5E-11	91130		
GETZ	1.4 I	1400	2005->2008	4	G4EE	1,1	BKR5E-11	91130		
GETZ	1.5 CRD	1500	2004->	4	D3EA		Y-527J	91843		
GETZ	1.6 GL	1600	2003->	4	G4ED	0,8	BCPR6ES	96990	BCP6ES	94000
GETZ	1.6 HS	1600	2007->	4	G4ED	0,8	BCPR6ES	96990	BCP6ES	94000
GRAND I10	1.25 I	1250	2012->	4	G4LA		PLKR7A	4288	LKR7B-9	5847
H1	2.4 I	2400	2008->	4	L4	1,1	IFR5A-11	95304		
H1	2.5 CRDI	2500	2012->	4	D4BB		CZ257	96868		
H1	2.5 D	2500	2000->	4	D4BF, D4BH		Y-722JS	9974		
H100	2.4 I	2400	1997->	4		1,1	BP6EY-11	4128	BPR6EY-11	96705
H100	2.5 D	2500	1993->1994	4	D4BX		CZ257	96868		
H100	2.5 D	2500	1994->1996	4	D4BA		Y-115T-1	2189		
H100	2.5 TD	2500	2006->	4	4D56T		CZ257	96868		
H100	2.6 D	2600	1997->	4	D4BB		Y-115T-1	2189		
I10	1.1 I	1100	2008->	4	G4HG	1,1	BCPR6ES-11	90010		
I10	1.2 I	1200	2008->2010	4	G4LA	1	PLKR7A	4288		
I10	1.2 I	1200	2011->	4	G4LA	0,8	PLKR7A	4288	LKR7B-9	5847
I20	1.2 I	1200	2008->	4	G4LA	0,8	PLKR7A	4288		
I20	1.2 I		2014->	4	G4AG		SILKR6C-10E			
I20	1.4 ACTIVE (IB, GB)	1400	2014->	4	G4LC		SILKR6C10E	97098		
I20	1.4 CRDI	1400	2009->	4	D4FC		Y-527J	91843		
I20	1.4 FI	1400	2008->2008	4	G4FA	1,1	ZFR5F-11	93814		
I20	1.4 FI	1400	2009->	4	G4FA	1	LZKR6B-10E	1578		
I20	1.6 I	1600	2009->	4	G4FC	1,1	ZFR5F-11	93814		
I20	1.6 I	1600	2009->	4	G4FC	1	LZKR6B-10E	1578		
I30	1.6 GDI	1600	2011->	4	G4FD	1	SILZKR6B-10E	93815		
I30	1.6 I	1600	2009->	4	G4FC	1	LZKR6B-10E	1578		
I30	1.8 I	1800	2013->	4		0,8	SILZKR7B-11	9723		
I30	2.0 I	2000	2008->	4	G4GC	1,1	BKR5E-11	91130		
IX35	2.0 CRDI	2000	2009->	4	D4HA		Y-1003AS	92283		
IX35	2.0 I	2000	2010->	4	G4KD	1,1	IFR5A-11	95304		
IX35	2.0 I	2000	2015->	4	G4NC	1,1	SILZKR7B-11	9723		
IX35	2.4 I	2400	2010->	4	G4KE	1,1	IFR5A-11	95304		
KONA	T-GDI	998	2018->		G3LC		ILKR9G8	97168		
MATRIX	1.6 I	1600	2004->	4	G4ED	0,8	BCPR6ES	96990	BCP6ES	94000

HYUNDAI



CAR • SUV • LCV



Model	Type	Capacity	Year	Cyl	Engine	Gap	Recommended	Stock Code	Alternative	Stock Code
-------	------	----------	------	-----	--------	-----	-------------	------------	-------------	------------

HYUNDAI

HYUNDAI

MATRIX	1.8 I	1800	2004->	4	G4GB	1,1	BKR5E-11	93674		
S COUPE	1.5 GT TURBO	1500	1994->1995	4	G4EK	0,8	BKR6E	97737		
S COUPE	1.5 LS	1500	1994->1995	4	G4EK	1,1	BKR5E-11	91130		
SANTA FE 2	2.4 I	2400	2010->	4	G4KC/ G4KE	1,1	LFR5A-11	95304		
SANTA FE 2	2.7 I	2700	2005->2009	6	G6BA/ G6EA	1,1	ILFR5B-11	1637	LFR5B	7113
SANTA FE 3	2.2 CRDI	2200	2012->	4	D4HB		Y-1003AS	92283		
SANTE FE	2.0 CRDI	2000	2001->2005	4	4DEA		Y-749J	5013		
SANTE FE	2.0 CRDI 4X4	2000	2005->	4	D4EA		Y-749J	5013		
SANTE FE	2.2 CRDI	2200	2006->	4	D4EB		Y-749J	5013		
SANTE FE	2.4 I	2400	2001->2005	4	G4JS-G	1,1	PGR5C-11	5760	BPR5E-11	4424
SANTE FE	2.7 I	2700	2001->2005	6	G6BA-G	1,1	IFR5N-10	7866	BKR5E-11	93674
SONATA	2.0 GL, GLS	2000	1996->2000	4	G4CP-U	0,8	BKR5E-11	91130		
SONATA	2.0 GL	2000	1993->1998	4	G4CS	1,1	BPR6E-11	94967		
SONATA	2.0 GL	2000	1998->2004	4	G4JP	1,1	BPR6E-11	94967		
SONATA	2.0 GL, GLS	2000	1994->1996	4	G4CP	0,8	BPR6E-11	94967		
SONATA	2.4 GL, GLS	2400	2006->	4	G4CS	1,1	ZFR5F-11	93814		
SONATA	2.4 I	2400	1989->	4	4G64	1,1	BPR6E-11	94967		
SONATA	2.4 I	2400	1989->2001	4	G4KC	1,1	BKR5E-11	91130		
SONATA	2.4 I	2400	2010->	4	G4KE	1,1	LFR5A-11	95304		
SONATA	2.4 L	2400	2008->	4	G4KC	1,1	LFR5A-11	95304		
SONATA	2.5 VIVANTE	2500	1999->	6	G6BVW	1	IFR5N-10	7866	BKR5E-11	93674
SONATA	2.7 V6	2700	2003->2005	6	G6BA-G	1,1	PFR6B-11	4014	BKR6E-11	94306
SONATA	3.0 GLS	3000	1994->	6	G6ATR	0,8	BPR6E	96989		
SONATA	3.3 V6	3300	2005->2008	6	G6DB	1,1	IFR5G-11	7854	BKR5E-11	93674
TERRACAN	2.9 CRDI	2900	2000->2005	4			CZ257	96868		
TERRACAN	3.5 V6	3500	2001->	6	G6CU	1,1	IFR5N-10	7866	BKR5E-11	93674
TIBURON	2.0 FL	2000	2006->	4	G52 L4D	1,1	IFR5E-11	7994	BKR5E-11	93674
TIBURON	2.0 FX	2000	1996->	4	J2	1,1	BKR5E-11	91130		
TIBURON	2.7 GT V6	2700	2006->	6	F FI	1,1	IFR5E-11	7994	BKR5E-11	93674
TIBURON	2.7 V6	2700	2004->	6	G6BA-G	1,1	PFR6B-11	4014	BKR6E-11	94306
TRAJET	2.0 CRDI	2000	2001->	4	4DEA		Y-749J	5013		
TRAJET	2.0 I	2000	2004->	4	G4JP-G	1,1	PFR6N-11	3546	BKR6E-11	94306
TRAJET	2.7 V6	2700	2004->	6	G6BA	1,1	IFR5N-10	7866	BKR5E-11	93674
TUCSON	2.0 16V	2000	2004->	4	G4GC	1,1	BKR5E-11	91130		
TUCSON	2.0 CRDI	2000	2004->	4			Y-749J	5013		
TUCSON	2.0 I	2000	2015->	4	G4NA	1,1	SILZKR7B-11	9723		
TUCSON	2.0 I	2000	2015->	4	G4NC	1,1	SILZKR7B-11	9723		
TUCSON	2.7 GLS V6	2700	2006->	6	D-FI	1,1	IFR5E-11	7994	BKR5E-11	93674
TUCSON	2.7 V6	2700	2004->	6	G6BA	1,1	IFR5N-10	7866	BKR5E-11	93674
TUCSON	3.0 V6	3000	2001->	6	XG300	1,1	PFR5J-11	4642	BKR5E-11	93674
VELOSTER	1.6 CVVT	1600	2011->	4	G4FD	1	SILZKR6B-10E	93815		
VENUE	T-GDI	998	2018->		G3LC		ILKR9G8	97168		

INFINITI

INFINITI

EX	3.7 I	3700	2012->	6	VQ37VHR	1,1	DF8H-11B	1305		
FX	3.7 I	3700	2012->	6	VQ37VHR	1,1	DF8H-11B	1305		
FX	5.0 V8	5000	2012->	8	VK50VE	1,1	DILKAR7B-11	1406		
G37	3.7 GT CABRIO	3700	2012->	6	VQ37VHR	1,1	DF8H-11B	1305		
M	3.0 D	3000	2012->	6	V9X		CZ303	9970		
M37	3.7 GT	3700	2012->	6	VQ37VHR	1,1	DF8H-11B	1305		
Q50	2.0 T	2000	2014->	4		0,7	SILZKFR8E7S	90654		
Q50	2.0 T	2000	2015->	4		0,7	SILZKFR8E7S	90654		
Q50S	3.5 HYBRID	3500	2013->	6	VG35HR	1,1	DF7H-11B	1317		
Q60	3.7 GT	3700	2013->	6	VQ37VHR	1,1	DF8H-11B	1305		
Q70	3.7 GT	3700	2013->	6	VQ37VHR	1,1	DF8H-11B	1305		
QX50	3.7 GT	3700	2013->	6	VQ37VHR	1,1	DF8H-11B	1305		
QX70	3.7 GT	3700	2013->	6	VQ37VHR	1,1	DF8H-11B	1305		
QX70	5.0 S	5000	2013->	8	VK50VE	1,1	DF7H-11B	1317		

INTERSTATE (TRAX)

INTERSTATE (TRAX)

DATSUN	2.8 L	2800	1992->	6	L28	0,8	BPR6E	96989		
FORD	2.0 GS	2000	1991->	4	KOLN	0,8	A6FS	2210	AP6FS	2710
FORD	3.0 S	3000	1990->	6	ESSEX	0,8	BPR6E	96989		
GM	2.3 H	2300	1992->	4		0,8	BPR5E	94084		
GM	3.8 H	3800	1995->	6		0,8	BPR5E	94084		
GM	4.1 L	4100	1990->	6		0,8	BPR5E	94084		



CAR • SUV • LCV



Model	Type	Capacity	Year	Cyl	Engine	Gap	Recommended	Stock Code	Alternative	Stock Code
ISUZU										
FLEETSIDE	1.6 PICK-UP	1600	1987->1989	4	G161Z	0,8	BPR6ES	96989		
FRONTIER	320 V6	3200	1998->	6	6VD1	1,1	BKR6E-11	94306		
KB	160 FLEETSIDE	1600	1989->1995	4	4ZA1	0,8	BPR6ES	96989		
KB	180 FL	1800	1981->1989	4	4ZB1	0,8	BPR6ES	96989		
KB	200 FLEETSIDE	2000	1994->1996	4	4ZC1	0,8	BPR6ES	96989		
KB	200 I	2000	2007->	4	X20NE	1,1	BKR6E-11	94306		
KB	200 KBD 21,26, 41,42	2000	1981->1984	4	C190		Y-306R	6244		
KB	200 L	2000	1999->	4	C20NE	1,1	BPR6ES-11	94967		
KB	200 LH	2000	1978->1981	4	4ZC1	0,8	BPR6ES	96989		
KB	200 SX	2600	1981->1989	4	G200Z	0,8	BPR6ES	96989		
KB	220 D	2200	1986->1987	4	C223		Y-306R	6244		
KB	220 D	2200	1987->1988	4	C223		Y-710J	7880		
KB	220 I	2200	1999->	4	C22NE	0,8	BPR6ES	96989		
KB	220 I	2200	2003->	4	MPFI	0,8	BKR6EK	94007		
KB	220 KL	2200	1987->1989	4	4ZD1	0,8	BPR6ES	96989		
KB	220 SE	1600	1981->1989	4	4ZD1	0,8	BPR6ES	96989		
KB	220 TD	2200	1986->1987	4	C223		Y-306R	6244		
KB	220 TD	2200	1987->1988	4	C223		Y-710J	7880		
KB	230 H	2300	1989->1995	4	4ZD1	0,8	BPR6ES	96989		
KB	230 S	2300	1987->1989	4	4ZD1	0,8	BPR6ES	96989		
KB	240 I	2400	2004->	4	C24SE	0,8	BPR6ES	96989		
KB	240 I	2400	2007->	4	X24SE	1,1	BKR6E-11	94306		
KB	250 DT	2500	1998->	4	4JA1		Y-904M1	7995		
KB	250 S	1600	1978->1981	4	G161Z	0,8	BPR6ES	96989		
KB	260 I	2600	1992->1996	4	4ZE1	0,8	BPR6ES	96989		
KB	260 L	2600	1981->1989	4	4ZE1	0,8	BPR6ES	96989		
KB	270 LH	1600	1981-> 1989	4	G161Z	0,8	BPR6ES	96989		
KB	280 TD LE,LX	2800	1993->2001	4	4JB1		Y-904M1	7995		
KB	2.4 16V	2400	2012->	4	Z24SED	0,8	BKR6EKC	2848		
KB	2.5 D-MAX	2500	2010->	4	4JK1		Y-1001J1	93034		
KB	300 TDI	3000	2002->2008	4	4JH1		Y-904M1	7995		
KB	320 V6	3200	1998->	6	6VD1	1,1	BKR6E-11	94306		
KB	350 I	3500	2004->	6	6VE1	1,1	PFR5J-11	4642	BKR5E-11	93674
KB	360 L	3600	2007->2008	6	HF	1,1	PFR5J-11	4642	BKR5E-11	93674
KB	360 LX	3600	2009->	6	HF	1,3	PTR5A-13	2467	TR5B-13	97667
KB	3.0 D-MAX	3000	2010->	4	4JJ1		Y-1001J1	93034		
RELAY	1.8 VAN	1800	>1993	4	4ZB1	1,1	BPR5ES-11	4424		
RELAY	2.0 VAN	2000	1986->	4	4ZC1	1,1	BPR5ES-11	4424		
TROOPER	1.6	1600	1988->	4	4ZA1	0,8	BPR6ES	96989		
TROOPER	220 D	2200	1981->1987	4	C223		Y-306R	6244		
TROOPER	220 D,TD	2200	1987->1988	4	C223,T		Y-710J	7880		
TROOPER	220 TD	2200	1981->1987	4	C223T		Y-306R	6244		
TROOPER	220 UBS 4X4	2200	1981->	4	C223, C223T		Y-104	6425		
TROOPER	280 TD	2800	1988->1991	4	4JB1TC		Y-904M1	7995		
TROOPER	2.0 TFR 12	2000	>1993	4	4ZC1	1,1	BPR5ES-11	4424		
TROOPER	2.3	2300	1988->	4	4ZD1	0,8	BPR6ES	96989		
TROOPER	2.6 E	2600	1989->	4	4ZE1	1,1	BPR6ES-11	94967		
TROOPER	2.6 L	2600	1989->	4	4ZE1	1,1	BPR6ES-11	94967		
TROOPER	300 DTI	3000	1998->	4	4JX1		Y-711J	5264		
TROOPER	320 LE	3200	1998->	6	6VD1	1,1	BKR6E-11	94306		
TROOPER	3.0 TD	3000	1992->	6	4JG2		Y-719RS1	6900		

JAGUAR										
E-TYPE	5.3 FIV12	5300	1971->1975	12		0,8	BPR5ES	94084		
EXECUTIVE	4.2 SERIES II	4200	1974->1980	6	XJ-6	0,8	BPR5ES	94084		
F-PACE	F-PACE	2995	2016->	6	306PS	1	SILZKAR7E8S	93476		
F-TYPE	3.0 S	3000	2013->	6		1	SILZKAR7E8S	93476		
F-TYPE	3.0 V6	3000	2013->	6		1	SILZKAR7E8S	93476		
F-TYPE	5.0 V8S	5000	2012->	8	AJ-V8	1	ILKAR7C-10	94940		
S	MK2	16	1959->1968	6	L6	0,5	B6ES	7310	BP6ES	91076
S-TYPE	3.0 I V6	3000	1998->2003	6	AJ-6	1,3	PTR6D-13	5598	BPR6EFS-15	4871
S-TYPE	4.0 I V8	4000	2000->	8	AJ-8	1,1	PFR5J-11	4642	BKR5E-11	93674
S-TYPE	4.2 I V8	4200	2003->	8	AJ-8	1	IFR5N-10	7866	BKR5E-11	93674
S-TYPE	4.2 I V8	4200	2007->	8	FI	1	IFR5N-10	7866	BKR5E-11	93674
S-TYPE	4.2 R V8	4200	2002->	8	AJ-8	1	IFR5N-10	7866	BKR5E-11	93674
SOVEREIGN	4.0 L	4000	1989->	6	XJ-6	0,8	BCPR6ES	96990	BCP6ES	94000
X-TYPE	2.0 SI V6	2000	2001->	6	AJ-6	1,3	TR6AP-13E	4968		
X-TYPE	2.2 D	2200	2005->	4	LJ46G		YE08	4966		
X-TYPE	3.0 SI V6	3000	2005->	6	AJ-6	1,3	PTR6D-13	5598	BPR6EFS-15	4871
X-TYPE	3.0 V6	2967	2001->2008	6	AJ-V6	1,3	TR6AP-13			
XF	2.2 D	2200	2009->	4	BG		YE08	4966		



CAR • SUV • LCV



Model	Type	Capacity	Year	Cyl	Engine	Gap	Recommended	Stock Code	Alternative	Stock Code
JAGUAR										
XF	3.0 SI V6	3000	2008->	6	AJ-6	1,3	TR6AP-13E	4968		
XF	4.2 I	4200	2008->	8	AJ33	1	IFR5N-10	7866	BKR5E-11	93674
XFR	5.0 I	5000	2009->	8	AJ133	1	ILKAR7C-10	94940		
XFR	5.0 I SUPERCHARGED	5000	2009->	8	AJ-133	1	ILKAR7C-10	94940		
XJ	3.0 R-SPORT	3000	2012->	6	AJ126	0,8	SILZKAR7E8S	93476		
XJ	5.0 I	5000	2010->	8	AJ133	1	ILKAR7C-10	94940		
XJ-12	5.3 I V12	5300	1991->1993	12	HE-12	0,6	BR7EFS	1094		
XJ-12	6.0 I V12	6000	1994->1996	12	HE-12	0,6	BR7EFS	1094		
XJ-6	3.0 I	3000	2005->	6	AJ-6	1,3	PTR6D-13	5598	BPR6EFS-15	4871
XJ-6	3.6 I	3600	1987->1990	6	AJ-6	0,8	BCPR6ES	96990	BCP6ES	94000
XJ-6	4.0 I	4000	1990->1998	6	AJ-6	0,8	BCPR6ES	96990	BCP6ES	94000
XJ-6	4.2 SERIES 3	4200	1975->1977	6	XK	0,8	BPR5ES	94084		
XJ-8	3.5 S	3500	2003->	8	XJ-33	1	IFR5N-10	7866	BKR5E-11	93674
XJ-8	4.0 S	4000	1997->	8	AJ-V8	1,1	BCPR6EIX-11	4919		
XJ-8	4.2 R	4200	2002->	8	AJ-26	1	IFR5N-10	7866	BKR5E-11	93674
XJ-8	4.2 S	4200	2003->2007	8	AJ-33	1	IFR5N-10	7866	BKR5E-11	93674
XJR	4.0 SUPERCHARGED	4000	1994->1997	8	AJ-16	0,8	BCPR7E	1272		
XJR	4.0 SUPERCHARGED	4000	1997->2000	8	AJ-26	1,3	PFR6G-13E	2341		
XJR	4.0 SX	4000	1986->1991	6	AJ-6	0,8	BCPR6ES	96990	BCP6ES	94000
XJR	4.2 L	4200	2004->	8	AJ-33	1	IFR5N-10	7866	BKR5E-11	93674
XJS	5.3 COUPE V12	5300	1982->1985	12	HE-12	0,8	BPR6EFS	92170		
XJS	5.3 V12	5300	1982->1985	12	HE-12	0,8	BP6EFS	93834	BPR6EFS	92170
XJS	5.3 V12	5300	1986->	12	HE-12	0,6	BR7EFS	1094		
XK	4.2 V8	4200	2005->	8	AJ-8	1	IFR5N-10	7866	BKR5E-11	93674
XK	5.0	5000	2011->2014	8	508PS	1	ILKAR7C-10	94940		
XK8	4.0 V8	4000	2002->	8	AJ-26, 27	1	IFR5N-10	7866	BKR5E-11	93674
XK8	4.2 SI	4200	2002->	8	AJ-34	1	IFR5N-10	7866	BKR5E-11	93674
XKR-S	5.0 I	5000	2011->	8	AJ133	1	ILKAR7C-10	94940		
XKR/ YK8	4.2 V8	4200	2002->2006	8	AJ-34	1	IFR5N-10	7866	BKR5E-11	93674

JAGUAR

JEEP										
Model	Type	Capacity	Year	Cyl	Engine	Gap	Recommended	Stock Code	Alternative	Stock Code
GRAND JEEP CHEROKEE	2.5 D	2500	1997->1999	4	VM		Y-741U	5065		
GRAND JEEP CHEROKEE	2.5 TD	2500	1999->	4	ENC		Y-741U	5065		
GRAND JEEP CHEROKEE	2.7 CRD	2700	2002->	5	MERCEDES CDI		Y-745U	4705		
GRAND JEEP CHEROKEE	3.0 CRD	3000	2006->2010	6	MERCEDES		Y-745U	4705		
GRAND JEEP CHEROKEE	3.0 CRD	3000	2012->	6	EXL		Y8002AS	6286		
GRAND JEEP CHEROKEE	3.0 CRDI V6	3000	2011->	6	EXF		Y-9003AS	95836		
GRAND JEEP CHEROKEE	3.6 I	3600	2011->	6		0,8	ILKR7B-8	1989		
GRAND JEEP CHEROKEE	3.7 I V6	3700	2006->	6	KFI	1,1	PZFR6F-11	3271	ZFR6F-11	93208
GRAND JEEP CHEROKEE	3.7 V6 LAREDO	3700	2009->	6	KFI	1,1	PZFR6F-11	3271	ZFR6F-11	93208
GRAND JEEP CHEROKEE	4.0 I	4000	2003->2004	6	L6 SFI	0,8	ZFR5N	7917		
GRAND JEEP CHEROKEE	4.7 I	4700	1999->	8		1,1	BKR5E-11	93674		
GRAND JEEP CHEROKEE	4.7 I V8	4700	2000->2004	8	N FI SOHC	1,1	PZFR6F-11	3271	ZFR6F-11	93208
GRAND JEEP CHEROKEE	4.7 V8 LAREDO	4700	2006->	8	N FI	1,1	PZFR6F-11	3271	ZFR6F-11	93208
GRAND JEEP CHEROKEE	5.2 I	5200	2001->	8		1,1	ZFR5F-11	93814		
GRAND JEEP CHEROKEE	5.7 L	5700	2011->	8		1,1	LZFR5C-11	92633		
GRAND JEEP CHEROKEE	5.7 V8 OVERLAND	5700	2006->	8	2FI	1,1	LZTR5AIX-13	2314		
GRAND JEEP CHEROKEE	5.7 V8 OVERLAND	5700	2009->	8	2FI	1,1	LZFR5C-11	92633		
GRAND JEEP CHEROKEE	5.9 I	5900	2001->	8		1,1	ZFR5F-11	93814		
GRAND JEEP CHEROKEE	6.1 V8 SRT8	6100	2006->2009	8	3FI	1,3	LZTR5AIX-13	2314		
GRAND JEEP CHEROKEE	6.4 SRT8	6400	2012->	8		1,1	LZTR6AP11EG	97408	LZTR5AIX-13	2314
GRAND JEEP CHEROKEE III	6.1 SRT8 4X4	6100	2006->2010	8	STR-8	1,3	PLZTR5A-13	4998	LZTR5AIX-13	2314
JEEP	3.1 I	3100	1998->	5	EXA		Y-741U	5065		
JEEP	CJ5 1.9 L	1900	1985->	4	VW	0,8	BPR6ES	96989		
JEEP CHEROKEE	2.4 CHEROKEE	2400	2003->	4		1,1	LZTR4A-11	5444		
JEEP CHEROKEE	2.4 L	2400	2012->	4	ECN	1,1	ZFR5F-11	93814		
JEEP CHEROKEE	2.5 CHEROKEE	2500	1999->	4	VM HR425		Y-741U	5065		
JEEP CHEROKEE	2.5 CHEROKEE	2500	2001->	4			Y-745U	4705		
JEEP CHEROKEE	2.5 D	2500	1995->2001	4	VM		Y-741U	5065		
JEEP CHEROKEE	2.8 CRD	2800	2004->2008	4	ENR		Y-1031J	96289		
JEEP CHEROKEE	2.8 TD	2800	2004->	4	KJ		Y-745U	4705		
JEEP CHEROKEE	3.2 L	3200	2012->	6	EHB	1,3	LZTR5AIX-13	2314		
JEEP CHEROKEE	3.7 CHEROKEE	3700	2001->	6		1,1	PZFR6F-11	3271	ZFR6F-11	93208
JEEP CHEROKEE	3.7 V6 SPORT	3700	2001->	6		1,1	ZFR6F-11	93208		
JEEP CHEROKEE	4.0 CHEROKEE	4000	1996->	6	L6	1,1	ZFR5F-11	93814		
JEEP CHEROKEE	4.0 I V6	4000	2001->	6		1	FR5-1	7252		
JEEP CHEROKEE	4.7 I V8	4700	2001->	8		1,1	BKR5E-11	93674		
JEEP COMMANDER	3.0 CRD	3000	2006->2010	6	EXL		Y8002AS	6286		
JEEP COMMANDER	3.0 CRD COMMANDER	3000	2006->	6			Y-745U	4705		
JEEP COMMANDER	3.7 COMMANDER	3700	2006->	6	V6 KFI	1,1	PZFR6F-11	3271	ZFR6F-11	93208
JEEP COMMANDER	4.7 V8 LTD COMMANDER	4700	2006->	8	NFI	1,1	PZFR6F-11	3271	ZFR6F-11	93208



CAR • SUV • LCV



Model	Type	Capacity	Year	Cyl	Engine	Gap	Recommended	Stock Code	Alternative	Stock Code
JEEP										
JEEP COMMANDER	5.7 V8 COMMANDER	5700	2006->	8	2FI	1,1	LZTR5AIX-13	2314		JEEP
JEEP COMPASS	2.0 CRD COMPASS	2000	2006->	4			CZ304	9835		
JEEP COMPASS	2.0 L	2000	2012->	4	ECN	1,1	ZFR5F-11	93814		
JEEP COMPASS	2.0 LIMITED CRD	2000	2006->	4			CZ304	9835		
JEEP GRAND CHEROKEE	5.2 V8 GRAND CHEROKEE	5200	1996->	8		0,8	BCPR6ET	2197		
JEEP LIBERTY	2.4 LIBERTY	2400	2005->	4		1,1	LZTR4A-11	5444		
JEEP PATRIOT	2.4 LIMITED	2400	2007->	4		1,1	ZFR5F-11	93814		
JEEP RENEGADE	1.4 T-JET	1400	2015->	4	EAM	0,8	IKR9J8	93311		
JEEP RENEGADE	1.4 T-JET LTD	1400	2015->	4	EAM	0,8	IKR9J8	93311		
JEEP RENEGADE	1.6 E-TORQ	1600	2014->	4	EJH	0,8	IKR7D	4759	DCPR7EA-9	6651
JEEP RENEGADE	EJH	1598	2015->	4			IKR7D	4759	DCPR7EA-9	6651
JEEP WRANGLER	2.4 I	2400	2006->	4	L4 1FI	1,1	LZTR5AIX-13	2314		
JEEP WRANGLER	2.5	2464	1997->		EPE	1	FR5-1	7252		
JEEP WRANGLER	2.5 I	2500	2001->	4	EPE	1	FR5-1	7252		
JEEP WRANGLER	2.8 CRDI	2800	2011->	4			Y8011AS	90403		
JEEP WRANGLER	3.6 I	3600	2012->	6	ERB	0,8	ILZKR7B-11S	5787		
JEEP WRANGLER	3.6 I WRANGLER	3600	2012->	6	ERB	0,8	ILKR7B-8	1989		
JEEP WRANGLER	3.8 V6 RUBICON	3800	2007->	6	FI	1,3	LZTR5AIX-13	2314		
JEEP WRANGLER	4.0 I	4000	2001->	6	ERH	1	FR5-1	7252		
JEEP WRANGLER	4.0 RUBICON	4000	2006->	6	L6 SFI	0,8	ZFR5N	7917		
JEEP WRANGLER	4.0 SPORT	4000	2006->	6	L6 SFI	0,8	ZFR5N	7917		

KIA										
CARENS	1.8 I LS	1800	2000->2002	4	T8	1,1	BKR6E-11	94306		
CARENS	2.0 CRDI EX	2000	2003->	4	D4EA		Y-749J	5013		
CARENS	2.0 I	2000	2004->	4	G4GC	1,1	BKR5ES-11	91130		
CARENS 3	2.0 I	2000	2007->	4	G4KA	1,1	BKR5ES-11	91130		
CARNIVAL	2.2 CRDI	2200	2010->	4	D4HB		CZ105	90007		
CARNIVAL	2.5 L	2500	1999->	6	KV6	1,1	PFR6N-11	3546	BKR6E-11	94306
CARNIVAL	2.9 CRDI	2900	2006->	4	J3		Y-535J	91416		
CEE'D	1.4 I	1400	2007->	4	G4FA	1,1	ZFR5F-11	93814		
CEE'D	1.6 I	1600	2007->	4	G4FC	1,1	ZFR5F-11	93814		
CEE'D	2.0 CRDI	2000	2008->	4	D4EA-F		Y-748U	5000		
CEE'D	2.0 I	2000	2007->	4	G4GC	0,8	BKR5ES	90841		
CERATO	1.6 EX	1600	2010->	4	G4FC	1	LZKR6B-10E	1578		
CERATO	1.6 I	1600	2006->2009	4	G4FC	1,1	ZFR5F-11	93814		
CERATO	1.6 I	1600	2013->	4	G4FC	0,8	SILZKR6D8E	91568		
CERATO	1.6 I	1600	2009->2012	4	G4FC	1,1	ZFR5F-11	93814		
CERATO	1.6 L	1600	2004->	4	G4ED	0,8	BCPR6ES	96990	BCP6ES	94000
CERATO	2.0 16V	2000	2009->2013	4	G4KD	1,1	LFRA5A-11	95304		
CERATO	2.0 16V	2000	2014->	4	G4KD	1,1	SILZKR7B-11	9723		
CERATO	2.0 KOUP	2000	2010->	4	G4GC	1,1	BKR5ES-11	91130		
CERATO	2.0 L	2000	2004->	4	G4GC	1,1	BKR5ES-11	91130		
CLARUS	2.0 GLX	2000	1998->	4	FE DOHC	1,1	BKR6E-11	94306		
K2500	2.5 TDCI	2500	2002->2003	4	69		CZ257	96868		
K2700	2.7 TD	2700	1990->1999	4	VN		Y-701J	5116		
KOUP	1.6 TGD I	1600	2013->2017	4	G4FJ	0,8	SILZKR6D8E	91568		
KOUP	2.0 EFI	2000	2010->	4	G4KD	1,1	LFRA5A-11	4775	LFRA5A-11	95304
KOUP	2.0 SI	2000	2013->2017	4	G4NC	1,1	SILZKR7B-11	9723		
MAGENTIS	2.0 I	2000	2004->	4	G4KA	0,8	BPR6ES	96989		
MAGENTIS	2.5 I	2500	2003->	6	G6BV	0,8	BKR5ES	90841		
MAGENTIS	2.5 I	2500	2004->	6	KV6	1,1	PFR6N-11	3546	BKR6E-11	94306
MAGENTIS	2.7 I	2700	2006->	6	G6EA	1,1	ILFR5B-11	1637	LFRA5B	7113
OPTIMA	2.4	2359	2011->2015	4	G4KC	1,1	SILZKR7B-11	9723		
OPTIMA	2.4 I	2400	2012->	4	G4KD	1,1	SILZKR7B-11	9723		
PICANTO	1.0 I	1000	2004->	4	G4HE	1,1	BKR6ES-11	94437		
PICANTO	1.0 MPI	1000	2010->	3	G3LA	1	LKR6D-10E	96569		
PICANTO	1.1 LX	1100	2004->	4	G4HG	1,1	BKR5ES-11	91130		
PICANTO	1.2 I	1200	2011->	4	G4LA	1	SILKR6C10E	97098		
PICANTO 2	1.0 I	1000	2011->	3	G3LA	1	LKR6D-10E	96569		
PICANTO 2	1.2 I	1200	2011->	4	G4LA	1	SILKR6C10E	97098	LKR6D-10E	96569
PREGIO	2.5 TDCI	2500	2001->2006	4	D4BH		CZ257	96868		
PREGIO	2.7 D SEAT	2700	1996->2004	4	J2		Y-701J	5116		
PREGIO	3.0 D	3000	2003->	6	W3,NB9		Y-701J	5116		
PRIDE	1.3 LX	1300	1998->	4	B3	1,1	BPR5ES-11	4424		
PRIDE	1.6 CVVT	1600	2005->	4		1,1	PFR5N-11	5838	BKR5E-11	93674
PRO-CEED	2.0 FI	2000	2007->	4	G4GC	1,1	BKR5ES-11	91130		
RIO	1.2 I	1200	2012->	4	G4LA	1	LKR6D-10E	96569		
RIO	1.3 RS	1300	2001->	4	A2E	0,8	BPR5EY	94270		
RIO	1.4 CVVT	1400	2011->	4	G4FA	1	LZKR6B-10E	1578		
RIO	1.4 CVVT	1400	2017->	4	G4LC	1	SILKR6C10E	97098		



CAR • SUV • LCV



Model	Type	Capacity	Year	Cyl	Engine	Gap	Recommended	Stock Code	Alternative	Stock Code
KIA										
RIO	1.4 HATCH	1400	2005->	4	G4EE	1,1	BKR5ES-11	91130		
RIO	1.4 L	1400	2001->	4	A3E	0,8	BPR5EY	94270		
RIO	1.4 S	1400	2005->	4	G4EE	1,1	BKR5ES-11	91130		
RIO	1.5 CRDI	1500	2004->	4	D4FA		Y-527J	91843		
RIO	1.5 RS	1500	2001->	4	A5D	0,8	BPR5EY	94270		
RIO	1.6 L	1600	2006->2010	4	L4 FI	1,1	BKR5ES-11	91130		
RIO	1.6 LX	1600	2010->	4	L4	1,1	BKR5ES-11	91130		
SEDONA	2.2 CRDI	2200	2010->	4	D4HB		CZ105	90007		
SEDONA	2.5 V6	2500	2004->	6	KV6	1,1	PFR6N-11	3546	BKR6E-11	94306
SEDONA	2.9 D	2900	2006->	4	CRDI		Y-535J	91416		
SEDONA	3.8 V6	3800	2010->	6		1,1	IFR5G-11	7854	BKR5E-11	93674
SELTOS	1.6 MPI	1591	2019->	4	G4FG		IFR5L11			
SEPHIA	1.5 I LS,RS	1500	1998->2000	4	B5E	1,1	BKR6E-11	94306		
SHUMA	1.5 I LS	1500	1999->	4	B5, BFD	1,1	BKR6E-11	94306		
SHUMA	1.8 I GS	1800	1999->	4	TED	1,1	BKR6E-11	94306		
SHUMA 2	1.6 FI	1600	2002->	4	OKAB5	0,8	BKR6E	97737		
SHUMA 2	1.8 FI	1800	2002->	4	T8D	0,8	BKR6E	97737		
SORENTO	2.2 CRDI	2200	2009->	4	D4HA		Y-1003AS	92283		
SORENTO	2.4 I	2400	2010->	4	G4KE	1,1	LFRA5A-11	95304		
SORENTO	2.5 CRDI	2500	2004->	4	G4JS		Y-508J	3709		
SORENTO	2.5 CRDI	2500	2009->	4	D4CB		Y-508J	3709		
SORENTO	3.5	3470	2009->2015	6	G6DC		PFR5N-11	5838	BKR5E-11	93674
SORENTO	3.5 V6	3500	2003->	6	G6CU	1,1	IFR5N-10	7866	BKR5E-11	93674
SORENTO	3.8 I V6	3800	2006->	6	G6DA	1,1	IFR5G-11	7854	BKR5E-11	93674
SOUL	1.6 CRDI	1600	2009->	4	D4FB		Y-527J	91843		
SOUL	1.6 I	1600	2009->	4	G4FC	1	LZKR6B-10E	1578		
SOUL	1.6 I	1600	2009->	4	G4FC	1,1	ZFR5F-11	93814		
SOUL	2.0 I	2000	2009->	4	L4	1,1	ZFR5F-11	93814		
SOUL	2.0 I	2000	2013->	4	G4KD	1,1	SILZKR7B-11	9723		
SPECTRA	1.6 LS	1600	2002->	4		0,8	BKR6E	97737		
SPORTAGE	2.0 CDRI	2000	2006->	4	D4EA		Y-749J	5013		
SPORTAGE	2.0 CRDI	2000	2010->	4	D4HA		Y-1003AS	92283		
SPORTAGE	2.0 CVVT	2000	2011->	4	G4KD	1,1	LFRA5A-11	95304		
SPORTAGE	2.0 CVVT	2000	2015->	4	G4NA	1,1	SILZKR7B-11	9723		
SPORTAGE	2.0 I	2000	1998->	4	NB7	1,1	BKR6E-11	94306		
SPORTAGE	2.0 I	2000	2006->	4	G4GC	1,1	BKR6ES-11	94437		
SPORTAGE	2.0 LX	2000	2010->	4	G4KD	1,1	LFRA5A-11	95304		
SPORTAGE	2.4 I	2400	2011->	4	G4KE	1,1	LFRA5A-11	95304		
SPORTAGE	2.7 V6	2700	2010->	6	G6BA	1,1	IFR5N-10	7866		
SUPER	3.0 TITAN	3000		6	E-3000		Y-107T	1253		
TITAN	2.5 D	2500		4	E-2500		Y-107T	1253		
LADA										
NIVA	1.7 I	1700	1998->	4	BA3-21214	1,1	BPR6ES-11	94967		
NIVA	1.8 I	1800	1995->	4	BA3-2130	0,8	BPR6ES	96989		
LAMBORGHINI										
GALLARDO	5.0 COUPE	5000	2005->	10	L140	1,1	PFR7G-11	2380	BCPR7ES	93606
GALLARDO	5.0 COUPE SUPERLEGGERA	5000	2007->	10	L140	1,1	PFR7G-11	2380	BCPR7ES	93606
GALLARDO	5.0 SPYDER	5000	2005->	10	L140	1,1	PFR7G-11	2380	BCPR7ES	93606
JALPA	3.5 L	3500	1985->1989	8		0,8	BR8EIX	5044		
MURCIELAGO	LP640	6500	2007->	12	L537	0,8	KR8DI	4742	DCPR8E	4339
LANCIA										
BETA	2.0 COUPE	2000	1976->1984	4	828CB1A	0,8	BPR7ES	95164		
DELTA HF	2.0 INTEGRALE EVO.	2000	1989->	4		0,8	BPR8ES	3923		
KAPPA	2.0 16V TURBO	2000	1997->2001	4	838 A4000	0,8	BP6ET	90921	BP6ES	91076
KAPPA	3.0 V6 24V	3000	1997->	4	838 B000	0,8	PFR6B	3500	BKR6E	97737
THEMA	2.0 IE 16V	2000	1987->1993	4	834 C1246	0,8	BP6ET	90921	BP6ES	91076
THEMA	2.0 IE T 16V	2000	1992->	4	834 F2000	0,8	BP6ET	90921	BP6ES	91076
THEMA	2.8 V6	2800	1987->1990	6	834 E000	0,8	BP6EFS	93834	BPR6EFS	92170
THEMA	3.0 32V	3000	1987->	8	F105L	0,9	DPR8EA-9	4929		
130	2.4 D	2400	2010->	4			Y-548J	96037		

KIA



CAR • SUV • LCV



Model	Type	Capacity	Year	Cyl	Engine	Gap	Recommended	Stock Code	Alternative	Stock Code
LAND ROVER										
90,11	90, 110 TD	2500	1983->	4			Y-208T	1250	LAND ROVER	
DEFENDER	2.4 D	2400	2008->	4			Y-548J	96037		
DEFENDER	2.5 I	2500	1990->	6		0,8	BPR6ES	96989		
DEFENDER	2.5 TDI	2500	1999->2007	4			Y-605J	4309		
DEFENDER	2.8 I	2800	1997->	6	M52	0,8	BKR6EK	94007		
DEFENDER	3.5 I	3500	1990->	8		0,8	BPR5ES	94084		
DISCOVERY	2.0 I	2000	1993->	4		0,8	BKR6E	97737		
DISCOVERY	2.5 TD5	2500	1999->	5			Y-924J	3473		
DISCOVERY	2.5 TD5	2500	1999->2004	5	136BHP		Y-605J	4309		
DISCOVERY	3.5 I V8	3500	1990->	8		0,8	BPR6ES	96989		
DISCOVERY	3.9 V8	3900	1991->1993	8		0,8	BPR5ES	94084		
DISCOVERY	3.9 I	3900	1994->1999	8		0,8	BKR6E	97737		
DISCOVERY	3.9 I	3900	1999->2000	8		1,1	PFR6N-11	3546	BKR6E-11	94306
DISCOVERY	3.9 I V8	3900	1994->	8		0,8	BPR6ES	96989		
DISCOVERY	4.0 I	4000	2002->	8		1,1	PFR6N-11	3546	BKR6E-11	94306
DISCOVERY 3	2.7 TD	2700	2004->	5	TDV6		YE 12	7794		
DISCOVERY 3	4.0 I	4000	2003->	6	V6 EFI	1,5	TR55IX	7164	TR6IX	3689
DISCOVERY 3	4.0 I	4000	2006->	8		1,5	TR55IX	7164	TR6IX	3689
DISCOVERY 3	4.4 I	4400	2004->2008	8		1	IFR5N-10	7866	BKR5E-11	93674
DISCOVERY 4	5.0 I	5000	2011->	8	AJ133	1	ILKAR7C-10	94940		
DISCOVERY SPORT	2.0 TD4	2000	2015->	4	204TD		CZ552	92738		
DISCOVERY SPORT	SPORT Si6	2995	2017->	6	306PS		SILKAR7E8S			
EVOQUE	2.0 Si4	2000	2011->	4	204PT	0,8	ILTR6G-8G	96621		
EVOQUE	2.0 TD4	2000	2015->	4	AJ200D		CZ552	92738		
EVOQUE	2.2 SD4	2200	2011->	4			YE08	4966		
FREELANDER	1.8 I	1800	1998->	4		1,1	PFR6N-11	3546	BKR6E-11	94306
FREELANDER	2.0 I	2000	2001->2001	6	KV6	1,1	PFR6N-11	3546	BKR6E-11	94306
FREELANDER	2.0 TD4	2000	1998->	4	M47D20 BMW		Y-507J	6897		
FREELANDER	2.0 TDI	2000	1997->1998	4	20 T2R		Y-730U	2273		
FREELANDER	2.5 TDI	2500	1998->	5			Y-924J	3473		
FREELANDER	2.5 V6	3000	2000->	6		1,1	PFR6G-11	5555	BKR6E-11	94306
FREELANDER 2	2.0 Si4	2000	2011->	4	204PT	0,8	ILTR6G-8G	96621		
FREELANDER 2	2.2 TD4	2200	2010->	4	DW12BTED4		YE08	4966		
FREELANDER 2	3.2 V6	3200	2006->	6		0,8	ILFR6B	6481	LF6B	6677
PICK-UP	2.2 88 SWB	2200	1986->	4		0,8	BPR5ES	94084		
PICK-UP	2.5 HARD TOP	2500	1986->1987	4		0,8	BPR6ES	96989		
PICK-UP	2.6 111 SERIES	2600	1996->	6	R6	0,8	BPR6ES	96989		
PICK-UP	2.6 V6 109 LWB	2600	1992->	6		0,8	BPR6ES	96989		
PICK-UP	3.5 V8 HI-LINE SWB	3500	1990->	8		0,8	BPR5ES	94084		
PICK-UP	3.5 V8 127 C/CAB	3500	1998->	8		0,8	BPR5ES	94084		
PICK-UP	3.5 V8 88 SWB	3500	1995->1996	8		0,8	BPR5ES	94084		
PICK-UP	3.5 V8 HARD TOP	3500	1992->	8		0,8	BPR5ES	94084		
PICK-UP	3.5 V8110 LWB	3500	1996->1998	8		0,8	BPR5ES	94084		
RANGE ROVER	2.5 TDI	2500	1994->	6	M51 D25 BMW		Y-924J	3473		
RANGE ROVER	2.5 VOGUE TD	2500	1990->1994	4	VM 425 SLIRR		Y-924J	3473		
RANGE ROVER	2.5 VOGUE TD	2500	1990->1994	4	VM HR-492		Y-924J	3473		
RANGE ROVER	3.5 V8	3500	1992->1994	8		0,8	BPR5ES	94084		
RANGE ROVER	3.9 SE V8	3900	1996->1998	8		0,8	BPR5ES	94084		
RANGE ROVER	3.9 VOGUE V8	3900	1994->1996	8		0,8	BPR5ES	94084		
RANGE ROVER	4.0 I	4000	1999->2002	8		1,1	PFR6N-11	3546	BKR6E-11	94306
RANGE ROVER	4.2 I V8	4200	1992->1994	8		0,8	BPR6ES	96989		
RANGE ROVER	4.4 I	4400	2002->	8	M62 BMW	0,8	BKR6EQUP	3199	BKR6EQUA	6872
RANGE ROVER	4.6 I	4600	1999->	8		1,1	PFR6N-11	3546	BKR6E-11	94306
RANGE ROVER 3	3.0 TD6	3000	2002->	6	M57 D30 BMW		Y-507J	6897		
RANGE ROVER 4	4.2 I	4200	2005->	8	AJ41	1	IFR5N-10	7866	BKR5E-11	93674
RANGE ROVER 4	4.4 I	4400	2005->	8	AJ41	1	IFR5N-10	7866	BKR5E-11	93674
RANGE ROVER 4	5.0 SPORT V8	5000	2009->	8	AJ133	1	ILKAR7C-10	94940		
LEXUS										
CT200	CT200H 1.8 HYB	1800	2011->	4	2ZRFXE	1,1	ILKAR7B-11	4912	LKAR7B-11	4801
ES250	2.5 I	2500	2012->	4	2AR-FE	1,1	ILFR6T-11	4904	LF6C-11	96098
ES250	ES250	2494	2014->2018	4	2AR-FE	1,1	ILFR6T-11	4904	LF6C-11	96098
ES300	3.0 I	3000	2000->2003	6	2JZ-GE	1,1	BKR6EKP-11	3452	BKR6EK	94007
ES300	3.0 I	3000	2004->	6	1MZ-FE	1,1	IFR6T-11	4589	BKR6EYA-11	91206
GS250	2.5 EX	2500	2012->	6	4GR-FSE	1,1	DFH6B-11A	6858		
GS300	3.0 I	3000	1993->1999	6	2JZ-GE	1,1	BKR5EP-11	3440	BKR5E-11	93674
GS300	3.0 I	3000	2002->	6	2JZ-GE	1,1	BKR6EKP-11	3452	BKR6EK	94007
GS300	3.0 I	3000	2005->	6	3GR-FSE	1,1	LF6C-11	96098	ILFR6T-11	4904
GS350	3.5 I	3500	2011->	6	2GRFSE	1,1	DFH6B-11A	6858		
GS430	4.3 I	4300	2007->	8	3UZ-FE	1,1	IFR6T-11	4589	BKR6EYA-11	91206
GS450H	3.5 V6, ELECTRIC	3500	2010->	6	2GR-FSE	1,1	DFH6B-11A	6858		



CAR • SUV • LCV

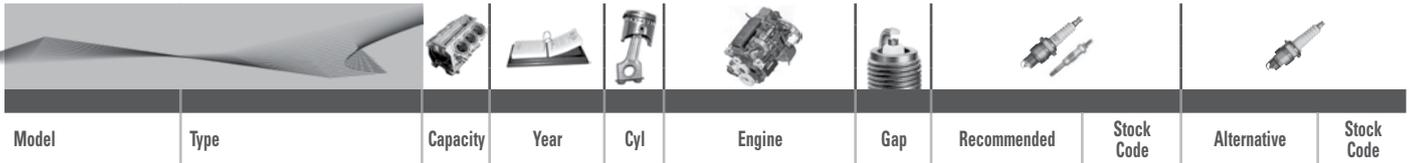

Model	Type	Capacity	Year	Cyl	Engine	Gap	Recommended	Stock Code	Alternative	Stock Code
LEXUS										
IS F	5.0 I	5000	2010->	8	2UR-GSE	1,1	DFH6B-11A	6858		
IS200	200T	2000	2015->	4	8AR-FTS	0,9	DILFR7K9G	91961		
IS200	2.0 I	2000	1998->	6	1G-FE	1,1	IFR6T-11	4589	BKR6EYA-11	91206
IS200	IS200T	1998	2017->	4	8AR-FTS	0,9	DILFR7K9G	91961		
IS250	2.5 I	2500	2006->	6	4GR-FSE	1	DFH6B-11A	6858		
IS300	3.0 I	3000	2002->	6	2JZ-GE	1,1	BKR6EKP8-11	3452	BKR6EK	94007
IS350	3.5 I	3500	2011->	6	2GR-FSE	1,1	DFH6B-11A	6858		
LC500	5.0 I	5000	2016->	8	2UR-GSE	1,1	DFH6B-11A	6858		
LS400	4.0 I	4000	1990->1997	8	1UAZ-FE	1,1	BKR5EP-11	3440	BKR5E-11	93674
LS400	4.0 I	4000	2000->	8	1UZ-FE	1,1	IFR6T-11	4589	BKR6EYA-11	91206
LS430	4.3 I	4300	2000->	8	3UZ-FE	1,1	IFR6T-11	4589	BKR6EYA-11	91206
LS460	4.6 I	4600	2006->	8	1UR-FE	1,1	LF6C-11	96098	ILFR6T-11	4904
LS460	4.6 I	4600	2006->2009	8	1UR-FSE	1	ILZKAR7A-10	6043	LZKAR7A	6799
LS460	4.6 I	4600	2010->	8	1UR-FSE	1,1	DFH6B-11A	6858		
LS600H	5.0 ELECTRIC, GAS	5000	2010->	8	2UR-SFE	1,1	DFH6B-11A	6858		
LX470	4.7 V8	4700	2000->	8	2UZ-FE TWC	1,1	IFR6T-11	4589	BKR6EYA-11	91206
LX570	5.7 V8	5700	2009->	8	3UR-FE FI	1,1	LF6C-11	96098	ILFR6T-11	4904
NX200	200 T	2000	2014->	4	8AR-FTS	0,9	DILFR7K9G	91961		
RC-F	3.5 I	3500	2015->	6	2UR-GSE	1,1	DFH6B-11A	6858		
RX300	3.0 V6	3000	2000->2006	6	1MZ-FE	1,1	IFR6T-11	4589	BKR6EYA-11	91206
RX300	3.3 V6	3300	2004->2006	6	3MZ-FE	1,1	IFR6T-11	4589	BKR6EYA-11	91206
RX330	3.0 V6	3000	2004->	6	1MZ-FE	1,1	IFR6T-11	4589	BKR6EYA-11	91206
RX330	3.3 V6	3300	2004->	6	3MZ-FE	1,1	IFR6T-11	4589	BKR6EYA-11	91206
RX350	3.5 V6	3500	2010->	6	2GR-FE	1,1	DILFR6D-11	6176	LF6D	4704
RX350	RX350 2GR	3456	2015->	6	2GR-FKZ	1,1	DILFR6D-11	6176	LF6D	4704
RX400H	3.3 V6	3300	2005->	6	3MZ-FE	1,1	IFR6T-11	4589	BKR6EYA-11	91206
RX450H	3.5 V6	3500	2010->	6	2GR-FXE	1,1	LF6AIX-11	6619	LF6A-11	3672
SC430	4.3 I	4300	2007->	8	3UZ-FE	1,1	IFR6T-11	4589	BKR6EYA-11	91206
LEYLAND										
MINI	1275 E	1300	1980->1984	4		0,8	BPR6ES	96989		
MINI	1275 MOKE	1275	1991->	4		0,8	BPR6ES	96989		
LOTUS										
ELAN SE	1.6 FI	1600	1990->	4		1,1	BKR6E-11	94306		
ELAN SE	1.6 TURBO	1600	1990->	4		0,8	BKR6E	97737		
ELISE	1.8 111S	1800	2005->	4	2ZZ-GE	1,1	IFR6T-11	4589	BKR6EYA-11	91206
ELISE	1.8 FI K SERIES	1800	2005->	4		1,1	PFR6N-11	3546	BKR6E-11	94306
ESPRIT	2.0 S3	2200	1985->	4	912	0,8	BPR6ES	96989		
ESPRIT	2.2 TURBO HC	2200	1986->	4	910	0,8	BPR6ES	96989		
ESPRIT	3.5 LX V8	3500	1996->	8	918	0,7	BKR6EK	94007		
EXCEL	2.2 S	2200	1983->	4	912	0,8	BPR6ES	96989		
EXCEL	2.2 SA, SE	2200	1986->	4	912S	0,8	BPR7ES	95164		
EXIGE	1.8 16V	1800	2001->	4		0,8	BCPR7E	1272		
EXIGE	1.8 16V SUPERCHARGED	1800	2006->	4		1,1	PFR7G-11	2380	BCPR7ES	93606
MACLAREN										
12C	3.8 BI TURBO	3800	2011->	8	MP4-12C	0,7	ILKAR8E7	90635		
MAHINDRA										
BOLERO	2.5 D	2500	2006->	4	DR54		Y-503J	5005		
BOLERO	2.6 TD	2600	2006->	4			Y-503J	5005		
SCORPIO	2.0 I	2000	2006->	4	F4R	1,1	PFR6G-11	5555	BKR6E-11	94306
SCORPIO	2.5 TD	2500	2006->	4	XD3P		Y-503J	5005		
SCORPIO	2.5 TD	2500	2010->	4			Y-8005J	94629		
MANDARIN										
SOYAT	2.0 I	2000	2007->	4	3Y	0,8	BPR5ES	94084		
MASERATI										
222	2.0 L	2000	1989->	4	AM 471	0,8	BPR7ES	95164		
222	2.8 IE COUPE	2800	1998->1992	6	V690 SOHC	0,7	DCPR7E	3932		
228	2.8 TURBO	2800	1988->1989	6	AM 473	0,8	BPR7ES	95164		
228	2.8 TURBO	2800	1990->	6		0,7	DCPR7E	3932		
422	2.0 I	2000	1988->	6	AM471	0,8	BPR7ES	95164		
425	2.5 I 18V V6	2500	1988->	6	DOHC	0,8	BPR8EIX	6684	BPR8ES	3923



CAR • SUV • LCV



Model	Type	Capacity	Year	Cyl	Engine	Gap	Recommended	Stock Code	Alternative	Stock Code
MASERATI										
430	2.8 LX	2800	1988->	6	AM473	0,8	BPR7ES	95164	MASERATI	
BI TURBO	2.5 SPYDER 8889 18V V6	2500	1988->	6	DOHC	0,8	BPR8EIX	6684	BPR8ES	3923
BI TURBO 11	2.5 COUPE 18V V6	2500	1988->	6	DOHC	0,8	BPR10EIX	95580	BPR8ES	3923
COUPE GT	4.2 GT	4200	2003->	8	F136R	0,7	PMR8B	6378	CPR8EA-9	2306
GHIBLI S	3.0 T	3000	2013->	6		0,6	ILKAR7L11	94124	SILKAR8C-6DG	94919
GHIBLI	2.0 SPORT	2000	1992->	6	AM496	0,8	DCPR9E	2641		
GRANSPORT	4.2 I	4200	2004->	8	F136S	0,7	PMR8B	6378	CPR8EA-9	2306
QUATTROPORTE	2.0 L 20V	2000	1993->	6	DH	0,8	DCPR9E	2641		
QUATTROPORTE	2.8 LX	2800	1988->	8	AM473	0,8	BPR7ES	95164		
QUATTROPORTE	3.0	3000	2016->	6	M156C	0,6	ILKAR7L11	94124	SILKAR8C-6DG	94919
QUATTROPORTE	4.2I	4200	2003->	8	F136S	0,8	PMR8B	6378	CPR8EA-9	2306
SPYDER	2.0 L	2000	1985->1987	4	452	0,8	BPR7ES	95164		
SPYDER	2.8 R V6	2800	1990->	6	SOHC	0,7	DCPR7E	3932		
SPYDER	4.2 V8	4200	2003->	8	F136R	0,7	PMR8B	6378	CPR8EA-9	2306

MAYBACH										
285.95	5.5 I V12 TURBO	5500	2006->	12		0,8	IFR6Q-G	5648		
285.98	5.7 I V12 TURBO	5700	2006->	12		0,8	IFR6Q-G	5648		
57,62	5.5 I	5500	2003->	12	M285.950	0,8	IFR6Q-G	5648		
S	6.0 I	6000	2005->	12	M285.980	0,8	IFR6Q-G	5648		

MAZDA										
130	1.6 STING, HATCH	1300	1991->	4	B3	0,8	BPR5ES	94084		
160	1.6 L	1600		4	F6	0,8	BPR5ES	94084		
160	1.6 STING, HATCH	1600	1991->	4	F6	0,8	BPR6ES	96989		
323	1.3 L,S	1300	1981->1991	4	E3 + B3	0,8	BPR5ES	94084		
323	1.3 S MIDGE, STING, HATCH	1300	1991->	4	B3	0,8	BPR5ES	94084		
323	1.4 GLC	1400	1979->1981	4	B3	0,8	BPR6ES	96989		
323	1.5 GLC, SL HATCH	1500	1981->1988	4	E5	0,8	BPR5ES	94084		
323	1.5 SL	1500	1985->1988	4	B5	0,8	BPR6ES	96989		
323	1.6 EGI	1600	1985->1988	4	B6	0,8	BPR6ES	96989		
323	1.6 I MIDGE, STING	1600	1991->	4	B6/F6	0,8	BPR6ES	96989		
323	2.0 E 8V	2000	1991->1995	4	FE	0,8	BPR5ES	94084		
323	2.0 EGI,SLI	2000	1989->1991	4	FE	0,8	BPR6ES	96989		
323	2.0 I 16V EGI DOHC	2000	1991->1994	4	FE T/C	0,8	BCPR6ES	96990	BCP6ES	94000
323	2.0 SLE	2000	1989->1991	4	FE	0,8	BPR5ES	94084		
626	1.6 L,S	1600	1983->1989	4	F6	0,8	BPR6ES	96989		
626	1.8 L	1800	1989->1992	4	F8	0,8	BPR5ES	94084		
626	2.0 16V SLI DOHC	2000	1989->1992	4	FE	0,8	BCPR6E	96245		
626	2.0 EGI	2000		4	FE	0,8	BPR6ES	96989		
626	2.0 I	2000	2000->	4	FS	1,1	PZFR6F-11	3271	ZFR6F-11	93208
626	2.0 I	2000	2000->	4	FS	1,1	PZFR6F-11	3271	ZFR6F-11	93208
626	2.0 I 16V	2000	1993->1996	4	FS	1,1	BKR6E-11	94306		
626	2.0 I V6	2000	1993->1996	6	KF	0,8	BKR6E	97737		
626	2.0 SL	2000	1989->1992	4	FE	0,8	BPR5ES	94084		
626	2.0 SLE 12V	2000	1990->1991	4	FE	0,8	BKR6E	97737		
626	2.0 SLI 8V SOHC	2000	1987->1989	4	FE	0,8	BPR6ES	96989		
626	2.5 I V6	2500	1993->1996	6	KL	1,1	BKR6E-11	94306		
ASTINA	1.8 SE 16V	1800	1995->1999	4	BPD	0,8	BKR5E	92870		
B1600	1.6 E	1600	1971->1991	4	F6	0,8	BPR5ES	94084		
B1800	1.8 L	1800	1991->1996	4	VC, F8	0,8	BPR5ES	94084		
B2000	2.0 D	2000	1997->2002	4	WLT		Y-701J	5116		
B2000	2.0 L	2000	1986->1991	4	FE	0,8	BPR5ES	94084		
B2000	2.0 S	2000	1982->1986	4	MA	0,8	BPR5ES	94084		
B2200	2.2 D	2200	1984->1990	4	S2		Y-107T	1253		
B2200	2.2 D	2200	1986->1998	4	R2		Y-107-R	1229		
B2200	2.2 I 12V	2200	1991->2000	4	F2	0,8	BKR6E	97737		
B2300	2.3 I	2300	2009->	4	L4	1,3	ITR6F-13	4477	BPR6EFS-15	4871
B2500	2.5 D	2500	1997->2001	4	WL		Y-701J	5116		
B2500	2.5 D	2500	2002->2006	4	WLE7		Y-107J			
B2500	2.5 TD	2500	1999->2006	4	WL84		Y-701J	5116		
B2600	2.6 4 X 4	2600	1988->1995	4	4G54	0,8	BPR5ES	94084		
B2600	2.6 CARB	2600	1990->1992	4	AM	0,8	BKR6E	97737		
B2600	2.6 LE	2600	1990->	4	G6	1,1	ZFR5F-11	93814		
B3000	3.0 MAGNUM	3000	1994->1996	6	ESSEX	0,8	BPR7ES	95164		
B3400	3.4 I	3400	1997->	6	ESSEX	1,1	BPR7ES-11	7226		
B4000	4.0 I V6	4000	2009->	8		1,5	TR55IX	7164	TR6IX	3689
BT-50	2.2 D	2200	2012->	4			Y1045AS	97520		
BT-50	2.5 D	2500	2006->	4	WLAA		Y-526J1	92657		
BT-50	2.5 I	2500	2010->	4		1,3	ILTR5K-13	90607		



CAR • SUV • LCV



Model	Type	Capacity	Year	Cyl	Engine	Gap	Recommended	Stock Code	Alternative	Stock Code
MAZDA										
BT-50	2.6 I	2600	2007->	4	G6	1,1	ZFR5F-11	93814		
BT-50	3.0 CDVI	3000	2006->	4	WEAT		Y-526J1	92657		
BT-50	3.2 D	3200	2010->	5			Y1045AS	97520		
CX-3	2.0 SKYACTIVE	2000	2015->	4	PEY6	1,1	ILKAR7L11	94124		
CX-5	2.0 CX-5	1998	2016->	4	PEX3/PEXB/PEXP	1,1	ILKAR7L-11			
CX-5	2.0 I SKYACTIVE	2000	2011->	4	PEY6	1,1	ILKAR7L11	94124		
CX-5	2.5 CX-5	2488	2016->	4	PYZ8/PVZC	1,1	ILKAR7L-11			
CX-5	2.5 I	2500	2014->	4	PY	1,1	ILKAR7L11	94124		
CX-7	2.3 I TURBO	2300	2007->	4	MZR DISI	0,8	ILTR6A-8G	3787	TR6B-10	94480
CX-7	2.5 I	2500	2012->	4	L5Y7	1,1	ILTR5B-11	3474	TR5B-13	97667
DRIFTER	1.8 E	1800	2000->	4	F8	0,8	BPR5ES	94084		
DRIFTER	2.2 S	2200	2000->	4	F2	0,8	BKR6E	97737		
DRIFTER	2.5 D	2500	2005->	4			Y-701J	5116		
DRIFTER	2.6 12V	2600	2000->	4	G63	0,8	BKR5E	92870		
E2000	2.0	1985	1962->1980	4	EVA	0,8	BPR6ES	96989		
E2200	2.2 D	2200	1983->	4	F2		Y-107-R	1229		
E2200	2.2 D	2200	1993->	4	R2		Y-107-R	1229		
E3000	3.0 H	3000	1993->	4	L4DE		Y-721RS	3687		
E3000	3.0 L	3000	1993->	4	VS		Y-721RS	3687		
ETUDE	180 SE 16V	1800	1995->	4	BPD	0,8	BKR5E	92870		
ETUDE	1.6 E 16V	1600	1995->	4	B6D	0,8	BKR5E	92870		
ETUDE	1.6 IE	1600	2000->	4	ZM	1,1	ZFR6F-11	93208		
ETUDE	1.8 ISE	1800	2000->	4	FP	1,1	BKR5E-11	93674		
F1000	1.0 LCV	1000	1989->	4		0,8	BPR6ES	96989		
F1300	1.3 LCV	1300	1989->	4		0,8	BPR6ES	96989		
MARATHON	2.2 BUS	2200	1996->	4	F2	0,8	BPR5ES	94084		
MARATHON	2.2 B	2200	1991->	4	F2	0,8	BPR5ES	94084		
MAZDA 2	1.3 I	1300	2007->	4	ZJ-VE	1,1	IFR5E-11	7994	BKR5E-11	93674
MAZDA 2	1.4 I	1400	2007->	4	ZJ-VEM	1,1	IFR5E-11	7994	BKR5E-11	93674
MAZDA 2	1.5 DE	1500	2015->	4	S5		CZ165	92296		
MAZDA 2	1.5 I	1500	2007->	4	ZY-VE	1,1	IFR5E-11	7994	BKR5E-11	93674
MAZDA 3	1.6 I	1600	2004->2009	4	Z601/ G27	1,1	IFR5E-11	7994	BKR5E-11	93674
MAZDA 3	1.6 I	1600	2009->	4	Z668	1,1	IFR5E-11	7994	BKR5E-11	93674
MAZDA 3	2.0 I	2000	2004->2009	4	LF-DE	1,3	ITR6F-13	4477	BPR6EFS-15	4871
MAZDA 3	2.0 I	2000	2010->2012	4	LA	1,3	ILTR5A-13G	3811	TR5B-13	97667
MAZDA 3	2.0 I	2000	2013->	4	PEY7	1,1	ILKAR7L11	94124		
MAZDA 3	2.0 MZR	2000	2009->2013	4	LF-5H/LF-5W/LF-17	1,3	LTR5B1-13			
MAZDA 3	2.3 I	2300	2005->	4	SP23 L4	1,3	ITR6F-13	4477	BPR6EFS-15	4871
MAZDA 3	2.3 I	2300	2006->	4	L4,FI	1,3	ILTR5A-13G	3811	TR5B-13	97667
MAZDA 3	2.3 MPS	2300	2007->	4	DISI	0,8	ILTR6A-8G	3787	TR6B-10	94480
MAZDA 3	2.5 S	2500	2010->	4	LA	1,3	ILTR5A-13G	3811	TR5B-13	97667
MAZDA 5	2.0 DI	2000	2005->2010	4	RF7J		Y-529J	4664		
MAZDA 5	2.0 I	2000	2005->	4	LF-VE	1,3	ILTR5A-13G	3811	TR5B-13	97667
MAZDA 5	2.0 I	2000	2005->	4	MZR-LF	1,3	ITR6F-13	4477	BPR6EFS-15	4871
MAZDA 5	2.0 I	2000	2010->	4	LFZB	1,3	ILTR6A-13G	3789	TR6B-10	94480
MAZDA 6	2.0	1998	2014->	4	PE-VP		ILKAR7L-11			
MAZDA 6	2.0 I	2000	2003->2005	4	LF-DE	1,3	ITR6F-13	4477	BPR6EFS-15	4871
MAZDA 6	2.0 I	2000	2007->	4	LF-VE	1,3	ILTR5A-13G	3811	TR5B-13	97667
MAZDA 6	2.3 I	2300	2003->2005	4	L3-VE	1,3	ITR6F-13	4477	BPR6EFS-15	4871
MAZDA 6	2.3 I	2300	2008->	4	L3-VE	1,3	ILTR5A-13G	3811	TR5B-13	97667
MAZDA 6	2.3 MPS	2300	2007->	4	DISI	0,8	ILTR6A-8G	3787	TR6B-10	94480
MAZDA 6	2.5 I	2500	2008->	4	S-VT	1,3	ILTR5A-13G	3811	TR5B-13	97667
MAZDA 6	2.5 I	2500	2009->	4	L5-VE	1,3	ITR6F-13	4477	BPR6EFS-15	4871
MAZDA 6	2.5 I	2500	2014->	4	PYY1	1,1	ILKAR7L11	94124		
MPV	2.0 D	2000	1997->2002	4	WLT		Y-701J	5116		
MX-5	1.6 I	1600	1990->1993	4	B6	1,1	BKR6E-11	94306		
MX-5	1.8 I	1800	2001->2005	4	BPZE	1,1	BKR5E-11	93674		
MX-5	1.8 I	1800	2006->	4		1,3	ITR6F-13	4477	BPR6EFS-15	4871
MX-5	2.0 I	2000	2006->	4	LF-VE	1,3	ILTR6A-13G	3789	TR6B-10	94480
MX-5	2.0 MIATA	2000	2006->2009	4	FI	1,3	ILTR6A-13G	3789	TR6B-10	94480
MX-6	2.5 I V6	2500	1993->1998	6	KL	1,1	BKR6E-11	94306		
RANGER	2.2 D	2200		4	S2		Y-107T	1253		
RUSTLER	1.3 L	1300	1994->2002	4	KENT, B3	0,8	BPR6ES	96989		
RUSTLER	1.4 S	1400	1986->1993	4	CVH	0,8	BPR6ES	94000	BCPR6ES	96990
RUSTLER	1.6 I	1600	1994->	4	B6	0,8	BPR6ES	96989		
RUSTLER	1.6 L	1600	1986->1991	4	CVH	0,8	BPR6ES	94000	BCPR6ES	96990
RX-7	FB				12A	0,8	BR8EG	3130		
RX-7	FC / FD		1986->1995		12AN2	1	BUR7EQ	3559		
RX-7	ROTARY		1990->		RE13B	1,8	BUR7EQ	3559		
RX-7	ROTARY		1990->		RE13B	1,8	BUR9EQ	5483		
RX-7	ROTARY		1995->		13B	0,8	BR10EG	3830		
RX-7	TURBO		1990->		RE13B	1	BUR9EQ	5483		

MAZDA



CAR • SUV • LCV



Model	Type	Capacity	Year	Cyl	Engine	Gap	Recommended	Stock Code	Alternative	Stock Code
MAZDA										
RX-7	TWIN TURBO		1990->		13B-REV	1	BUR9EQ	5483		MAZDA
RX-8	2.6 I		2003->		13B-MSP	0,8	RE8C-L + RE9B-T	5745+2809		
RX-8 SPORT	2.6 I		2003->			0,8	RE8C-L + RE9B-T	5745+2809		
SOHO	1.3 I21	1300	1997->1998	4	HCS ENDURA		BPR6EFS	92170		
SOHO	1.4 I21	1400	1998->	4	CVH		BCPR6ES	96990	BCP6ES	94000
T2000	2.0 LCV	2000	1981->1985	4	VA		BPR6ES	96989		

MEIYA										
PICK-UP	2.2 I	2200	2007->	4	4Y		BPR5EY	94270		
PICK-UP	2.2 I	2200	2008->	4			BPR6ES	96989		
PICK-UP	2.8 TD	2800	2007->	4	4JB1		Y-904M1	7995		

MERCEDES BENZ										
190	W201	1800	1990->1993	4	M102.910		BP6EFS	93834	BPR6EFS	92170
190	W201	2000	1985->1994	4	M102.962		BP6EFS	93834	BPR6EFS	92170
190	W201	2300	1993->1994	4	M102.985		BP6EFS	93834	BPR6EFS	92170
190	W201	2500	1989->1993	5	M 602.961		Y-916J	4454		
200	W123	2000	1981->1986	4	M102.920		BP6EFS	93834	BPR6EFS	92170
200	W124	2000	1986->1990	4	M102.922		BP6EFS	93834	BPR6EFS	92170
200 D,TD	W124	2000	1984->1989	4	M 601.912		Y-924J	3473		
200E	W124	2000	1990->1993	4	M102.963		BP6EFS	93834	BPR6EFS	92170
200E,CE,TE	W124	2000	1990->1993	4	M111.940		BCP6ET	4563		
200T	W123	2000	1990->	4	M102.920		BP6EFS	93834	BPR6EFS	92170
207 D	2.4 D	2400	1982->1988	4	M 616.		Y-924J	3473		
209 D	3.0 D	3000	1982->1988	4	M 617.		Y-924J	3473		
220E,CE,TE	W124	2200	1992->1993	4	M111.960		BCP6ET	4563		
230	W123	2300	1977->	4	M102.115		BPR5ES	94084		
230E,TE,CE	W123	2300	1981->1986	4	M102.980		BP6EFS	93834	BPR6EFS	92170
230E,TE,CE	W124	2300	1986->1993	4	M102.982		BP6EFS	93834	BPR6EFS	92170
240 D,TD	W123	2400	1980->1984	4	M 616.912		Y-924J	3473		
250	W123	2500	1977->1980	6	M123.920		BP6ES	91076		
250 DT	W124	2500	1988->1989	5	OM 602.962		Y-924J	3473		
250 D,TD	W124	2500	1985->1989	5	OM 602.912		Y-924J	3473		
250 GD	W460	2500	1987->1989	5	OM 602.930		Y-924J	3473		
260E	W124	2600	1986->1992	6	M103.940		BP6EFS	93834	BPR6EFS	92170
280E, CE	W123	2800	1977->1986	6	M110.984		BPR6ES	96989		
280E,TE	W124	2800	1993->1995	6	M104.942		BCP6ET	4563		
280S	W116	2800	1973->1981	6	M110.922		BPR6ES	96989		
280SE	W116	2800	1973->1981	6	M110.983		BPR6ES	96989		
280SE	W126	2800	1987->	6	M110.989		BPR6ES	96989		
280SL	W107	2800	1990->	6	M110.990		BPR6ES	96989		
280TE	W123	2800	1990->	6	M110.984		BPR6ES	96989		
300 D	W123	3000	1980->1981	6	OM 617.912		Y-924J	3473		
300 D	W124	3000	1986->1989	6	OM 603.913		Y-924J	3473		
300 D	W126 TD	3000	1985->1987	6	OM 603.961		Y-924J	3473		
300E	W124	3000	1987->1993	6	M103.983		BP6EFS	93834	BPR6EFS	92170
300SE	W126	3000	1986->1992	6	M103.981		BP6EFS	93834	BPR6EFS	92170
320E	W124	3200	1993->	6	M104.992		BCP6ET	4563		
350SE	W116	3500	1972->1976	8	M116.983		BPR6ES	96989		
350SE	W116	3500	1976->1980	8	M116.983		BPR6ES	96989		
380SE	W126	3800	1979->1985	8	M116.963		BPR6ES	96989		
420SE	W126	4200	1986->1989	8	M116.965		BPR6ES	96989		
450SL	W116	4500	1977->1980	8	M117.982		BPR6ES	96989		
450SLC	W116	4500	1977->1980	8	M117.982		BPR6ES	96989		
500SE	W126	5000	1989->1992	8	M117.941,963,965		BPR6ES	96989		
500SL	W129	5000	1992->1993	8	M119.972		BCP6ET	4563		
600SEL	W140	6000	1991->1993	12	M120.980		BCP6ET	4563		
A160	W168 CLASSIC	1600	2000->	4	M166.960		BKUR6ET-10	90599		
A170	W168 CDI	1700	2002->	4	OM 668.942		Y-746J	7992		
A170	W169	1700	2005->	4	M 266.940		BKR6EZB	4293		
A180	1.6 T	1800	2012->	4	M270.910		SILZKFR8E7S	90654		
A180	W169 CDI	1800	2004->	4	M640.940		Y8002AS	6286		
A180	W176 CDI	1800	2012->	4	OM651.901		CZ303	9970		
A190	W168 ELEGANCE	1900	1999->	4	M166.990		BKUR6ET-10	90599		
A200	W169	2000	2004->2011	4	M266.960		BKR6EZB	4293		
A200	W176 1.6 T	1600	2012->	4	M270.970		SILZKFR8D7S	95875		
A200	W176 CDI	2000	2011->	4	OM651.901		CZ303	9970		
A210	W168	2000	2002->	4	M166.995		BKUR5ETC-10	90531		
A220	W176 CDI	2200	2012->	47	OM651.930		CZ303	9970		
A250	W176 2.0 T	2000	2013->	4	M270.920		SILZKFR8E7S	90654		



CAR • SUV • LCV

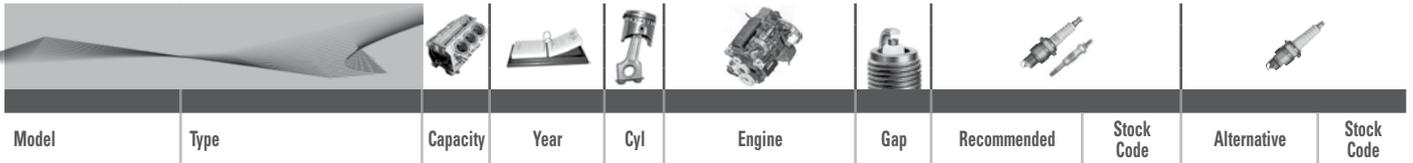

Model	Type	Capacity	Year	Cyl	Engine	Gap	Recommended	Stock Code	Alternative	Stock Code
MERCEDES BENZ										
A45 AMG	2.0 T	2000	2013->	4	M133.980	0,7	SILZKFR8D7S	95875	MERCEDES BENZ	
B 150	W245	1500	2005->	4	M266.920	0,8	BKR6EZB	4293		
B 170	W245	1700	2005->	4	M266.940	0,8	BKR6EZB	4293		
B 180	W245	1800	2008->	4	M266.960	0,8	BKR6EZB	4293		
B 180	W245 CDI	1800	2005->2007	4	OM640.940		Y8002AS	6286		
B 180	W245 CDI	1800	2005->2007	4	OM640.940		Y8002AS	6286		
B 180	W246 CDI	1800	2011->	4	OM651.901		CZ303	9970		
B 200	W 246 1.6	1600	2011->	4	M270.910	0,7	SILZKFR8D7S	95875		
B 200	W245	2000	2005->	4	M266.960	0,8	BKR6EZB	4293		
B 200	W245	2000	2011->	4	M266.980	1	IFR6D-10	5344	BKR6E-11	94306
B 200	W245 CDI	2000	2005->2007	4	OM640.941		Y8002AS	6286		
B 200	W245 CDI	2000	2007->2011	4	OM640.941		Y8002AS	6286		
B 200	W246 CDI	1800	2011->	4	OM651.901		CZ303	9970		
B 220	W246	2200	2011->	4	OM651.930		CZ303	9970		
B 250	W246 2.0 T	2000	2012->	4	M270.920	0,7	SILZKFR8E7S	90654		
C180	W202	1800	1994->2000	4	M111.920	0,8	BCP6E	5860	BCPR6E	96245
C180	W202 D	1800	1998->2000	4	OM 604.		Y-925J	5740		
C180	W203	2000	2001->	4	M111.951	1	IFR6D-10	5344	BKR6E-11	94306
C180	W203 KOMPRESSOR	1800	2003->2006	4	M271.940	0,8	ILFR6A	3588	IFR6A-11	3672
C180	W203 KOMPRESSOR	1800	2006->	4	M271.940	0,8	PLKR7B-8E	94716		
C180	W204	1600	2012->	4	M274.910	0,7	SILZKFR8D7S	95875	SILZKFR8E7S	90654
C180	W204 CGI	1800	2007->	4	M271.820	0,8	PLKR7B-8E	94716		
C180	W204 KOMPRESSOR	1600	2008->	4	M271.910	0,8	PLKR7A	4288		
C190	AMG 4.0 GTS	4000	2015->	8	M178.980	0,7	SILZKFR8E7S	90654		
C200	W202	2000	1996->2000	4	M111.941	0,8	BCPR6E	96245		
C200	W203 KOMPRESSOR	1800	2006->	4	M271.942	0,8	PLKR7B-8E	94716		
C200	W203 KOMPRESSOR	2000	2000->	4	M111.920,955	1	IFR6D-10	5344	BKR6E-11	94306
C200	W203 KOMPRESSOR	1800	2003->2006	4	M271.942	0,8	ILFR6A	3588	IFR6A-11	3672
C200	W204 CGI KOMPRESSOR	1800	2007->	4	M271.950	0,8	PLKR7B-8E	94716		
C200	W204 CDI	2200	2007->	4	OM646.812		CZ106	9883		
C220	W202	2200	1994->1997	4	M111.961	0,8	BCP6E	5860	BCPR6E	96245
C220	W203 CDI	2200	2002->	4	M611.960,961,962		Y-745U	4705		
C220	W204 CDI	2200	2007->	4	OM646.811		CZ106	9883		
C220	W204 CDI	2200	2008->	4	OM651.911		CZ303	9970		
C230	W 203	2500	2004->	6	M272.920	0,8	PLKR7A	4288	LKR7B-9	5847
C230	W202 C230	2300	1996->1998	4	M111.974	0,8	BCP6E	5860	BCPR6E	96245
C230	W202 C230K SPORTS-COUPE	2300	1996->2000	4	M111.975	1	BKUR6ET-10	90599		
C230	W203 C230	1800	2004->	4	M271.948	0,8	ILFR6A	3588	IFR6A-11	3672
C230	W203 C230K KOMPRESSOR	2300	2001->2002	4	M111.981	1	IFR6D-10	5344	BKR6E-11	94306
C230	W204 C230K	2500	2007->	6	M272.911,M272.921	0,8	PLKR7A	4288		
C240	W202 V6 ELEGANCE	2400	1998->2000	6	M112.910	1,1	IFR5D-10	4696	BKR5E-11	93674
C240	W203 V6 ELEGANCE	2600	2001->2005	6	M112.912	1,1	IFR5D-10	4696	BKR5E-11	93674
C250	W202 D	2500	1995->1998	5	OM 605.910		Y-925J	5740		
C250	W202 TD	2500	1996->2000	5	OM 605.960		Y-925J	5740		
C250	W204	2200	2008->2010	4	M651.911		CZ303	9970		
C250	W204 CDI	2500	2011->	4	OM651.912		CZ303	9970		
C250	W204 CGI	1800	2009->	4	M271.860	0,8	PLKR7B-8E	94716		
C270	W203 CDI	2700	2000->	5	OM 612.962		Y-745U	4705		
C280	W202	2800	1994->1997	6	M104.901	0,8	BCP6E	5860	BCPR6E	96245
C280	W202	2800	1994->2000	6	M112.920	1,1	PFR5J-11	4642	BKR5E-11	93674
C280	W203	3000	2007->	6	M272.941	0,8	PLKR7A	4288		
C280	W204	3000	2007->	6	M272.947,M272.948	0,8	PLKR7A	4288		
C300	W 204	3000	2009->	6	M272.947	0,8	PLKR7A	4288	LKR7B-9	5847
C32	W203 AMG	3200	2000->	6	M112.691	1	IFR6D-10	5344	BKR6E-11	94306
C320	W203	3200	2001->2005	6	OM112.946	1,1	IFR5D-10	4696	BKR5E-11	93674
C320	W203 CDI	3000	2004->2007	6	OM642.910		Y8002AS	6286		
C320	W204 CDI	3000	2007->	6	OM642.961		Y8002AS	6286		
C350	W203	3500	2005->	6	M272.960,970	0,8	PLKR7A	4288		
C350	W204	3500	2007->	6	M272.961	0,8	PLKR7A	4288		
C350	W204 CDI	3000	2009->	6	OM642.960/961		Y8002AS	6286		
C350	W204 CDI	3000	2009->2010	6	OM642.830		CZ303	9970		
C350	W204 CDI	3000	2009->2010	6	OM642.832		CZ303	9970		
C350	W204 CGI	3500	2008->	6	M272.982	0,8	SILZKR7A-S	7718		
C55	W203 AMG TWIN SPARK	5400	2004->	8	M113.988	1	IFR6D-10	5344	BKR6E-11	94306
C63	C63S AMG	3982	2015->	8	M177.980		SILZKFR8E7S	90654		
C63	W204 AMG	6300	2007->	8	M156.985	1	ILZKAR7A-10	6043		
C63AMG	W205 4.0 T	4000	2015->	8	M177.980	0,7	SILZKFR8E7S	90654		
CL500	W215	5000	2000->	8	M113.960	1,1	PFR5R-11	4292	BKR5E-11	93674
CL500	W216	5500	2006->	8	M273.961	0,8	PLKR7A	4288		
CL55	W215 AMG	5500	2001->	8	M113.986	1,1	PFR5R-11	4292	BKR5E-11	93674
CL55	W215 AMG KOMPRESSOR	5500	2001->	8	M113.991	0,8	ILFR6A	3588	IFR6A-11	3672
CL600	W140	6000	2000->	12	M120.982	1,1	PFR5R-11	4292	BKR5E-11	93674

MERCEDES BENZ



CAR • SUV • LCV



Model	Type	Capacity	Year	Cyl	Engine	Gap	Recommended	Stock Code	Alternative	Stock Code
MERCEDES BENZ						MERCEDES BENZ				
CL600	W216 TWIN SPARK	6000	2006->	12	M275.953	0,8	IFR6Q-G	5648		
CL63	W216 AMG	6300	2006->	8	M156.984	1	ILZKAR7A-10	6043	LZKAR7A	6799
CL65	W215 AMG	6000	2003->	12	M275.980	0,8	IFR6Q-G	5648		
CL65	W216 AMG	6000	2007->	12	M275.982	0,8	IFR6Q-G	5648		
CLA200	W117 CGI	1600	2012->	4	M270.910	0,7	SILZKFR8D7S	95875		
CLA220	W117 CDI	2200	2013->	4	OM651.930		CZ303	9970		
CLA250	W117 CGI	2000	2012->	4	M270.920	0,7	SILZKFR8E7S	90654		
CLA45AMG	W 117 AMG	2000	2013->	4	M133.980	0,7	SILZKFR8E7S	90654		
CLC 180	W203 KOMPRESSOR	1800	2008->	4	M271.946	0,8	ILFR6A	3588	LF6A-11	3672
CLC 230	W203	2500	2008->	6	M272.920	0,8	PLKR7A	4288		
CLC 350	W203	3500	2008->	6	M272.960	0,8	PLKR7A	4288		
CLC200	W203 KOMPRESSOR	1800	2008->	4	M271.957	0,8	PLKR7B-8E	94716		
CLK220	W209	2200	2005->	4	OM646.966		Y-745U	4705		
CLK230	W208 KOMPRESSOR	2300	1998->2000	4	M111.973	1	BKUR6ET-10	90599		
CLK230	W208 KOMPRESSOR	2300	2000->2002	4	M111.982	1	IFR6D-10	5344	BKR6E-11	94306
CLK320	W208 COUPE	3200	1998->2002	6	M112.940	1,1	PFR5R-11	4292	BKR5E-11	93674
CLK320	W209	3200	2003->	6	M112.955	1,1	PFR5R-11	4292	BKR5E-11	93674
CLK320	W209 CDI	3000	2005->	6	OM642.910		Y8002AS	6286		
CLK350	W209	3500	2006->	6	M272.960	0,8	PLKR7A	4288		
CLK430	W208 ELEGANCE	4300	2000->	8	M113.943	1,1	IFR5D-10	4696	BKR5E-11	93674
CLK500	W209	5000	2002->	8	M113.968	1,1	PFR5J-11	4642	BKR5E-11	93674
CLK500	W209	5000	2002->	8	M113.968	1,1	PFR5R-11	4292	BKR5E-11	93674
CLK500	W209	5500	2006->	8	M273.967	0,8	PLKR7A	4288		
CLK55	W208 AMG	5500	1993->2002	8	M113.980	1,1	PFR5R-11	4292	BKR5E-11	93674
CLK55	W209 AMG	5400	2002->	8	M113.987	1	IFR6D-10	5344	BKR6E-11	94306
CLK63	W209	6300	2006->2006	8	M156.982	1	ILZKAR7A-10	6043		
CLK63	W209	6300	2007->	8	M156.982	1	ILZKAR7A-10	6043		
CLS250	W218 CDI	2100	2010->	4	OM651.924		CZ303	9970		
CLS320	W219	3000	2005->	6	OM642.920		Y8002AS	6286		
CLS350	W219	3500	2004->	6	M272.964	0,8	PLKR7A	4288	LKR7B-9	5847
CLS350	W219 CGI	3500	2006->	6	M272.985	0,8	SILZKR7A-S	7718		
CLS400	X218 3.5 I	3500	2013->	6	M276.850	0,7	SILZKFR8E7S	90654		
CLS500	W219	5000	2006->	8	M113.967	1,1	PFR5J-11	4642	BKR5E-11	93674
CLS500	W219	5000	2006->	8	M273.960	0,8	PLKR7A	4288		
CLS500AMG	W219 4.7 I	4700	2012->	8	M278.922	0,8	SILZKR7A-S	7718		
CLS55	W219	5500	2006->	8	M113.990	0,8	ILFR6A	3588	LF6A-11	3672
CLS63	W219 AMG	6300	2006->	8	M156.983	1	ILZKAR7A-10	6043		
CLS63 SHOOTING BREAK	X218 5.5 I	5500	2012->	8	M157.981	0,8	SILZKR7A-S	7718		
CLS63AMG	X218 5.5 I	5500	2012->	8	M157.981	0,8	SILZKR7A-S	7718		
E200	W124	2000	1993->1995	4	M111.940	0,8	BCP6E	5860	BCPR6E	96245
E200	W210 KOMPRESSOR	2000	2001->2003	4	M111.957	1	IFR6D-10	5344	BKR6E-11	94306
E200	W211 KOMPRESSOR	1800	2006->	4	M271.956	0,8	PLKR7B-8E	94716		
E200	W211 KOMPRESSOR	1800	2006->2006	4	M271.956	0,8	ILFR6A	3588	LF6A-11	3672
E200	W211 KOMPRESSOR	1800	2002->2006	4	M271.941	0,8	PLKR7B-8E	94716		
E200	W212 CDI	2200	2009->	4	OM651.925		CZ303	9970		
E200	W212 CDI BLUE EFFICIENCY	2200	2009->	4	OM651.925		CZ303	9970		
E200	W212 CGI	1800	2009->	4	M271.820	0,8	PLKR7B-8E	94716		
E220	W124	2200	1993->1996	4	M111.960	0,8	BCP6E	5860	BCPR6E	96245
E220	W211 CDI	2200	2003->	4	OM646.961		Y-745U	4705		
E220	W212 CDI	2200	2009->	4	OM651.924		CZ303	9970		
E220	W212 CDI BLUE EFFICIENCY	2200	2009->	4	OM651.924		CZ303	9970		
E230	W210	2300	1996->1998	4	M111.970	0,8	BCP6E	5860	BCPR6E	96245
E240	W210	2600	2000->2003	6	M112.914	1,1	IFR5D-10	4696	BKR5E-11	93674
E240	W210 ELEGANCE	2400	1997->1999	6	M112.911	1,1	IFR5D-10	4696	BKR5E-11	93674
E240	W211	2600	2003->	6	M112.917	1,1	IFR5D-10	4696	BKR5E-11	93674
E240	W211 V6	2600	2001->	6	M112.913	1,1	IFR5D-10	4696	BKR5E-11	93674
E250	W212 BLUE EFFICIENCY	2200	2009->	4	OM651.924		CZ303	9970		
E250	W212 CGI	1800	2009->	4	M271.860	0,8	PLKR7B-8E	94716		
E270	W210 CDI	2700	1999->	5	M612.961		Y-745U	4705		
E270	W211CDI	2700	2001->	5	M647.961		Y-745U	4705		
E280	W124,W210	2800	1995->1997	6	M104.945	0,8	BCP6E	5860	BCPR6E	96245
E280	W210	2800	1997->	6	M112.921	1,1	IFR5D-10	4696	BKR5E-11	93674
E280	W211	3000	2005->	6	M642.921		Y8002AS	6286		
E280	W211	3000	2006->	6	M272.944	0,8	PLKR7A	4288		
E280	W211	3200	2004->	6	M648.961		Y-745U	4705		
E300	3.0 M276	2996	2011->2016	6	M276.952	0,8	PLKR7A	4288	LKR7B-9	5847
E300	CDI BLUEEFFICIENCY	2200	2014->	4	OM642.850		CZ303	9970		
E300	W124	3000	1993->1997	6	M104.980	0,8	BCP6ES	94000	BCPR6ES	96990
E300	W211 CDI	3000	2008->	6	OM642.920		CZ303	9970		
E300	W212 3.0 V6	3000	2009->2010	6	M272.952	0,8	PLKR7A	4288	LKR7B-9	5847
E320	W124,W210	3200	1993->1997	6	M104.992	0,8	BCP6E	5860	BCPR6E	96245
E320	W210	3200	1996->1997	6	M112.941	1,1	IFR5D-10	4696	BKR5E-11	93674



CAR • SUV • LCV



Model	Type	Capacity	Year	Cyl	Engine	Gap	Recommended	Stock Code	Alternative	Stock Code
MERCEDES BENZ										
E320	W210 CDI	3200	1999->	6	M 613.961		Y-745U	4705		
E320	W211	3000	2005->	6	M642.920		Y8002AS	6286		
E320	W211	3200	2002->	6	M112.949	1	IFR6D-10	5344	BKR6E-11	94306
E320	W211 CDI	3200	2005->	6	M648.961		Y-745U	4705		
E350	W211	3500	2004->	6	M272.964	0,8	PLKR7A	4288		
E350	W211 4 MATIC	3500	2004->	6	M272.972	0,8	PLKR7A	4288		
E350	W211 CGI	3500	2008->	6	M272.985	0,8	SILZKR7A-S	7718		
E350	W212 BLUE EFFICIENCY	3500	2009->	6	M272.983	0,8	SILZKR7A-S	7718		
E350	W212 CDI BLUE EFFICIENCY	3000	2009->2010	6	OM642.850		CZ303	9970		
E350	W212 CDI BLUE TECH	3000	2009->2010	6	OM 642.850		CZ303	9970		
E400	S212 3.0 I	3000	2013->	6	M276.850	0,7	SILZKR8E7S	90654		
E420	W211 CDI	4000	2005->	8	OM629.910		Y8002AS	6286		
E430	W210 ELEGANCE	4300	1998->2003	8	M113.940	1,1	IFR5D-10	4696	BKR5E-11	93674
E500	W211	5000	2002->	8	M113.967	1,1	PFR5R-11	4292	BKR5E-11	93674
E500	W211	5500	2006->	8	M273.960,2	0,8	PLKR7A	4288		
E500	W212	5500	2009->	8	M273.971	0,8	PLKR7A	4288		
E55	W211 AMG	5500	2002->	8	M113.990	0,8	ILFR6A	3588	LFK6A-11	3672
E63	W211 AMG	6300	2006->	8	M156.983	1	ILZKAR7A-10	6043	LZKAR7A	6799
E63	W212 5.5 I	5500	2011->	8	M157.981	0,8	SILZKR7A-S	7718		
E63 S	W212 6.3I	6300	2012->	8	M157.981	0,8	SILZKR7A-S	7718		
G270	W461 2.7 D	2700	2001->	5	OM612.965		Y-745U	4705		
G290	W461 2.9 D	2900	1993->	6	OM 602.942/947		Y-916J	4454		
G300	W461 CDI	3000	2013->	6	OM642.882		CZ303	9970		
G300	W463 3.0 D	3000	1993->	6	OM 603.931		Y-916J	4454		
G300	W463 3.0 DT	3000	1996->	6	OM 606.964		Y-925J	5740		
G300	W463 3.0 I	3000	1993->1994	6	M 103.987	0,8	BP6EFS	93834	BPR6EFS	92170
G320	W463 3.0 DT	3000	2006->	6	OM642.970		CZ303	9970		
G350	3.5 DT W463	3500	1993->	6	OM 603.972		Y-916J	4454		
G350	W463 CDI	3000	2015->	6	OM642		CZ303	9970		
G500	W463 5.0 I	5000	2000->	8	M113.962	1,1	PFR5R-11	4292	BKR5E-11	93674
G500	W463 5.5 I	5500	2008->	8	M273.963	0,8	PLKR7A	4288	LKR7B-9	5847
G55	W463 5.5 I	5500	2004->	8	M113.993	0,8	ILFR6A	3588	LFK6A-11	3672
G63	W463 6.3 I	6300	2013->2015	8	M157.984	0,8	SILZKR7A-S	7718		
GL320	W164 3.0 CDI	3000	2006->	6	OM642.940		Y8002AS	6286		
GL350	W164 3.0 CDI	3000	2009->	6	OM642.820		CZ303	9970		
GL450	W164 4.5 I	4500	2007->	8	M273.923	0,8	PLKR7A	4288	LKR7B-9	5847
GL500	W164 5.5 I	5500	2006->	8	M273.963	0,8	PLKR7A	4288	LKR7B-9	5847
GL63	X166 5.5	5500	2013->	8	M157.982	0,8	SILZKR7A-S	7718		
GLA	45 AMG	2000	2013->	4	M133.980	0,7	SILZKR8E7S	90654		
GLA	GLA200	1600	2013->	4	M270.910	0,7	SILZKR8D7S	95875		
GLA	GLA250	2000	2013->	4	M270.920	0,7	SILZKR8E7S	90654		
GLC	250 T X156	2000	2016->	4	M270.920	0,7	SILZKR8E7S	90654		
GLE	GLE400	2996	2015->2019		M276.821	0,7	SILZKR8E7S	90654		
GLE	GLE450	2996	2018->2018		M276.821	0,7	SILZKR8E7S	90654		
GLE	W166 400 T	3000	2016->	6	M276.871	0,7	SILZKR8E7S	90654		
GLE	W166 43AMG	3000	2016->	6	M276.821	0,7	SILZKR8E7S	90654		
GLE	W166 500 T	4700	2016->	8	M278.928	0,8	SILZKR7A-S	7718		
GLE	W166 63AMG	5500	2016->	8	M157.982	0,8	SILZKR7A-S	7718		
GLE	W166 63AMG S	5500	2016->	8	M157.982	0,8	SILZKR7A-S	7718		
GLS	W166 63 AMG	5500	2016->	8	M157.982	0,8	SILZKR7A-S	7718		
GLS	X166 350D	3000	2016->	6	OM652.826		CZ303	9970		
MB100	2.4 D	2400	1987->1989	4	OM 616.963		Y-924J	3473		
MB100	2.4 D	2400	1989->	4	OM 616.963		Y-916J	4454		
ML	W163 2.7 CDI	2700	2000->	6	M612.960		Y-745U	4705		
ML	W163 3.2 CDI	3000	2005->	6	OM642.940		Y8002AS	6286		
ML	W163 3.2 I	3200	2000->	6	M112.942	1,1	PFR5J-11	4642	BKR5E-11	93674
ML	W163 3.7 I	3700	2000->2005	6	M112.970	1,1	PFR5R-11	4292	BKR5E-11	93674
ML	W163 4.3 I	4300	2000->	8	M113.942	1,1	PFR5J-11	4642	BKR5E-11	93674
ML	W163 5.5 AMG	5500	2002->2005	8	M113.981	1,1	PFR5R-11	4292	BKR5E-11	93674
ML	W164 3.0 CDI	3000	2006->	6	OM642.940		Y8002AS	6286		
ML	W164 3.5 CDI	3500	2009->	6	OM642.820		CZ303	9970		
ML	W164 3.5 I	3500	2007->	6	M272.967	0,8	PLKR7A	4288	LKR7B-9	5847
ML	W164 4.0 CDI	4000	2006->	8	OM629.912		Y8002AS	6286		
ML	W164 5.0 I	5000	2006->	8	M113.964/5	1,1	PFR5J-11	4642	BKR5E-11	93674
ML	W164 5.5 I	5500	2007->	8	M273.963	0,8	PLKR7A	4288	LKR7B-9	5847
ML	W164 6.3 AMG	6300	2006->	8	M156.980	1	ILZKAR7A-10	6043	LZKAR7A	6799
ML	W166 250 CDI	2500	2012->2015	4	OM651.960		CZ303	9970		
ML	W166 2.5 CDI	2500	2011->	4	OM651.960		CZ303	9970		
ML	W166 ML400	3000	2014->2015	6	M276.821	0,7	SILZKR8D7S	95875		
ML	W166 ML63AMG	5500	2012->2015	8	M157.982	0,8	SILZKR7A-S	7718		
R63	W251 AMG	6300	2006->	8	M156.980	1	ILZKAR7A-10	6043	LZKAR7A	6799
R300	W251	3000	2009->	6	OM642.950		Y8002AS	6286		

MERCEDES BENZ



CAR • SUV • LCV



Model	Type	Capacity	Year	Cyl	Engine	Gap	Recommended	Stock Code	Alternative	Stock Code
MERCEDES BENZ						MERCEDES BENZ				
R300	W251	3000	2009->	6	M272.945	0,8	PLKR7A	4288	LKR7B-9	5847
R350	W251	3500	2007->	6	M272.967	0,8	PLKR7A	4288		
R500	W251	5000	2007->	8	M113.971	1,1	PFR5R-11	4292	BKR5E-11	93674
R500	W251	5500	2007->	8	M273.963	0,8	PLKR7A	4288		
S250	W221 250 CDI	2500	2011->	4	OM651.961		CZ303	9970		
S300	W140	3000	1999->	6	OM 606.961		Y-925J	5740		
S320	W140	3200	1993->1994	6	M104.990	0,8	BCPR6ES	96990	BCP6ES	94000
S320	W220	3200	2000->	6	M112.944	1,1	PFR5R-11	4292	BKR5E-11	93674
S320	W220 CDI	3200	1999->	6	OM 648.960		Y-745U	4705		
S320	W221 CDI	3000	2006->	6	OM642.930		Y8002AS	6286		
S350	W220	3700	2004->	6	M112.972	1,1	PFR5R-11	4292	BKR5E-11	93674
S350	W221	3500	2005->	6	M272.965	0,8	PLKR7A	4288		
S400	W220 CDI	4000	2000->	8	OM 628.960		Y-745U	4705		
S400	W221 BLUEHYBRID	3500	2009->	6	M272.974	0,8	PLKR7A	4288	LKR7B-9	5847
S420	W140	4200	1996->1998	8	M119.971	0,8	BCPR6ES	96990	BCP6ES	94000
S430	W220	4300	2000->	8	M113.941	1,1	IFR5D-10	4696	BKR5E-11	93674
S500	W140	5000	1993->1999	8	M119.970	0,8	BCP6ES	94000	BCPR6ES	96990
S500	W220	5000	2000->	16	M113.960	1,1	PFR5R-11	4292	BKR5E-11	93674
S500	W221	5000	2006->	8	M273.961	0,8	PLKR7A	4288		
S500	W222 4.7 I	4700	2013->	8	M278.929	0,8	SILZKR7A-S	7718		
S55	W220 AMG	5500	1999->	8	M113.986	1,1	PFR5R-11	4292	BKR5E-11	93674
S55	W220 AMG KOMPRESSOR	5500	2003->	8	M113.991	0,8	ILFR6A	3588	LF6A-11	3672
S600	W140	6000	1996->2000	12	M120.980	0,8	BCPR6ES	96990	BCP6ES	94000
S600	W220	6000	2000->2002	12	M137.970	1	IFR6D-10	5344	BKR6E-11	94306
S600	W220	6000	2002->	12	M275.950	0,8	IFR6Q-G	5648		
S600	W221	6000	2006->	12	M275.953	0,8	IFR6Q-G	5648		
S600	W222	6000	2006->	12	M275.953 TS	0,8	IFR6Q-G	5648		
S63	W221	5500	2006->	8	M156.984	1	ILZKAR7A-10	6043	LZKAR7A	6799
S63	W222 S63AMG	5500	2013->	8	M197.985	0,8	SILZKR7A-S	7718		
S65	S65AMG	6000	2013->	12	M275.982	0,8	IFR6Q-G	5648		
S65	W221 AMG	6000	2006->	12	M275.982	0,8	IFR6Q-G	5648		
SL320	R129	3200	1998->	6	M112.943	1,1	PFR5R-11	4292	BKR5E-11	93674
SL400	R231 SL400	3000	2013->	6	M276.825	0,7	SILZKFR8E7S	90654		
SL500	R129	5000	1998->	8	M113.961	1,1	PFR5J-11	4642	BKR5E-11	93674
SL500	R230	5000	2002->	8	M113.963	1,1	PFR5R-11	4292	BKR5E-11	93674
SL500	R230	5500	2006->	8	M273.965	0,8	PLKR7A	4288		
SL500	R231 SL500	4700	2013->	8	M278.927	0,8	SILZKR7A-S	7718		
SL55	R230 AMG	5500	2002->	8	M113.992	0,8	ILFR6A	3588	LF6A-11	3672
SL600	R129	6000	1998->	12	M120.983	1,1	IFR5D-10	4696	BKR5E-11	93674
SL600	R129	6000	2001->	12	M120.983	1,1	PFR5R-11	4292	BKR5E-11	93674
SL600	R230	5500	2001->	12	M275.951	0,8	BKR6EIX	6418		
SL63	R230	5500	2008->	8	M156.981	1	ILZKAR7A-10	6043	LZKAR7A	6799
SL63	R231 SL63AMG	5500	2013->	8	M197.983	0,7	SILZKR7A-S	7718		
SL65	R230 AMG	6000	2006->	12	M275.981	0,8	IFR6Q-G	5648		
SL73	W129 AMG	7300	1999->	12	M120.E73	1,1	IFR5D-10	4696	BKR5E-11	93674
SLK200	R170	2000	1997->2000	4	M111.943	1	BKUR6ET-10	90599		
SLK200	R170	2000	2001->	4	M111.958	1	IFR6D-10	5344	BKR6E-11	94306
SLK200	R171	1800	2004->2006	4	M271.944	0,8	ILFR6A	3588	LF6A-11	3672
SLK200	R171	1800	2006->2010	4	M271.944	0,8	PLKR7B-8E	94716		
SLK200	R172	1800	2011->	4	M271.861	0,8	PLKR7B-8E	94716		
SLK230	R170	2300	1997->2000	4	M111.973	0,8	BKR6E	97737		
SLK230	R170 K	2300	2000->	4	M111.983	1	IFR6D-10	5344	BKR6E-11	94306
SLK250	R172	1800	2011->	4	M271.861	0,8	PLKR7B-8E	94716		
SLK250	W172	1800	2012->	4	OM651.980		CZ303	9970		
SLK32	R170 K	3200	2001->	6	M112.960	1	IFR6D-10	5344	BKR6E-11	94306
SLK320	R170	3200	2001->	6	M112.947	1,1	PFR5R-11	4292	BKR5E-11	93674
SLK350	R171	3500	2007->	6	M272.963	0,8	PLKR7A	4288		
SLK350	R172	3500	2011->	6	M276.956	0,7	SILZKR7A-S	7718		
SLK55	R171 AMG	5500	2004->2007	8	M113.989	1	IFR6D-10	5344	BKR6E-11	94306
SLK55	R172	5500	2011->	8	M152.980	0,7	SILZKR7A-S	7718		
SLR MC LAREN	R199	5400	2006->	8	M155.980	0,8	ILFR6A	3588	LF6A-11	3672
SPRINTER	308 D	2300	1995->2000	4	OM 601		Y-916J	4454		
SPRINTER	312 D	2900	1995->	5	OM602.980.10 DELA 9849		Y-924J	3473		
SPRINTER	312 D	2900	1995->2000	5	OM602.980.12 DELA 137 ->		Y-929U	6003		
SPRINTER	313 CDI	2100	2000->	4	OM611.981		Y-745U	4705		
SPRINTER	313 CDI	2200	2011->	4	OM651.955		CZ303	9970		
SPRINTER	316 CDI	2700	2000->	4	OM612		Y-745U	4705		
SPRINTER	412 D	2900	1995->	5	OM602.980.12 DELA 136		Y-924J	3473		
SPRINTER	412 D	2900	1995->	5	OM602.980.12 DELA 137 ->		Y-929U	6003		
SPRINTER	413 CDI	2200	2000->	4	OM611.981		Y-745U	4705		
SPRINTER	416 CDI	2700	2000->	4	OM612		Y-745U	4705		
SPRINTER	518 CDI	3000	2006->	6	OM 642		Y8002AS	6286		



CAR • SUV • LCV

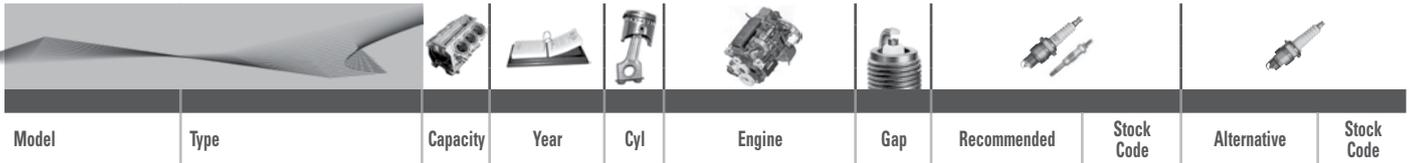

Model	Type	Capacity	Year	Cyl	Engine	Gap	Recommended	Stock Code	Alternative	Stock Code
MERCEDES BENZ										
SPRINTER	519 CDI	3000	2009->	6	OM 642		Y8002AS	6286		
V 220	220 CDI	2200	1999->	4	OM 611.980		Y-745U	4705		
V 230	230 TD	2300	1996->	4	OM 601.970		Y-916J	4454		
V 280	2.8 VR6	2800	2005->	6	M104.900	0,8	BKR5EKUP	2890	BKR5EKU	3964
VIANO	220 CDI	2200	2003->	4	M646.983		Y-745U	4705		
VIANO	2.2 CDI	2200	2010->	4	OM651.940		CZ303	9970		
VIANO	3.0 CDI	3000	2005->2010	6	OM642.990		Y8002AS	6286		
VIANO	W639 3.0 CDI	3000	2010->2010	6	OM642.990		Y8002AS	6286		
VIANO	W639 3.5 I	3500	2007->	6	M272.979	0,8	PLKR7A	4288	LKR7B-9	5847
VITO	111 CDI	1600	2014->	4	OM626.951		Y1010AS	97618		
VITO	112 CDI	2200	2001->2004	4	OM611.980		Y-745U	4705		
VITO	113 CDI	2200	2010->	4	OM641.940		CZ303	9970		
VITO	114 I	2300	1996->2003	4	M111.978	1	BKUR5ETC-10	90531		
VITO	115 CDI	2200	2004->	4	M646		Y-745U	4705		
VITO	116 CDI	2200	2010->	4	OM651.940		CZ303	9970		
VITO	122 CDI	3000	2010->	6	OM642.990		Y8002AS	6286		

MG										
MG 3	1.5 I	1500	2013->	4		0,8	BKR6EIX	6418		
MG6	1.8 T	1800	2012->	4	18 K4K	0,8	BKR6EIX	6418		
TF-SERIES	1.2 I K - SERIES	1800	2003->	4		1,1	PFR6N-11	3546	BKR6E-11	94306
TF-SERIES	1.6 I	1800	2003->	4		1,1	PFR6N-11	3546	BKR6E-11	94306
TF-SERIES	1.8 I	1800	2003->	4	18K4K	1,1	PFR6N-11	3546	BKR6E-11	94306
TF-SERIES	1.8 I K - SERIES	1800	2002->	4	18K4K	1,1	PFR6N-11	3546	BKR6E-11	94306
ZR-SERIES	1.2 L	1800	2003->	4	K	1,1	PFR6N-11	3546	BKR6E-11	94306
ZR-SERIES	1.6 S	1800	2003->	4	K VVC	1,1	PFR6N-11	3546	BKR6E-11	94306
ZR-SERIES	2.0 TD	2000	2003->	4			Y-730U	2273		
ZS180	2.5 SX	2500	2001->	6	25K4F	1,1	PFR6N-11	3546	BKR6E-11	94306
ZT-SERIES	190	2500	2003->	6	25K4F	1,1	PFR6N-11	3546	BKR6E-11	94306
ZT-SERIES	1.6 TURBO	1800	2003->	4	K	1,1	PFR6N-11	3546	BKR6E-11	94306

MINI										
CLUBMAN COOPER S	2.0 T	2000	2015->	4	B46A 20A	0,8	SILZKGR8B8S	94201		
COUNTRYMAN	1.6 COUNTRYMAN S	1600	2012->	4	N18B16C	0,8	PLZKBR7B8G			
COUNTRYMAN	1.6 T	1600	2010->	4	N16B16A	0,8	PLZKBR7B8G			
COUNTRYMAN S	2.0 T	2000	2016->	4	B46A 20A	0,8	SILZKGR8B8S	94201		
COUNTRYMAN S	2.0 T	2000	2016->	4	B46A 20A	0,8	SILZKGR8B8S	94201		
COUNTRYMAN S	2.0 T	2000	2016->	4	B48A 20A	0,8	SILZKGR8B8S	94201		
MINI CLUBMAN	1.5 I	1500	2015->	4	B36A 15A	0,8	SILZKGR8B8S	94201		
MINI CLUBMAN ONE	1.6 D	1600	2010->	4	N47 C16A		Y1039AS	91848		
MINI COOPER	1.6 CVT	1600	2002->	4	W10 B16A	0,8	BKR6EQUP	3199	BKR6EQUA	6872
MINI COOPER	1.6 GDI, TURBO	1600	2007->	4	N14 B16	0,8	ILZKBR7B8G			
MINI COOPER	1.6 S 16V	1600	2003->	4	W11 B16A	0,8	BKR6EQUP	3199	BKR6EQUA	6872
MINI COOPER	1.6 S 16V JCW	1600	2005->	4	W11 B16A	0,8	BKR7EQUP	4285	BKR7EQUA	5881
MINI COOPER CLUBMAN	1.6 D	1600	2010->	4	N47 C16A		Y1039AS	91848		
MINI COOPER CLUBMAN	2.0 D	2000	2011->	4	N47 C20A		Y1039AS	91848		
MINI COOPER CLUBMAN S	2.0 D	2000	2011->	4	N47 C20A		Y1039AS	91848		
MINI COOPER CLUBMAN S	2.0 D	2000	2011->	4	N47 C20A		Y1039AS	91848		
MINI COOPER S	1.6 SUPER CHARGED	1600	2002->2007	4	W11 B16A	0,8	BKR6EQUP	3199	BKR6EQUA	6872
MINI COOPER S	1.6 TURBO	1600	2008->	4	N14 B16A	0,8	PLZKBR7B8G			
MINI COOPER S	2.0 T	2000	2013->	4	B46A 20A	0,8	SILZKGR8B8S	94201		
MINI COOPER S	2.0 T	2000	2013->	4	B46A 20A	0,8	SILZKGR8B8S	94201		
MINI COOPER WORKS	1.6 SUPERCHARGED	1600	2003->2007	4	W11 B16A	0,8	BKR7EQUP	4285	BKR7EQUA	5881
MINI COOPER WORKS	2.0 T	2000	2015->	4	B48A 20 B	0,8	SILZKGR8B8S	94201		
MINI ONE	1.4 MINI ONE	1400	2007->	4	N12 B14A	0,8	PLZKBR7B8G			
MINI ONE	1.6 MINI ONE	1600	2010->	4	N16 B16A	0,8	PLZKBR7B8G			
PACEMAN	1.6 I	1600	2012->	4	N16 B16A	0,8	PLZKBR7B8G			
PACEMAN	1.6 T ALL 4 WORKS	1600	2013->	4	N18B16C	0,8	PLZKBR7B8G			
PACEMAN	1.6 Y PACEMAN S	1600	2013->	4	N18B16A	0,8	PLZKBR7B8G			

MITSUBISHI										
ASX	2.0 I	2000	2011->	4	4B11	0,8	FR6EI	2687		
COLT	1.6 L	1600	1994->1998	4	4G32	0,8	BPR6ES	96989		
COLT	2.0 I	2000	1998->	4	4G63	0,8	BPR6ES	96989		
COLT	2.0 L	2000	1994->1998	4	4G63	0,8	BPR6ES	96989		
COLT	2.4 I HI-LINE	2400	1998->	4	4G64	0,8	BKR5E	92870		
COLT	2.5 D	2500	1986->	4	4D56		Y-115T-1	2189		
COLT	2.5 TD	2500	1993->1998	4	4D56T		CZ257	96868		
COLT	2.5 TD	2500	1993->1999	4	4D56T		Y-733J	8944		

MERCEDES BENZ



CAR • SUV • LCV



Model	Type	Capacity	Year	Cyl	Engine	Gap	Recommended	Stock Code	Alternative	Stock Code
MITSUBISHI										
COLT	2.6 SE	2600	1995->	4	4G54	0,8	BPR5ES	94084		
COLT	2.8 CLUB CAB	2800	1994->2000	4	4M40		CZ256	90066		
COLT	2.8 TD	2800	2001->	4	4M40T		CZ256	90066		
COLT	3.0 V6	3000	1994->1997	6	6G72	1,1	BPR5ES-11	4424		
COLT	3.0 V6	3000	1998->	6	6G72	1,1	PFR6G-11	5555	BKR6E-11	94306
COLT GALANT	1.6 GL	1600	1977->1984	4	4G32	0,8	BPR5ES	94084		
COLT GALANT	2.0 GLX	2000	1977->1984	4	4G52	0,8	BPR5ES	94084		
COLT GALANT	2.6 L	2600	1979->1984	4	4G54	0,8	BPR5ES	94084		
ECLIPSE	ECLIPSE CROSS	1499	2018->	4	4B40	0,8	SILKR7H8			
GALANT	2.4 GDI	2400	2001->2007	4	4G64	0,8	BKR6EKUC	1013		
GT	3.0 GT V6	3000	1999->	6		1,1	PFR6J-11	2743	BKR6E-11	94306
L 300	1.6 H	1600	1982->1985	4	4G32	0,8	BPR5ES	94084		
L 300	1.8 H	1800	1983->1987	4	4G62	0,8	BPR6ES	96989		
L 300	2.0 LWB, HI	2000	1987->	4	4G63	0,8	BPR6ES	96989		
L 300	2.0 STAR WAGON	2000	1985->1995	4	4G63	0,8	BPR6ES	96989		
L 300	2.5 D	2500	1992->	4	4D5/5		Y-115T-1	2189		
L 300	2.5 D	2500	1997->	4	4D56		Y-733J	8944		
L300	2.5 TD	2500	1993->1996	4	4D56 SOHC		CZ257	96868		
LANCER	1.5 I SPORTBACK	1500	2008->	4	4A91	1,1	ILZFR6C-11K	4673	ILZFR6C-K	6645
LANCER	1.6 GLX	1600	2003->	4	4G18	1,1	BKR5E-11	93674		
LANCER	2.0 VVT	2000	2006->2008	4	4B11TC	0,8	ILFR7H	5245	LFR7A	92038
LANCER	2.0 EVO 10	2000	2008->2010	4	4B11 TC	0,6	ILKR8E-6	1422		
LANCER	2.0 EVO 6 TURBO	2000	2004->	4	4G63	0,8	IGR7A-G	3106	BPR7ES	95164
LANCER	2.0 EVO 7	2000	2001->	4	4G63	0,8	IGR7A-G	3106	BPR7ES	95164
LANCER	2.0 EVO 8	2000	2006->	4	4G63 CT9A	0,8	IGR7A-G	3106	BPR7ES	95164
LANCER	2.0 EVO 9	2000	2006->2007	4	4G63	0,8	ILFR7H	5245	LFR7A	92038
MIRAGE	1.2 I	1200	2014->	3	3A92	1,1	LZFR5B1-11	93298		
OUTLANDER	2.4 GLS	2400	2012->	4	4B12	1	IFR5N-10	7866	BKR5E-11	93674
OUTLANDER	2.4 I	2400	2003->	4	4G69	0,8	LZFR6AI	3656	LFR6A-11	3672
OUTLANDER	2.4 I	2400	2007->	4	4B12	0,8	FR5EI	1313		
OUTLANDER	2.4 SE	2400	2009->	4	4B12	0,8	FR6EI	2687		
OUTLANDER	3.0 XLS	3000	2009->	6	6B31 FI	0,8	ILKR7B-8	1989		
PAJERO	1.6 I	1600	1999->2002	4	4G18	0,8	BKR6E	97737		
PAJERO	1.8 I	1800	1999->2002	4	4G93	0,8	BKR6E	97737		
PAJERO	2.0 I	2000	2000->	4	4G94	0,6	IZFR5B	4080	PZFR5B	6584
PAJERO	2.5 TD INTERCOOLER	2500	1987->1990	4	4D56 T		Y-733J	8944		
PAJERO	2.8 V4	2800	1994->2000	4	4M40		CZ256	90066		
PAJERO	3.0 GLS V6	3000	1989->1992	6	6G72	1,1	BPR5ES-11	4424		
PAJERO	3.0 I	3000	1993->2000	6	6G72	1,1	PFR6J-11	2743	BKR6E-11	94306
PAJERO	3.2 DID	3200	2007->	4	4M41		CZ251	91190		
PAJERO	3.2 DID	3200	2007->	4	4M41		CZ251	91190		
PAJERO	3.2 DID	3200	2012->	4	4M41		CZ251	91190		
PAJERO	3.5 GLS V6	3500	1995->2000	6	6G74	1,1	PFR6J-11	2743	BKR6E-11	94306
PAJERO	3.5 GLS V6	3500	2000->2004	6	6G74	1,1	PFR6J-11	2743	BKR6E-11	94306
PAJERO	3.8 V6	3800	2007->	6	6G75	0,8	IFR6B-K	4867		
PAJERO CLASSIC	3.2 DID	3200	2005->	4	4M41		Y-1007J	8902		
PAJERO SPORT	2.5 DID	2500	2012->	4	4D56HP		CZ251	91190		
SHOGUN	2.5 TD	2500	1996->2000	4	4D56		Y-733J	8944		
SHOGUN	3.0 I	3000	1991->1994	6	6G72	1,1	BPR5ES-11	4424		
SHOGUN	3.0 I	3000	1994->	6	6G72	1,1	PFR6J-11	2743	BKR6E-11	94306
SHOGUN	3.5 I	3500	2000->2009	6	6G74	0,6	PZFR5B	6584		
SPACE	1.9 DI-D STAR	1900	2000->	4	DCI RENAULT		Y-732J	5909		
SPACE	2.0 RUNNER	2000	1993->	4	4D68		CZ257	96868		
SPACE	2.0 WAGON	2000	1995->1996	4	4D68		Y-733J	8944		
SPACE	2.5 GEAR	2500	1994->2007	4	4D56		CZ257	96868		
SPACE	2.5 GEAR	2500	1995->1997	4	4D56		CZ257	96868		
SPACE	2.5 GEAR TURBO	2500	1998->	4	4D56		Y-733J	8944		
SPACE GEAR	2.4 GLX	2400		4		1,1	BKR5E-11	93674		
TREDIA	1.4 S	1400	1983->1986	4	4G12	0,8	BPR5ES	94084		
TREDIA	1.6 SL	1600	1983->1986	4	4G32	0,8	BPR5ES	94084		
TREDIA	1.8 SL,SLX	1800	1983->1986	4	4G62	0,8	BPR5ES	94084		
TREDIA	1.8 VORTEX,TURBO	1800	1984->1986	4	4G62	0,8	B7ES	1111	BR7ES	5122
TRITON	2.4 GL	2400	2013->	4	4G64	0,6	IZFR5B	4080		
TRITON	2.4 I	2400	2006->	4	4G64	1,1	BKR5E-11	93674		
TRITON	2.5 DID	2500	2007->	4	4D56		CZ251	91190		
TRITON	3.2 DID	3200	2009->	4	4M41		CZ251	91190		
TRITON	3.5 I	3500	2011->	6	6G74	1,1	PFR5J-11	4642	BKR5E-11	93674

MITSUBISHI



CAR • SUV • LCV



Model	Type	Capacity	Year	Cyl	Engine	Gap	Recommended	Stock Code	Alternative	Stock Code
MORGAN										
4-APR	1.8 L	1800	2002>	4	FORD ZETEC	1,3	PTR5A-13	2467	TR5B-13	97667
AERO 8	4.4 L	4400	2003>	8	BMW M62B44	0,8	BKR6EQU	3199	BKR6EQUA	6872
4	2.0 L	2000	2002>	4	ROVER T16	0,8	BKR6E	97737		
NISSAN										
1 TONNER	1.6 K	1600	1988>1999	4	L16	0,8	BPR5ES	94084		
1 TONNER	1.8 S	1800	1988>1995	4	L18	0,8	BPR6ES	96989		
1 TONNER	2.4 L	2400	1988>1999	4	Z24	0,8	BPR6ES	96989		
1 TONNER	2.5 D	2500	1988>1996	6	TD25		Y-707RS	4937		
1 TONNER	2.7 D	2700	1990>1996	4	TD 27		Y-707RS	4937		
1 TONNER	3.0 TD 16V	3000	2002>	4	ZD30		CZ258	95173		
1 TONNER	3.0 V6	3000	1990>2002	6	VG30E	0,8	BKR6EY	91756		
120	1.2 Y - DL,SDX	1200	1972>1980	4	A12	0,8	BPR5ES	94084		
1200	1.2 H	1200	1977>1980	4	A12	0,8	BPR5ES	94084		
140	1.4 Y - GX	1400	1975>	4	L14	0,8	BPR5ES	94084		
140	1.4 Y - SDX	1400	1975>	4	A14	0,8	BPR5ES	94084		
1400	1.4 L	1400	1980>	4	A14	0,8	BPR5ES	94084		
160	1.6 Z - COUPE	1600	1975>	4	L16	0,8	BPR5ES	94084		
160J	1.6 Y - GX COUPE	1600	1980>	4	L16	0,8	BPR5ES	94084		
1800	1.8 KINGCAB 4 X4	1800	1980>	4	L18	0,8	BPR6ES	96989		
1800J	1.8 J GL,SSS	1800	1972>	4	L18T	0,8	BPR6ES	96989		
1800J	1.8 J SNG CARB	1800	1972>	4	L18S	0,8	BPR6ES	96989		
200SX	1.8 TURBO	1800	1991>1995	4	CA18DET	1,1	BCPR6ES-11	90010		
200SX	2.0 TURBO	2000	1997>	4	SR20DET	0,9	PFR6B-9	3100	BKR6E	97737
2200	2.2 TRACKER 4 X4	2200	1982>1983	4	Z22	0,8	BPR6ES	96989		
280ZX	2.8 ZX	2800	1981>1983	6	L28E	1,1	BP6ES-11	1212	BPR6ES-11	94967
300ZX	3.0 NON TURBO	3000	1984>1989	6	VG30E	1,1	BCPR6ES-11	90010		
300ZX	3.0 TURBO	3000	1990>	6	VG30ET	1,1	BCPR6ES-11	90010		
350Z	3.5 ROADSTER	3500	2005>2008	6	VQ35HR	1,1	DF7H-11B	1317		
350Z	3.5 ROADSTER	3500	2006>	6	VQ35DE	1,1	PLFR5A-11	6240	LF5A-11	95304
370Z	3.7 V6	3700	2009>	6	VQ37VHR	1,1	DF8H-11B	1305		
620	2.2 DATSUN	2200	1986>	6	Z22	0,8	BPR6ES	96989		
720	1.8 LCV	1800	1988>	4	L18	0,8	BPR5ES	94084		
ALMERA	1.5 DCI	1500	2010>	4	K9K		Y-1035AS	96614		
ALMERA	1.5 I	1500	2013>	4	HR15DE	1,1	PLZKAR6A-11	5118	LZKAR6C-11	96343
ALMERA	1.5 I	1500	2002>	4	QG15DE	1,1	LF5A-11	95304		
ALMERA	1.6 16V	1600	2001>	4	QG16DE	1,1	BKR5E-11	93674		
ALMERA	1.6 16V	1600	2011>	4	HR16DE	1,1	LZKAR6AP-11	6643	LZKAR6C-11	96343
ALMERA	1.8 16V	1800	2000>2003	4	QG18DE	1,1	BKR6E-11	94306		
ALMERA	1.8 16V	1800	2010>	4	MR18DE	1,1	LZKAR6AP-11	6643	LZKAR6C-11	96343
ALMERA	1.8 I	1800	2013>	4	MR18DE	1,1	LZKAR6AP-11	6643	LZKAR6C-11	96343
ARMADA	5.6 V8	5600	2007>	8	VK56DE	1,1	PLFR5A-11	6240	LF5A-11	95304
E20	1.8 EKONOVAN	1800	1981>1996	4	L18	0,8	BPR6ES	96989		
E20	2.0 EKONOBUS	2000	1973>1981	4	H20	0,8	BPR6ES	96989		
ECONOBUS	1.8 BUS,LCV	1800	1986>	4	L18	0,8	BPR6ES	96989		
GT-R	3.8 I	3800	2009>	6	VR38DETT	0,8	DILKAR8A-8	93026	LKAR8A-9	4786
HARDBODY	1.6 I	1600	1999>2002	4	NA16	0,8	BPR6ES	96989		
HARDBODY	2.0 I	2000	1999>2002	4	NA20	0,8	BPR6ES	96989		
HARDBODY	2.0 I 16V	2000	2002>	4	KA20DE	1,1	BKR6E-11	94306		
HARDBODY	2.4 12V	2400	2002>	4	KA24E	1,1	BKR5E-11	93674		
HARDBODY	2.4 16V	2400	1999>2002	4	Z24	0,8	BPR6ES	96989		
HARDBODY	2.4 16V	2400	2003>	4	KA24	1,1	BKR5E-11	93674		
HARDBODY	2.4 I	2400	2001>	4	KA24E	1,1	ZFR5F-11	93814		
HARDBODY	2.7 D	2700	1996>2002	6	TD27		Y-707RS	4937		
HARDBODY	3.0 I V6	3000	1999>2002	6	VG30E	0,8	BKR6E	97737		
HARDBODY	3.0 TD	3000	2000>2006	6	ZD30DDTI		CZ258	95173		
HARDBODY	3.2 D	3200	1999>2003	6	QD32		Y-707RS	4937		
HARDBODY	3.3 I	3300	2002>	6	VG33E	1,1	BKR6E-11	94306		
INFINITI	4.5 V8	4500	1995>	8	VH45DE	1,1	BKR6ES-11	94437		
INTERSTAR	2.5 DCI	2500	2006>	4	G9U754		Y-517J	3319		
JUKE	1.2 T	1200	2014>	4	HRA2DDT	0,7	ILKAR7F7G	90061		
JUKE	1.5 DCI	1500	2010>	4	K9K		Y-1035AS	96614		
JUKE	1.6 16V	1600	2011>	4	HR16DE	1,1	DILZKAR6A11	91691		
JUKE	1.6 I	1600	2013>	4	HR16DE	1,1	DILZKAR6A11	91691		
JUKE	1.6 TURBO	1600	2012>	4	MR16DDT	0,9	DILKAR7C-9H	91215		
LANGLEY	1.3 GL	1300	1986>1987	4	E13	0,8	BPR5ES	94084		
LANGLEY	1.5 EXA TURBO,SSS,TREBON	1500	1984>1987	4	E15T	0,8	BPR6ES	96989		
LANGLEY	1.5 GL,L,SGL	1500	1983>1987	4	E15	0,8	BPR6ES	96989		
LAUREL	2.0 G	2000	1980>1983	4	L20	0,8	BPR6ES	96989		
LAUREL	2.8 GL,L	2800	1978>1985	6	L28 (CARB)	0,8	BPR6ES	96989		
LAUREL	2.8 SGL	2800	1986>1987	6	L28E FUEL INJ	1,1	BP6ES-11	1212	BPR6ES-11	94967

MORGAN



CAR • SUV • LCV



Model	Type	Capacity	Year	Cyl	Engine	Gap	Recommended	Stock Code	Alternative	Stock Code
NISSAN										
LIVINA	1.6 I	1600	2007->	4	L10	1,1	LZKAR6AP-11	6643	LZKAR6C-11	96343
MAXIMA	2.0 QX	2000	1997->	6	VQ20DE	1,1	PFR6G-11	5555	BKR6E-11	94306
MAXIMA	3.0 E,SE	3000	1991->1996	6	VG30E	1,1	BKR6ES-11	94437		
MAXIMA	3.0 QX	3000	2000->	6	VQ30DE	1,1	PFR6G-11	5555	BKR6E-11	94306
MICRA	1.2 I	1200	2011->	3	HR12DE	1,1	LZKAR6C-11	96343		
MICRA	1.4 K12	1400	2005->	4	CR14DE	1,1	LF5E-11	1669	LF5A-11	95304
MICRA	1.5 DCI K12	1500	2003->	4	K9K		Y-732J	5909		
MICRA	1.5 TEKNA	1500	2011->	4	HR15DE	1,1	PLZKAR6A-11	5118	LZKAR6C-11	96343
MICRA	1.6 SR160	1600	2007->	4	HR16DE	1,1	PLZKAR6A-11	5118	LZKAR6C-11	96343
MURANO	3.5 I	3500	2002->2007	6	VQ35DE	1,1	PLFR5A-11	6240	LF5A-11	95304
MURANO	3.5 I V6	3500	2010->	6	VQ35DE	1,1	DF7H-11B	1317		
NAVARA	2.5 DCI	2500	2005->	4	YD25D		Y-519J	2500		
NAVARA	2.5 DCI	2500	2005->	4	YD25DDTI		Y1010AS	97618		
NAVARA	2.5 DCI	2500	2008->	4	YD25D		Y-519J	2500		
NAVARA	2.5 I	2500	2007->	4	QR25DE	1,1	DILKAR6A-11	9029	PLZKAR6A-11	5118
NAVARA	2.5 TD	2500	2002->	4	TD25TI		CZ261	97009		
NAVARA	4.0 I	4000	2005->	6	VQ40DE	1,1	PLFR5A-11	6240	LF5A-11	95304
NOTE	1.6 I	1600	2006->	4	HR16DE	1,1	PLZKAR6A-11	5118	LZKAR6C-11	96343
NOTE 2	1.5 DCI	1500	2013->	4	K9K		Y-1035AS	96614		
NP200	1.5 DCI	1500	2010->	4	K9K		Y-732J	5909		
NP200	1.6 16V	1600	2008->	4	K7MF F11L	0,8	BKR6EK	94007		
NP200	1.6 8V	1600	2008->	4	K4M	0,8	BKR6EZ	4619		
NP300	2.0 I	2000	2001->	4	KA20DE	1,1	BKR5E-11	93674		
NP300	2.4 4X4, 4X2	2400	1999->	4	KA24	1,1	BKR5E-11	93674		
NP300	2.4 I	2400	2001->	4	KA24DE	1,1	BKR5E-11	93674		
NP300	2.5 TD	2500	2009->	4	YD25D		Y-519J	2500		
NP300	2.5 TDI	2500	2010->	4	YD25DDTI		Y1010AS	97618		
NV200	1.5 DCI	1500	2011->	4	K9K		Y-1035AS	96614		
NV200	1.5 DCI	1500	2011->	4	K9K		Y-1035AS	96614		
NV200	1.6 16V	1600	2010->	4	HR16DE	1,1	PLZKAR6A-11	5118	LZKAR6C-11	96343
NV350	2.5 D	2500	2013->	4	YD25DDTI		Y-519J	2500		
NV350	2.5 I	2500	2014->	4	QR25DE	1,1	DILKAR6A-11	9029	PLZKAR6A-11	5118
PATHFINDER	2.5 D	2500	1993->	4	VD25DDTI		Y-707RS	4937		
PATHFINDER	2.5 D	2500	2005->	4	Y25DDTI		Y-519J	2500		
PATHFINDER	4.0 I	4000	2005->	6	VQ40DE	1,1	PLFR5A-11	6240	LF5A-11	95304
PATROL	2.8 D	2800	1998->	6	RD28		CX51	2896		
PATROL	2.8 D	2800	1998->	6	RD28T		CX51	2896		
PATROL	3.0 DI	3000	2000->2006	6	ZD30DDTI		CZ258	95173		
PATROL	3.0 DTI	3000	2012->	4	ZD30D		Y-538J	93079		
PATROL	4.0 I	4000	1974->1980	6	P40	0,8	BPR6ES	96989		
PATROL	4.2 12V TD	4200	1998->2002	6	TD42		Y-707RS	4937		
PATROL	4.2 I	4200	1994->	6	TB42E	0,8	BPR6ES	96989		
PATROL	4.5 I	4500	1998->	6	TB45E	1,1	BPR6ES-11	94967		
PATROL	4.8 I	4800	2004->	6	TB48DE	1,1	LF6A-11	3672		
PICK-UP	2.3 D	2300	1984->1986	4	SD23		Y-112M-1	2531		
PICK-UP	2.4 I	2400	2002->	4	KA24E	1,1	ZFR5F-11	93814		
PICK-UP	2.5 D	2500	1984->1986	4	SD25		Y-112M-1	2531		
PICK-UP	2.7 TD	2700	1998->	4	TD27T		Y-712RS	6140		
PRIMASTAR	1.9 DCI	1900	2001->	4			Y-732J	5909		
PRIMERA	1.6 SI	1600	1998->2000	4	GA16E	1,1	BKR5E-11	93674		
PRIMERA	2.0 SI, GSI, STI	2000	1998->	4	SR20DE	1,1	BKR6EY-11	93888		
PULSAR	1.3 S	1300	1983->1986	4	E13	0,8	BPR5ES	94084		
PULSAR	1.4 GX, DL	1400	1980->1984	4	A14	0,8	BPR5ES	94084		
PULSAR	1.5 GL, SX, PANACHE	1500	1982->1987	4	E15	0,8	BPR6ES	96989		
QASHQAI	1.2 T	1200	2013->	4	HR12DDT	0,7	ILKAR7F7G	90061		
QASHQAI	1.5 DCI	1500	2010->	4	K9K		Y-1035AS	96614		
QASHQAI	1.5 DCI	1500	2013->	4	K9K		Y-1035AS	96614		
QASHQAI	1.6 DCI	1600	2013->	4	R9M		Y1010AS	97618		
QASHQAI	1.6 I	1600	2007->	4	HR16DE	1,1	PLZKAR6A-11	5118	LZKAR6AP-11	6643
QASHQAI	2.0 DCI	2000	2007->2014	4	M9R		CZ167	91063		
QASHQAI	2.0 I	2000	2007->	4	MR20DE	1,1	LZKAR6AP-11	6643	LZKAR6C-11	96343
SABRE	1.6 GX, GXI	1600	1994->1997	4	GA16E	0,8	BKR6E	97737		
SABRE	2.0 GXI	2000	1994->2000	4	SR20DE	0,8	BKR6E	97737		
SAFARI	2.8 I	2800	1982->1990	6	L28	0,8	BPR6ES	96989		
SANI	2.4 L	2400	1998->1999	4	Z24	0,8	BPR6ES	96989		
SANI	2.7 TD	2700	1998->1999	4	TD27		Y-707RS	4937		
SANI	3.0 V6	3000	1998->1999	6	VG30E	0,8	BKR6E	97737		
SENTRA	1.3 GL	1300	1987->1992	4	E13S	0,8	BPR5ES	94084		
SENTRA	1.3 SX	1300	1987->1992	4	L13S	0,8	BPR5ES	94084		
SENTRA	1.4 DEBUT	1400	1992->1997	4	GA14DS	0,8	BKR6E	97737		
SENTRA	1.4 GX, I, SI, GXI	1400	1992->1997	4	GA14DS	0,8	BKR6E	97737		
SENTRA	1.6 GL, GX	1600	1987->1992	4	E16S	0,8	BPR6ES	96989		



CAR • SUV • LCV



Model	Type	Capacity	Year	Cyl	Engine	Gap	Recommended	Stock Code	Alternative	Stock Code
NISSAN										
SENTRA	1.6 GX	1600	1992->1997	4	GA16DS	0,8	BKR5E	92870		
SENTRA	1.6 GXEI,SGLI	1600	1987->1992	4	E16E	0,8	BPR6ES	96989		
SENTRA	1.6 I	1600	2013->	4	HR16DE	1,1	LZKAR6AP-11	6643	LZKAR6C-11	96343
SENTRA	1.6 SE,SI,GS1,GXI	1600	1992->1996	4	GA16E	0,8	BKR6E	97737		
SENTRA	1.6 SI,GS1,GXI	1600	1997->2000	4	GA16DNE	0,8	BKR6E	97737		
SENTRA	1.6 TURBO	1600	2017->	4	MR16DDT	0,9	DILKAR7C-9H	91215		
SENTRA	1.8 16V EX	1800	1989->1992	4	CA18DE	1,1	BCPR6ES-11	90010		
SENTRA	1.8 I	1800	2013->	4	MRA18DE	1,1	LZKAR6AP-11	6643	LZKAR6C-11	96343
SENTRA	2.0 I	2000	2013->	4	MR20DE	1,1	LZKAR6AP-11	6643	LZKAR6C-11	96343
SENTRA	2.0 STI,GS1	2000	1992->1997	4	SR20DE	0,8	BKR6E	97737		
SERENA	2.3 D	2300	1998->	4	LD23		Y-530J	6586		
SKYLINE	1.8 L	1800	1982->1987	4	L18	0,8	BPR6ES	96989		
SKYLINE	2.0 GL	2000	1982->1987	4	L20B	0,8	BPR6ES	96989		
SKYLINE	2.0 GL,GLE	2000	1987->1992	4	CA20S	0,8	BCP6ES	94000	BCP6ES	96990
SKYLINE	2.0 SGLI	2000	1987->	4	RB20E	1,1	BKR5E-11	93674		
SKYLINE	2.8 D	2800	1955->1956	4	LD28		Y-204-TS-1	3829		
SKYLINE	2.8 GTX,SGLI	2800	1982->1987	6	L28E	1,1	BP6ES-11	1212	BPR6ES-11	94967
SKYLINE	2.8 GT,GLX,SGL	2800	1983->1986	6	L28H	0,8	BPR6ES	96989		
SKYLINE	3.0 SGLI	3000	1987->1992	6	RB30E	1,1	BCPR6ES-11	90010		
SKYLINE	3.8 GT-R	3800	2012->	6	VR38DETT	0,8	DILKAR8A-8	93026	LKAR8A-9	4786
STANZA	1.6 S	1600	1978->1983	4	L16S	0,8	BPR5ES	94084		
STANZA	1.8 SSS,GL	1800	1978->1983	4	L18,T,S	0,8	BPR6ES	96989		
STANZA DL	1.6 S	1600	1978->1983	4	L16S OHC	0,8	BPR5ES	94084		
STANZA GL	1.8 L	1800	1978->1983	4	L18T	0,8	BPR6ES	96989		
TERRANO 1	2.4 I	2400	1997->2001	6	KAZ4E	1,1	ZFR5F-11	93814		
TERRANO 1	2.7 TDI	2700	1998->	4	TD27		Y-707RS	4937		
TERRANO 2	2.7 TDI	2700	1993->	4	TD27T		Y-712RS	6140		
TERRANO 2	2.7 TDI	2700	1999->2003	4	TD27TI		CZ261	97009		
TERRANO 2	3.0 DTI	3000	2003->	6	ZD30DDTI		CZ258	95173		
THIDA	1.6 I	1600	2008->	4	HR16DE	1,1	PLZKAR6A-11	5118	LZKAR6C-11	96343
THIDA	1.8 I	1800	2008->	4	MR18DE	1,1	PLZKAR6A-11	5118	LZKAR6C-11	96343
X-TRAIL	1.6 DCI	1600	2013->	4	R9M		Y1010AS	97618		
X-TRAIL	2.0 DCI	2000	2007->2014	4	M9R		CZ167	91063		
X-TRAIL	2.0 I	2000	2001->	4	QR20DE	1,1	LFRA5A-11	95304		
X-TRAIL	2.0 I	2000	2007->	4	MR20DE	1,1	PLZKAR6A-11	5118	LZKAR6AP-11	6643
X-TRAIL	2.0 T32 20X 2WD	2000	2014->	4	MR20DD	1,1	DILKAR7D11H			
X-TRAIL	2.2 D	2200	2001->	4	YD22ET		Y-519J	2500		
X-TRAIL	2.5 I	2500	2002->2006	4	QR25DE	1,1	LFRA5A-11	95304		
X-TRAIL	2.5 I	2500	2007->	4	QR25DE	1,1	DILKAR6A-11	9029	PLZKAR6A-11	5118
XTERRA	4.0 I	4000	2007->	6	VQ40DE	1,1	PLFR5A-11	6240	LFRA5A-11	95304

OPEL										
ADAM	1.0 T	1000	2015->	3	B10XFL	0,7	ILNAR8B7G	91970	SILZNR8C-7H	93593
ADAM	1.0 T	1000	2015->	3	B10XFT	0,7	ILNAR8B7G	91970	SILZNR8C-7H	93593
ADAM	1.2 I	1200	2015->	3	A12XEL	0,8	ZFR6V-G	8894		
ADAM	1.4 I	1400	2015->	4	Z14XER	0,8	ZFR6V-G	8894		
ADAM	1.4 S	1400	2015->	4	B14NEH	0,8	BKR7EIX	2667	BCPR7ES	93606
ASCONA	1.3 L,GL,GLS	1300	1984->1985	4	I3SC	0,8	BPR6ES	96989		
ASCONA	1.6 GL,GLS	1600	1982->1987	4	OHC	0,8	BPR6ES	96989		
ASCONA	1.8 GLS	1800	1984->1987	4	OHC	0,8	BPR6ES	96989		
ASTRA F	1.4 I S	1400	1997->1999	4	C14SE	0,8	BKR6EK	94007		
ASTRA F	1.4 S	1400	1993->1996	4	14NV	0,8	BKR6EK	94007		
ASTRA F	1.6 I	1600	1993->1994	4	C16NZ	0,8	BPR6ES	96989		
ASTRA F	1.6 I	1600	1994->1995	4	C16NZ	0,8	BKR6EK	94007		
ASTRA F	1.6 I E	1600	1993->1998	4	C16SE	0,8	BPR6ES	96989		
ASTRA F	1.6 I E,S	1600	1995->1999	4	C16SE	0,8	BKR6EK	94007		
ASTRA F	1.8 I AT	1800	1993->1996	4	C18NZ	0,8	BPR6ES	96989		
ASTRA F	1.8 IE	1800	1996->1999	4	X18XE	0,8	BKR6EK	94007		
ASTRA F	2.0 I	2000	1993->1994	4	C20NE	0,8	BPR6ES	96989		
ASTRA F	2.0 I	2000	1995->	4	C20XE	0,8	BKR6EK	94007		
ASTRA F	2.0 I S	2000	1995->	4	X20XEV	0,8	BKR6EK	94007		
ASTRA F	2.0 I S	2000	1993->1999	4	C20NE	0,8	BPR6ES	96989		
ASTRA F	2.0 IE	2000	1993->1998	4	C20NE	0,8	BCPR6ES	96990		
ASTRA F	2.0 IE	2000	1993->1998	4	C20NE	0,8	BKR6EK	94007		
ASTRA F	2.0 ITS	2000	1994->1996	4	C20LET	0,8	BCPR6ET	2197		
ASTRA F	2.0 TS	2000	1993->1996	4	C20LET	0,8	BCPR7ET	2164		
ASTRA G	1.6 CS	1600	2004->	4	Z16XE	0,8	BKR6EK	94007		
ASTRA G	1.6 CS	1600	2004->	4	Z16XEP	1,1	ZFR5F-11	93814		
ASTRA G	1.6 CS,CD,CDE	1600	1999->	4	C16SEL	0,8	BKR5EK	90426		
ASTRA G	1.8 CDE	1800	2004->	4	Z18XE	0,8	BKR6EK	94007		
ASTRA G	1.8 CDE,CSE	1800	1999->	4	X18XE1	0,8	BKR5EK	90426		

NISSAN



CAR • SUV • LCV



Model	Type	Capacity	Year	Cyl	Engine	Gap	Recommended	Stock Code	Alternative	Stock Code
OPEL										
ASTRA G	2.0 CDX,CSX	2000	1999->	4	X20XE	0,8	BKR5EK	90426		
ASTRA G	2.0 TURBO	2000	2004->	4	Z20LET	0,8	BKR6EK	94007		
ASTRA G	2.2 CDE	2200	2001->	4	X22XE	0,8	BKR5EK	90426		
ASTRA G	2.2 CSX	2200	2002->	4	Z22SE	1,3	LTR6B-10T	5948		
ASTRA H	1.4 I	1400	2000->	4	Z14XEP	1,1	ZFR5F-11	93814		
ASTRA H	1.6 GTC TURBO	1600	2007->	4	Z16LET	1	PFR6T-G	6314	BKR6ES-11	94437
ASTRA H	1.6 I	1600	2004->	4	Z16XEP	1,1	ZFR5F-11	93814		
ASTRA H	1.6 SE	1600	2006->	4	Z16LET	0,8	ZFR6BP-G	1748		
ASTRA H	1.8 CD	1800	2006->	4	Z18XER	1,1	ZFR6F-11	93208		
ASTRA H	1.8 GTC	1800	2007->	4	Z18XE	1,1	ZFR5F-11	93814		
ASTRA H	1.9 CDTI	1900	2004->	4	Z19DT		Y-534J	5540		
ASTRA H	1.9 CDTI	1900	2006->	4	Z19DTL		YE07	6092		
ASTRA H	2.0 GTC TURBO	2000	2005->2006	4	Z20LER	1,1	ZFR6F-11	93208		
ASTRA H	2.0 OPC TURBO	2000	2005->2006	4	Z20LEH	0,8	PFR6T-G	6314	BKR6ES-11	94437
ASTRA H	2.0 TURBO	2000	2005->	4	Z20LER	0,8	ZFR6V-G	8894		
ASTRA J	1.4 I	1400	2012->2015	4	A14XER	0,7	IFR7X-7G	91039		
ASTRA J	1.4 TURBO	1400	2009->2015	4	A14NET	0,7	IFR7X-7G	91039		
ASTRA J	1.4 TURBO	1400	2010->2015	4	A14NEL	0,7	IFR7X-7G	91039		
ASTRA J	1.6 I	1600	2009->2015	4	A16XER	0,8	ZFR6V-G	8894		
ASTRA J	1.6 TURBO	1600	2009->2015	4	A16LET	0,8	ZFR6BP-G	1748		
ASTRA J	1.8 GTC	1800	2011->	4	A18XER	0,8	ZFR6V-G	8894		
ASTRA J	2.0 I 16V OPC	2000	2014->	4	A20NFT	0,8	ILTR5D	5476		
ASTRA K	1.6 T	1600	2015->	4	B16SHT	0,7	ILNAR8B7G	91970	SILZNR8C-7H	93593
CALIBRA	2.0 I	2000	1992->	4	20XEH DOHC	0,8	BCPR6ES	96990		
COMBO	1.4 I	1400	2004->	4	Z14XEP	1,1	ZFR5F-11	93814		
COMBO	1.7 DTI 16V	1700	2004->	4	Z17DTH		Y-541J	4617		
COMMODORE	2.8 E	2800	1982->1983	6	OHC	0,6	BP6HS	4511	BPR6HS	7022
COMMODORE	3.0 E	3000	1986->1988	6	OHC	0,6	BP6HS	4511	BPR6HS	7022
CORSA	1.3 I CHILL,LITE,	1300	1996->2002	4	13NE	0,8	BPR6EY	90310		
CORSA	1.3 I UTILITY PRONTO	1300	1997->2000	4	13NE	0,8	BPR6EY	90310		
CORSA	1.4 I UTILITY	1400	2000->2004	4	14NE	0,8	BPR6EY	90310		
CORSA	1.6 I S	1600	2002->	4	C16SE	0,8	BPR5EY	94270		
CORSA	1.6 I UTILITY	1600	1997->2004	4	16NE	0,8	BCPR6ES	96990		
CORSA	1.6 I, GSI	1600	1998->	4	16NE	0,8	BPR5EY	94270		
CORSA	1.7 CLASSIC	1700	2002->	4	17D 4EE1		Y-603J	4305		
CORSA	1.7 DT	1700	1994->2000	4	17D		Y-603J	4305		
CORSA	1.7 TD	1700	2006->	4	Z17DTR		Y-541J	4617		
CORSA	1.7 UTILITY	1700	1998->2004	4	17D,X17D 4EE1		Y-603J	4305		
CORSA B	1.4 I	1400	2002->	4	C14SE	0,8	BPR5EY	94270		
CORSA B	1.4 I	1400	2002->	4	C14SE	0,8	BPR5EY	94270		
CORSA C	1.4 COMBO	1400	2005->2006	4	Z14XE	0,8	BKR5EK	90426		
CORSA C	1.4 I	1400	2000->	4	Z14XE	0,8	BKR5EK	90426		
CORSA C	1.4 I	1400	2003->	4	Z14XEP	1,1	ZFR5F-11	93814		
CORSA C	1.6 I	1600	2000->	4	Z16SE	0,8	BKR5EK	90426		
CORSA C	1.7 CDTI	1700	2003->	4	Z17DTH		Y-541J	4617		
CORSA C	1.7 CDTI	1700	2004->	4	Z17DTH		Y-541J	4617		
CORSA C	1.7 CDTI UTILITY	1700	2006->	4	Z17 DTR		Y9004AS	90860		
CORSA C	1.8 I	1800	2000->	4	Z18XE	0,8	BKR5EK	90426		
CORSA C	1.8 I	1800	2002->	4	18SE	0,8	BPR5EY	94270		
CORSA C	1.8 I	1800	2000->	4	Z18XE	0,8	BKR5EK	90426		
CORSA D	1.3 CDTI	1300	2005->	4	Z13XDTH		Y9004AS	90860		
CORSA D	1.4 I	1400	2006->	4	Z14XEP	1,1	ZFR5F-11	93814		
CORSA D	1.4 I	1400	2007->	4	Z14XEP	1,1	ZFR5F-11	93814		
CORSA D	1.4 I	1400	2010->	4	A14XER	0,8	ZFR6V-G	8894		
CORSA D	1.4 UTILITY	1400	2006->	4	X14SE	1,1	ZFR5F-11	93814		
CORSA D	1.6 OPC	1600	2007->	4	Z16LER	0,8	ZFR6BP-G	1748		
CORSA D	1.6 OPC TURBO	1600	2009->	4	A16LET	0,8	ZFR6BP-G	1748		
CORSA D	1.6 T	1600	2007->	4	Z16LEL	0,8	ZFR6BP-G	1748		
CORSA D	1.6 TURBO	1600	2007->	4	Z16LET	0,8	ZFR6BP-G	1748		
CORSA D	1.7 DTI	1700	2006->	4			Y-541J	4617		
CORSA D	1.8 I	1800	2006->	4	Z18SE	0,8	BPR5EY	94270		
CORSA D	1.8 I	1800	2011->	4	C5A	0,8	BPR6EY	90310		
CORSA D	1.8 UTILITY	1800	2013->	4	X18XE	0,8	BPR6EY	90310		
CORSA E	1.2 I	1200	2014->	4	B12XEL	0,8	ZFR6V-G	8894		
CORSA E	1.4 I	1400	2014->	4	B14XEL	0,8	ZFR6V-G	8894		
CORSA E	1.4 T	1400	2014->	4	B14NEJ	0,7	IFR7X-7G	91039		
CORSA E	2.0 OPC	2000	2014->	4	A20NFT	0,8	ILTR5D	5476		
CORSA E	ECOFLEX 1.0 T	1000	2015->	3	B10XFT	0,7	ILNAR8B7G	91970	SILZNR8C-7H	
FIRENZA	1.6 L	1600	1970->1972	4		0,8	BP7FS	3612		
KADETT	1.2 L	1200	1984->1985	4	C13N	0,6	BP6HS	4511	BPR6HS	7022
KADETT	1.3 CUB, GL, LS	1300	1988->1991	4	C13N	0,8	BPR6ES	96989		
KADETT	1.3 GL	1300	1980->1985	4	NVH SOHC	0,8	BPR6ES	96989		



CAR • SUV • LCV



Model	Type	Capacity	Year	Cyl	Engine	Gap	Recommended	Stock Code	Alternative	Stock Code
OPEL										
KADETT	1.3 GLS	1300	1980->1985	4	NVH SOHC	0,8	BPR6ES	96989		
KADETT	1.3 LS	1300	1987->	4	NVH SOHC	0,8	BPR6ES	96989		
KADETT	1.4 CL	1400	1987->	4	NV SOHC	0,8	BPR6ES	96989		
KADETT	1.4 CUB	1400	1987->	4	NV SOHC	0,8	BPR6ES	96989		
KADETT	1.4 I S	1400	1995->	4	C14NZ	0,8	BKR6EK	94007		
KADETT	1.4 L	1400	1993->/1994	4	14NV SOHC	0,8	BPR6ES	96989		
KADETT	1.4 S	1400	1995->	4	14NV	0,8	BKR6EK	94007		
KADETT	1.4 S	1400	1993->1994	4	14NV SOHC	0,8	BPR6ES	96989		
KADETT	1.6 CUB	1600	1990->1993	4	C16NZ	0,8	BPR6ES	96989		
KADETT	1.6 GLS	1600	1980->1985	4	NVH	0,8	BPR6ES	96989		
KADETT	1.6 GLS	1600	1985->1985	4	SE	0,8	BPR6ES	96989		
KADETT	1.6 GLS, GL	1600	1982->	4	NVH	0,8	BPR6ES	96989		
KADETT	1.6 GSE	1600	1996->	4	C16LZ	0,8	BPR6ES	96989		
KADETT	1.6 GSE	1600	1987->	4	E16NZ	0,8	BPR6ES	96989		
KADETT	1.6 GSI	1600	1990->1991	4	SE	0,8	BPR6ES	96989		
KADETT	1.6 I	1600	1993->1994	4	16NZ SOHC	0,8	BPR6ES	96989		
KADETT	1.6 I	1600	1994->1998	4	C16NZ	0,8	BKR6EK	94007		
KADETT	1.6 I S	1600	1995->1998	4	16SE	0,8	BKR6EK	94007		
KADETT	1.8 GLX	1800	1985->1987	4	1.8SE SOHC	0,8	BPR6ES	96989		
KADETT	1.8 GSI	1800	1989->1990	4	C18NZ	0,8	BPR7ES	95164		
KADETT	1.8 GSI	1800	1989->1990	4	SE	0,8	BPR6ES	96989		
KADETT	1.8 GTE	1800	1984->1985	4	18LVH SOHC	0,8	BPR6ES	96989		
KADETT	1.8 I S	1800	1988->	4	C118NE	0,8	BKR6EK	94007		
KADETT	2.0 GSI	2000	1989->	4	XE	0,8	BCPR7ES	93606		
KADETT	2.0 GSI	2000	1990->	4	SEH	0,8	BPR6ES	96989		
KADETT	2.0 GSI, 8V	2000	1989->1989	4	SV	0,8	BPR6ES	96989		
KADETT	2.0 I GSI, CD 16V	2000	1991->1992	4	XE	0,8	BCPR7ES	93606		
KADETT	2.0 I S	2000	1993->1998	4	20SEH	0,8	BKR6EK	94007		
KADETT	2.0 I S	2000	1993->1998	4	20SEH SOHC	0,8	BPR6ES	96989		
KADETT	2.0 SUPER BOSS 16V	2000	1989->1990	4	XEH	0,8	BCPR7ES	93606		
KADETT	2.0 TS	2000	1993->1996	4	20LET DOHC	0,8	BCPR6ET	2197		
MERIVA	1.4 I	1400	2006->	4	Z14XEP	1,1	ZFR5F-11	93814		
MERIVA	1.6 I	1600	2003->	4	Z16XE	0,8	BKR6EK	94007		
MERIVA	1.6 I	1600	2006->	4	Z16XEP	1,1	ZFR5F-11	93814		
MERIVA	1.6 I	1600	2006->	4	Z16XEP	0,8	ZFR6BP-G	1748		
MERIVA	1.6 OPC TURBO	1600	2006->2008	4	Z16LET	1	PFR6T-G	6314	BKR6ES-11	94437
MERIVA	1.6 OPC TURBO	1600	2009->	4	A16LET	1	PFR6T-G	6314	BKR6ES-11	94437
MERIVA	1.7 CDTI	1700	2004->2005	4	Z17DTH		Y-541J	4617		
MERIVA	1.7 CDTI	1700	2006->	4	Z17 DTR		Y9004AS	90860		
MERIVA	1.8 I	1800	2003->	4	Z18XE	0,8	BKR5EK	90426		
MERIVA B	1.4 T	1400	2011->	4	A14NET	0,7	IFR7X-7G	91039		
MOKKA	1.4 T	1400	2012->	4	A14NET	0,7	IFR7X-7G	91039		
MONZA	1.6 CLS	1600	1986->1993	4	SV	0,8	BPR6ES	96989		
MONZA	1.6 GSI	1600	1990->1993	4	SE	0,8	BPR6ES	96989		
MONZA	1.8 GL, GLX	1800	1986->1990	4	SE	0,8	BPR6ES	96989		
MONZA	1.8 GLI	1800	1986->1989	4	SV	0,8	BPR6ES	96989		
MONZA	2.0 CD	2000	1990->1992	4	XEH	0,8	BCPR7ES	93606		
MONZA	2.0 CLX	2000	1993->	4	SE	0,8	BPR6ES	96989		
MONZA	2.0 GLE CARB	2000	1992->1993	4	SV	0,8	BPR6ES	96989		
MONZA	2.0 GLI	2000	1989->1993	4	SEH	0,8	BPR6ES	96989		
MONZA	2.0 I CLI	2000	1989->1993	4	SE	0,8	BPR6ES	96989		
OMEGA	2.2 I	2200	2001->	4	Z22XE	0,8	BKR6EK	94007		
OMEGA	2.6 I	2600	2001->	6	Y26SE	0,8	BKR6EQUP	3199	BKR6EQUA	6872
OMEGA	3.2 V6	3200	2001->	6	Y32SE	0,8	BKR6EQUP	3199	BKR6EQUA	6872
REKORD	2.0 BERLINA	2000	1983->1987	4	20NE CIH	0,7	BPR6HS	7022		
REKORD	2.0 GLE, CLS, CLE	2000	1988->1990	4	SEH	0,8	BPR6ES	96989		
REKORD	2.0 GL, GLE	2000	1988->1991	4	20SE CIH	0,8	BPR6ES	96989		
REKORD	2.0 I CLS, CLE	2000	1990->1995	4	SV	0,8	BPR6ES	96989		
REKORD	2.0 L, GL	2000	1982->1988	4	20S	0,6	BP6HS	4511	BPR6HS	7022
REKORD	2.2 E, GLS, BERLINA	2200	1986->1991	4	22NE CIH	0,7	BPR6HS	7022		
REKORD	3.8 I CD, GSI	3800	1991->1995	6	GE	1,3	BPR5EFS-13	2359		
SENATOR	3.0 E	3000	1982->1987	6	30 NE CIH	0,6	BP6HS	4511	BPR6HS	7022
TIGRA B	1.4 I	1400	2005->	4	Z14XEP	1,1	ZFR5F-11	93814		
TIGRA B	1.8 I	1800	2005->	4	Z18XE	1,1	ZFR5F-11	93814		
VECTRA C	1.6 I	1600	2002->	4	Z16XE	0,8	BKR5EQUPA	3566	BKR5EKU	3964
VECTRA C	1.8 I	1800	2002->	4	Z18XE	0,8	BKR5EQUPA	3566	BKR5EKU	3964
VECTRA C	3.2 V6	3200	2002->	6	Z32SE	0,8	BKR5EQUPA	3566	BKR5EKU	3964
VIVARO	1.9 DTI	1900	2001->	4	F9Q		Y-732J	5909		
VIVARO	2.0 I	2000	2002->	4	F4R	1,1	PFR6G-11	5555	BKR6E-11	94306
ZAFIRA	1.6 I	1600	2006->	4	Z16SE	0,8	BKR5EK	90426		
ZAFIRA	1.8 CD	1800	2001->2006	4	Z18XE	0,8	BKR5EK	90426		
ZAFIRA	1.9 CDTI	1900	2006->	4	Z19DTL		Y-534J	5540		

OPEL



CAR • SUV • LCV



Model	Type	Capacity	Year	Cyl	Engine	Gap	Recommended	Stock Code	Alternative	Stock Code
OPEL										
ZAFIRA	2.0 TURBO	2000	2002->	4	Z20LET	0,8	BKR5EK	90426		
ZAFIRA	2.2 I	2200	2004->2006	4	Z22SE	1,3	TR5B-13	97667		
ZAFIRA B	1.6 I	1600	2005->	4	Z16XEP	1,1	ZFR5F-11	93814		
ZAFIRA B	1.6 I	1600	2008->	4	Z16XER	1,1	ZFR5F-11	93814		
ZAFIRA B	1.8 I	1800	2005->	4	Z18XER	1,1	ZFR5F-11	93814		
ZAFIRA B	1.9 CDTI	1900	2005->	4	Z19DTH		YE07	6092		
ZAFIRA B	2.0 OPC	2000	2005->	4	Z20LEH	0,8	PFR6T-G	6314	BKR6ES-11	94437
ZAFIRA B	2.0 TURBO	2000	2005->	4	Z20LER	1,1	ZFR5F-11	93814		
ZAFIRA B	2.2 I	2200	2005->	4	Z22YH	0,8	BKR5EQUPA	3566	BKR5EKU	3964
PEUGEOT										
1007	1.4 16V	1400	2005->	4	ET3J4	0,8	LZKAR7A	6799		
1007	1.4 16V	1400	2005->	4	TU3JP	1,1	BKR6E-11	94306		
1007	1.6 16V	1600	2005->	4	TU5JP4	0,9	LFR6B	6677		
107	1.0 I	1000	2006->	3	1KR-FE	1,1	LFR6C-11	96098	ILFR6T-11	4904
108	1.0 VTI 68	1000	2014->	3	1KR-FE	1	LZKR6AI-10G	97999		
2008	1.6 120 VTI	1600	2013->	4	EP6C	0,8	PLZKBR7B8G			
2008	1.6 E-HDI	1600	2013->	4	DV6TED4		Y8001AS	8851		
2008	THP 110	1199	2017->		EB2DT HNZ	1	LZKR6AI-10G			
206	1.4 SW	1400	2005->	4	ET3J4-KFU	0,8	LZKAR7A	6799		
206	1.4 XR, SW, POPART	1400	2001->2004	4	TU3JP-KFX	0,8	BKR6EZ	4619		
206	1.6 I XT, SW	1600	2001->	4	TU5JP4-NFU	0,9	LFR6B	6677		
206	2.0 GTI, SW	2000	2001->	4	EW10J4-RFR, RFN	0,9	LFR6B	6677		
206	2.0 HDI	2000	2004->2005	4	DW10TD		Y-504J	6246		
206	2.0 I	2000	1999->	4	EW10J4	0,8	LFR5B	7113		
206	2.0 S16	2000	2002->	4	EW10J4S-RFK	0,8	LFR6B	6677		
207	1.4 16V	1400	2006->	4	KFV	0,8	LZKAR7A	6799		
207	1.4 HDI	1400	2006->	4	DV4TD		YE04	1101		
207	1.4 I	1400	2006->	4	TU3A	0,8	BKR6EZ	4619		
207	1.4 VTI 95	1400	2007->	4	EP3 / EP3C	0,8	PLZKBR7B8G			
207	1.6 16V	1600	2006->	4	TU5JP4	0,9	LFR6B	6677		
207	1.6 16V HDI	1600	2006->	4	DV6TED4		YE04	1101		
207	1.6 HDI	1600	2006->	4	DV6		YE05	5207		
207	1.6 RC	1600	2007->	4	EP6DTS	0,8	PLZKBR7B8G			
208	1.0 VTI 68	1000	2012->	3	EBO	1	LZKR6AI-10G	97999		
208	1.2 VTI 82	1200	2012->	3	EB2	1	LZKR6AI-10G	97999		
208	1.4 95 VTI	1400	2012->	4	EP3C	0,8	PLZKBR7B8G			
208	1.6 120 VTI	1600	2012->	4	EP6C	0,8	PLZKBR7B8G			
208	1.6 120 VTI	1600	2012->	4	EP6C	0,8	PLZKBR7B8G			
208	1.6 155 THP	1600	2012->	4	EP6CDT	0,8	PLZKBR7B8G			
208	1.6 GTI	1600	2012->	4	EP6CDTXM	0,8	PLZKBR7B8G			
208	1.6 HDI 115	1600	2012->	4	DV6C		Y8001AS	8851		
208	1.6 HDI 92	1600	2012->	4	DV6TED		Y8001AS	8851		
3008	1.6 155 THP	1600	2009->	4	EP6CDT	0,8	PLZKBR7B8G			
3008	1.6 VTI	1600	2009->	4	EP6	0,8	PLZKBR7B8G			
3008	2.0 16V HDI	2000	2009->	4	DW10CTED4		Y8001AS	8851		
305	1.5 GR FWD	1500	1979->1989	4	XR5	0,8	BP6EFS	93834	BPR6EFS	92170
305	1.5 SR FWD	1500	1979->1989	4	XR5S	0,8	BP6EFS	93834	BPR6EFS	92170
306	1.6 XR, XT	1600	1998->2001	4	TU5.JP	0,8	BKR6EK	94007		
306	1.8 CABRIOLET	1800	1998->2002	4	XU7.JP4	0,8	BCPR6ET	2197		
306	2.0 GTI	2000	1999->2001	4	XU10.J4RS	0,8	BKR5EZ	7642		
306	2.0 XSI	2000	1995->2000	4	XU10.J2	0,8	BCPR6ET	2197		
307	1.4 I	1400	2004->	4	ET3J4 KFU	0,8	LZKAR7A	6799		
307	1.6 HDI	1600	2004->2006	4	DV6TED4		YE04	1101		
307	1.6 XT, XS, CC, SW	1600	2001->	4	TU5JP4-NFU	0,9	LFR6B	6677		
307	2.0 CC, SW	2000	2003->	4	EW10J4-RFN	0,9	LFR5B	7113		
307	2.0 COUPE	2000	2003->	4	EW10J4	0,9	LFR5B	7113		
307	2.0 I	2000	2006->	4	EW10A	0,9	LFR5B	7113		
307	2.0 XS HDI	2000	2001->2005	4	DW10TD		Y-504J	6246		
308	1.2	1200	2015->	3	EB2	1	LZKR6AI-10G	97999		
308	1.6 125THP	1600	2013->	4	EP6CDT	0,8	PLZKBR7B8G			
308	1.6 16V	1600	2007->	4	EP6DT	0,8	PLZKBR7B8G			
308	1.6 T	1600	2013->	4	EP6CDT	0,8	PLZKBR7B8G			
308	2.0 HDI	2000	2007->	4	DW10BTED4		Y-1005J	8939		
308	2.0 HDI	2000	2007->2009	4	DW10BTED		Y-1005J	8939		
308	2.0 HDI 140	2000	2010->	4	DW10BTED		Y-1005J	8939		
4008	2.0 I	2000	2012->	4	4B11	0,8	FR6EI	2687		
404	1.7 LCV	1700		4		0,6	B6L	3212		
404	1.8 GL	1800	1965->	4		0,8	BPR6ES	96989		
405	1.6 GR	1600	1968->1980	4	XU5	0,8	BCPR6ES	96990	BCP6ES	94000
405	1.8 GR	1800	1995->1997	4	XU7JP	0,8	BKR5EK	90426		



CAR • SUV • LCV

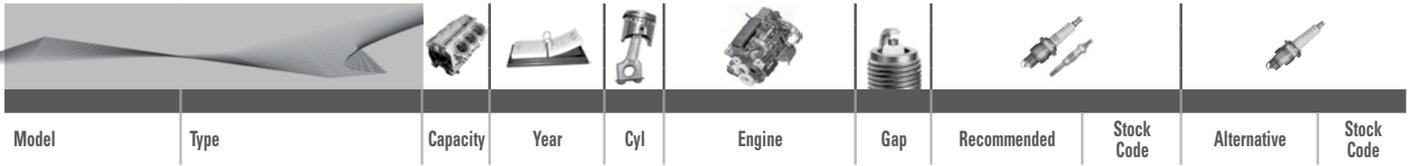

Model	Type	Capacity	Year	Cyl	Engine	Gap	Recommended	Stock Code	Alternative	Stock Code
PEUGEOT										
405	1.9 GR	1900	1987->1995	4	XU92C	0,8	BCPR6ES	96990	BCP6ES	94000
405	2.0 SRI	2000	1995->1997	4	XU10J2	0,8	BKR5EK	90426		
406	1.8 E,16V	1800	2001->	4	EW7J4-6FZ	0,9	LF5B	7113		
406	2.0 COUPE	2000	2001->	4	EW10J4-RFR	0,9	LF5B	7113		
406	2.0 D ST	2000	2002->2004	4	DW10TD/ED		Y-504J	6246		
406	2.0 ST	2000	1996->1997	4	XU10J4R	0,8	BKR5EK	90426		
406	2.2 COUPE	2200	2001->	4	EW12J4-3FZ	0,9	LF5B	7113		
406	2.2 HDI PHASE 2	2200	2000->2003	4	DW12TED4		Y-504J	6246		
406	3.0 SV	3000	2000->	6	ES9J4	0,8	BKR6EK	94007		
406	3.0 V6	3000	2000->2005	6	ES9J4S-XFX	1,1	PLFR5A-11	6240	LF5A-11	95304
407	2.0 HDI	2000	2004->	4	DW10TED		Y-504J	6246		
407	2.0 SW,ST	2000	2004->	4	EW10J4-RFR	0,9	LF5B	7113		
407	2.2 ST	2200	2004->	4	EW12J4-3FZ	0,9	LF5B	7113		
407	3.0 ST	3000	2004->	6	ES9J4S-XFX	1,1	PLFR5A-11	6240	LF5A-11	95304
5008	1.6 THP	1600	2009->	4	EP6CDT	0,8	PLZKBR7B8G			
504	1.8 GR,L	1800	1976->1980	4	XM7	0,8	BPR6ES	96989		
505	2.0 SR	2000	1980->1985	4	XN,XM	0,8	BPR6ES	96989		
505	2.0 STI	2000	1980->1985	4	ZEJ	0,8	BP6EFS	93834	BPR6EFS	92170
505	2.2 GTI	2000	1984->1985	4	ZAJ	0,8	BP6EFS	93834	BPR6EFS	92170
505	2.2 TURBO	2200	1984->1988	4	N9T	0,8	BR7ES	5122		
505	2.5 TD	2500	1986->1993	4	XD 3 TE		Y-924J	3473		
508	1.6 THP	1600	2011->	4	EP6CDT	0,8	PLZKBR7B8G			
508	1.6 VTI	1600	2011->	4	EP6C	0,8	PLZKBR7B8G			
508	2.0 HDI 140	2000	2010->	4	DW10BTE4		Y-1005J	8939		
508	2.0 HDI 165	2000	2010->	4	DW10CTED4		Y8001AS	8851		
605	2.0 SRI	2000	1996->1997	4	XU10.JJZ	0,8	BCPR6ET	2197		
605	3.0 SRI V6	3000	1995->1997	6	ZPJ	0,8	BCPR6ET	2197		
607	2.0 E	2000	2001->	4	EW10J4-RFN	0,9	LF5B	7113		
607	2.2 16V HDI	2200	2000->	4	DW12TED4		Y-504J	6246		
607	2.2 E	2200	2001->	4	EW12J4-3FZ	0,9	LF5B	7113		
607	3.0 V6	3000	2002->	6	ES9J4S	1,1	PLFR5A-11	6240	LF5A-11	95304
806	1.9 D	1900	1994->2001	4	XUD9TF		Y-924J	3473		
806	2.0 16V	2000	2001->	4	EW10J4-RFR	0,9	LF5B	7113		
806	2.0 ST	2000	1998->2000	4	XU10J2	0,8	BKR6EK	94007		
807	2.2 HDI	2200	2002->	4	DW12TED4,4HW		Y-504J	6246		
807	2.2 ST,SV	2200	2003->	4	EW12J4-3FZ	0,9	LF5B	7113		
807	3.0 V6	3000	2002->	6	ES9J4S-XFX	1,1	PLFR5A-11	6240	LF5A-11	95304
BOXER	BOX 3.0 HDI	3000	2006->	4	F1CE		Y-534J	5540		
BOXER 2	2.0 HDI	2000	1998->	4	DW10D		Y-504J	6246		
BOXER 2	2.2 HDI	2200	2001->	4	DW10TED4		Y-504J	6246		
BOXTER	2.2 HDI	2200	2001->2006	4	DW12UTED		Y-1005J	8939		
EXPERT	2.0 D	2000	2000->	4	DW10TED		Y-504J	6246		
EXPERT	2.0 HDI	2000	2000->	4	DW10ATED		Y-504J	6246		
EXPERT	2.0 HDI	2000	2000->	4	DW10TED		Y-504J	6246		
EXPERT	2.0 HDI	2000	2006->	4	DW10BTE4		Y-1005J	8939		
EXPERT	2.0 HDI	2000	2006->	4	DW10UTED4		Y-1005J	8939		
PARTNER	1.6 HDI	1600	2006->	4	DV6		YE05	5207		
PARTNER	1.6 I	1600	2001->	4	TU5JP4-NFU	0,9	LF5B	7113		
PARTNER	1.9 D COMBI	1900	2003->	4	XUD9A		Y-924J	3473		
PARTNER	1.9 D MULTISPACE	1900	1998->	4	DW8 / DW8B		Y-503J	5005		
PARTNER	2.0 HDI MULTISPACE,COMBI	2000	1999->2002	4	DW10TD		Y-504J	6246		
RCZ	1.6 THP	1600	2010->	4	EP6CDT	0,8	PLZKBR7B8G			
RCZ	1.6 THP	1600	2010->	4	EP6CDTX	0,8	ILZKBR7B8G			

PORSCHE										
Model	Type	Capacity	Year	Cyl	Engine	Gap	Recommended	Stock Code	Alternative	Stock Code
911	3.0 SC	3000	1981->1983	6	M9301	0,8	BR8EIX	5044	BR8ES	5422
911	CARREA 997	3600	2004->	6	M9605	0,8	BKR7EQUP	4285	BKR7EQU	5881
911	CARREA 997	3600	2004->	6	M9605	0,8	BKR7EQUP	4285	BKR7EQU	5881
911	CARREA S 997	3800	2004->	6	M9701	0,8	BKR7EQUP	4285	BKR7EQU	5881
911	CARRERA	3200	1985->1989	6	M93020/26	0,8	BR8ES	5422		
911	CARRERA 2 964	3600	1990->1993	6	M6402	0,8	BCPR7ET	2164		
911	CARRERA 4 964	3600	1990->1994	6	M6401	0,8	BCPR7ET	2164		
911	CARRERA 996	3400	1999->2000	6	M9601	0,8	BKR6EQU	3199	BKR6EQU	6872
911	CARRERA S 997	3800	2004->	6	M9701	0,8	BKR7EQUP	4285	BKR7EQU	5881
911	GT3 996	3600	2001->2004	6	M9676	0,8	BKR7EIX	2667	BCPR7ES	93606
911	TURBO 964	3300	1985->1989	6	M3069	0,8	B8ES	2411	BR8ES	5422
911	TURBO 996	3600	2001->2006	6	M9670	0,8	BCPR7ET	2164		
911	TURBO 996	3600	2001->2006	6	M9670	0,8	BCPR7ET	2164		
924	2.0 S	2000	1975->1985	4		0,8	BPR7ES	95164		
924	2.0 TURBO	2000	1980->1983	4	M3103	0,8	BR8EIX	5044	BR8ES	5422
924	924 S	2500	1985->1988	4	M4407/08/09/10	0,8	BPR6EIX	6637		



CAR • SUV • LCV



Model	Type	Capacity	Year	Cyl	Engine	Gap	Recommended	Stock Code	Alternative	Stock Code
PORSCHE										
928	928 GTS	5400	1991->1995	8	M2849	0,8	BP6ET	90921	BP6ES	91076
928	928 S	4500	1985->1992	8	M2821	0,8	BPR6EIX	6637		
944	2.5 TURBO	2500	1985->1991	4	M4450	0,8	BPR6EIX	6637	BP6ES	91076
968	3.0 CS	3000	1991->1995	6	M4443	0,8	BP6ET	90921	BP6ES	91076
BOXSTER	2.7 987	2700	2004->	6	M9625	0,8	BKR7EQUP	4285	BKR7EKU	5881
BOXSTER	2.7 987	2700	2005->	6	M9625	0,8	BKR7EQUP	4285	BKR7EKU	5881
BOXSTER	2.7 TIPTRONIC	2700	2002->	6	M9620	0,8	BKR6EK	94007		
BOXSTER	2.9 987	2900	2008->	6	M9625/20	0,8	BKR7EQUP	4285	BKR7EKU	5881
BOXSTER	3.2 986 S	3200	2002->	6	M9624	0,8	BKR6EQUP	3199	BKR6EQUA	6872
BOXSTER	3.4 987	3400	2006->	6	M9721	0,8	BKR7EQUP	4285	BKR7EKU	5881
BOXSTER	3.4 987	3400	2008->	6	M9726/21	0,8	BKR7EQUP	4285	BKR7EKU	5881
CAYENNE	3.0 D	3000	2011->	6	MCR.CA		Y-10Q2AS	8926		
CAYENNE	3.0 S HYBRID	3000	2012->	6		0,8	PFR7S8EG	1675		
CAYENNE	3.2 955	3200	2004->	6	MO2.2Y BFD	0,8	ILZKR7B	7563	ZKR7A-10	1691
CAYENNE	3.6 I	3600	2010->	6	M55.02	0,8	ILZKR8A	94290		
CAYENNE	3.6 I	3600	2010->	6	M55.02	0,8	ILZKR8A	94290		
CAYENNE	3.6 V6	3600	2010->	6	M55.01	0,8	ILZKR7A	1961	LZKAR7A	6799
CAYENNE	4.1 D	4200	2011->	8	MCU.DB		Y-10Q2AS	8926		
CAYENNE	4.5 S	4500	2005->	8	M48.00	0,8	BKR6EQUP	3199	BKR6EQUA	6872
CAYENNE	4.5 TURBO	4500	2005->	8	M48.50	0,8	PFR7Q	7963	BCPR7ES	93606
CAYENNE	4.8 TURBO	4800	2011->	8		0,8	ILFR7H	5245	LFR7A	92038
CAYMAN	2.7 S	2700	2006->	6	M9720	0,8	BKR7EQUP	4285	BKR7EKU	5881
CAYMAN	3.4 S	3400	2005->	6	M9721	0,8	BKR7EQUP	4285	BKR7EKU	5881

PROTON										
ARENA	1.5 I	1500	2006->	4	4G15	1,1	BPR5ES-11	4424		
GEN 2	1.6 16V	1600	2006->	4	4G92	1,3	BPR6EF-13	2402		
PERSONA	1.6 I	1600	2009->	4	4G92	1,3	BPR6EF-13	2402		
PERSONA	1.8 I	1800	2005->	4	4G92	1,1	BKR6E-11	94306		
PERSONA	2.0 I V6	2000	2005->	6	MDI	1,1	PFR6J-11	2743	BKR6E-11	94306
SAGA	1.3 I	1300	2011->	4	S4PE	0,8	BPR6EFS	92170		
SATRIA	1.3 I	1300	2005->	4	4G13	0,8	BPR5ES	94084		
SATRIA	1.6 I	1600	2005->	4	4G92	1,1	BKR6E-11	94306		
SAVVY	1.2 I	1200	2005->	4	D4F	0,8	LZKAR7A	6799		
WIRA	1.5 I	1500	2005->	4	4G15	1,1	BPR5ES-11	4424		
WIRA	1.6 I	1600	2005->	4	4G92	1,1	BKR6E-11	94306		
WIRA	1.8 I	1800	2005->	4	4G93	1,1	BKR6E-11	94306		

RENAULT										
AVANTIME	2.2 D	2200	2002->2003	4			Y-517J	3319		
CAPTUR	0.9 T	900	2015->	3	H4BT	0,7	ILKAR7F7G	90061		
CAPTUR	1.2 TCE 120	1200	2013->	4	H5F 403	0,7	ILKAR7J7G	91121		
CAPTUR	1.5 DCI	1500	2013->	4	K9K 830 / 838		Y-1035AS	96614		
CLIO	1.2 16V	1200	2004->	4	D4F728,D4F722	0,8	LZKAR7A	6799		
CLIO	1.2 I	1200	2001->	4	D7F 720,722	0,8	BKR5EK	90426		
CLIO	1.4 RT 8V	1400	1999->2001	4	E6J, E7J	0,8	BCPR6ES	96990	BCP6ES	94000
CLIO	1.6 16V	1600	1999->	4	K4M	0,8	BKR6EK	94007		
CLIO	2.0 16V	2000	1998->	4	F7R 700	0,8	BKR6EK	94007		
CLIO	CLIO SPORT V6	2946	2002->2004	6	L7X760	0,9	PFR7Z-TG	5768		
CLIO 2	1.2 16V	1200	2003->	4	D4F-712	0,8	LZKAR7A	6799		
CLIO 2	1.4 RT 16V	1400	2001->	4	K4J-712	0,8	BKR6EK	94007		
CLIO 2	1.5 DCI PHASE 2	1500	2001->	4	K9K-702		Y-732J	5909		
CLIO 2	1.9 D	1900	1999->2003	4	F8Q 632		Y-516J	1436		
CLIO 2	2.0 16V RS SPORT	2000	2000->	4	F4R 730	1	PFR6E-10	3688	BKR6E-11	94306
CLIO 2	3.0 V6	3000	2001->	6	L7X	1	PFR6E-10	3688	BKR6E-11	94306
CLIO 3	1.2 16V	1200	2007->	4	D4F 722,740,772	0,8	LZKAR7A	6799		
CLIO 3	1.2 TCE	1200	2007->	4	D4F 780	0,7	ILKAR7A-7	91432	LKAR7B-11	4801
CLIO 3	1.4 16V	1400	2006->	4	K4J 780	0,8	BKR6EZ	4619		
CLIO 3	1.5 DCI	1500	2006->	4	K9K 764,766,768		Y-732J	5909		
CLIO 3	1.6 16V VVT	1600	2006->	4	K4M 800,801,804	0,8	BKR6EZ	4619		
CLIO 3	2.0 16V RS	2000	2008->	4	F4R830	0,8	PFR7Z-TG	5768		
CLIO 3	2.0 WILLIAMS 16S	2000	1993->1996	4	F7R700	0,8	BKR6EKUB	3584		
CLIO 4	0.9 T	900	2013->	3	HB4T	0,7	ILKAR7F7G	90061		
CLIO 4	1.2 I	1200	2012->	4	D4F 740	0,7	ILKAR7A-7	91432	LKAR7B-11	4801
CLIO 4	1.5 DCI 75	1500	2012->	4	K9K 612		Y-1035AS	96614		
CLIO 4	1.5 DCI 90	1500	2012->	4	K9K 608		Y-1035AS	96614		
CLIO 4	1.6 RS CUP	1600	2013->	4	M5M 400	0,9	DILKAR7C-9H	91215		
DUSTER	1.5 DCI	1500	2012->	4	K9K		Y-1035AS	96614		
DUSTER	1.6 16V	1600	2011->	4	K4M	0,8	BKR6EZ	4619		
ESPACE	2.0 DCI	2000	2007->2015	4	M9R740		CZ167	91063		



CAR • SUV • LCV



Model	Type	Capacity	Year	Cyl	Engine	Gap	Recommended	Stock Code	Alternative	Stock Code
RENAULT										
ESPACE	2.0 DCI	2000	2007->2015	4	M9R750		CZ167	91063		
ESPACE	2.0 MPV	2000	1996->1997	4	J7R	0,8	BP6EFS	93834	BPR6EFS	92170
ESPACE	2.8 MPV	2800	1996->2003	6	Z7W-712	0,8	BP7EFS	3526		
ESPACE	3.0 I	3000	1998->	6	L7X	1	PFR6E-10	3688	BKR6E-11	94306
ESPACE 4	2.0 16V	2000	2003->	4	F4R	1,1	PFR6G-11	5555	BKR6E-11	94306
ESPACE 4	2.2 DCI	2200	2005->	4	G9T		Y-517J	3319		
ESPACE 4	3.5 V6	3500	2003->	6	V4Y-711	1,1	PLFR5A-11	6240	LF5A-11	95304
FLUENCE	1.5 DCI	1500	2010->	4	K9K 830/832/834/836		Y-1035AS	96614		
FLUENCE	1.6 16V	1600	2008->	4	H4M (HR16DE)	1,1	PLZKAR6A-11	5118	LZKAR6C-11	96343
FLUENCE	1.6 16V	1600	2010->	4	K4M 838/839	0,8	BKR6EZ	4619		
FLUENCE	1.6 I	1600	2013->	4	K4M 838/839	0,8	BKR6EZ	4619		
FLUENCE	2.0 16V	2000	2010->	4	M4R 714 /751	1,1	PLZKAR6A-11	5118	LZKAR6C-11	96343
FLUENCE	2.0 I	1600	2013->	4	M4R 714/751	1,1	PLZKAR6A-11	5118	LZKAR6C-11	96343
FUEGO	1.6 TURBO	1600	1983->1986	4	A5L	0,8	B8ES	2411	BR8ES	5422
FUEGO	2.1 TDI	2100	1982->1984	4	J8S		Y-924J	3473		
GRAND ESPACE	1.9 DCI	1900	2002->	4	F9Q		Y-732J	5909		
GRAND ESPACE	2.2 DCI	2200	2003->	4	G9T		Y-517J	3319		
GRAND ESPACE	3.0 RXT	3000	2001->	6	Z7X	0,8	BCPR6ET	2197		
GRAND SCENIC	1.5 DCI	1500	2004->	4	K9K		Y-732J	5909		
GRAND SCENIC	1.6 16V	1600	2004->	4	K4M	0,8	BKR6EZ	4619		
GRAND SCENIC	1.6 DCI	1600	2011->	4	R9M 402		Y1010AS	97618		
GRAND SCENIC	1.9 DCI	1900	2004->	4	F9Q		Y-732J	5909		
GRAND SCENIC	2.0 16V	2000	2004->	4	F4R	0,8	BKR6EZ	4619		
GRAND SCENIC	2.0 16V	2000	2004->	4	F4RT	1,1	PFR6G-11	5555	BKR6E-11	94306
GRAND SCENIC	2.0 DCI	2000	2007->2008	4	M9R		CZ167	91063		
KADJAR	1.2 T	1200	2015->	4	H5F408	0,7	ILKAR7F7G	90061		
KADJAR	1.5 DCI	1500	2015->	4	K9K		Y-1035AS	96614		
KADJAR	1.6 DCI	1600	2015->	4	R9M 410/414/412		Y1010AS	97618		
KANGOO	1.4 I	1400	2000->	4	K7J	0,8	BKR5EZ	7642		
KANGOO 2	1.6 I	1600	2003->	4	K4M	0,8	BKR6EZ	4619		
KANGOO EXPRESS	1.4 EXPRESS	1400	2001->	4	EJ7	0,8	BCP5ES	7496		
KANGOO EXPRESS	1.5 DCI EXPRESS	1500	2004->	4	K9K		Y-732J	5909		
KANGOO EXPRESS	1.9 DCI	1900	2004->	4	F9Q		Y-732J	5909		
KOLEOS	2.0 DCI	2000	2008->	4	M9R855		CZ167	91063		
KOLEOS	2.5 I	2500	2008->	4	2TR700,702,703	1,1	DILKAR6A-11	9029	PLZKAR6A-11	5118
KWID	1.0 I	1000	2016->	3		0,8	LZKAR7A	6799		
LAGUNA	1.8 RN, RT, ESTATE	1800	1996->1998	4	F3P	0,8	BPR6ES	96989		
LAGUNA	2.0 DCI	2000	2007->2015	4	M9R74S		CZ167	91063		
LAGUNA	2.0 RT, RXE, ESTATE	2000	1996->1998	4	F3R	0,8	BPR6ES	96989		
LAGUNA	2.0 RXT	2000	1997->2001	4	N7Q	0,8	BKR6EK	94007		
LAGUNA	3.0 RXT 24V	3000	1998->2001	6	L7X 700,701	1	PFR6E-10	3688	BKR6E-11	94306
LAGUNA	3.0 V6	3000	1996->1998	6	Z7X	0,8	BKR6EK	94007		
LAGUNA 2	1.8 I	1800	2002->2005	4	F4P-760	0,8	BKR6E	97737		
LAGUNA 2	1.9 EX	1900	2003->2005	4	F9Q C750		Y-732J	5909		
LAGUNA 2	2.0 I	2000	2002->2005	4	F3R	0,8	BKR6EK	94007		
LAGUNA 2	2.0 TURBO	2000	2003->	4	F4RT	1,1	PFR6G-11	5555	BKR6E-11	94306
LAGUNA 2	3.0 V6	3000	2001->2005	6	L7X-731	1,1	PLFR5A-11	6240	LF5A-11	95304
LAGUNA 3	1.6 16V	1600	2007->	4	K4M	0,8	BKR6EZ	4619		
LAGUNA 3	2.0 16V	2000	2007->	4	F4R	0,8	BKR6EZ	4619		
LAGUNA 3	2.0 TURBO	2000	2007->	4	F4R762	1,1	PFR6G-11	5555	BKR6E-11	94306
LAGUNA 3	2.0 TURBO	2000	2007->	4	F4R830	0,8	PFR7Z-TG	5768		
LOGAN	1.6 I	1600	2005->	4	K7M	0,8	BKR6EK	94007		
MEGANE	1.4 RTE	1400	1999->2003	4	E7J,K4J	0,8	BKR6E	97737		
MEGANE	1.4 TCE	1400	2008->	4	H4JT.700	0,7	ILKAR7A-7	91432	LKAR7B-11	4801
MEGANE	1.4 TCE 130	1400	2009->	4	H4J 700	0,7	ILKAR7A-7	91432	LKAR7B-11	4801
MEGANE	1.5 DCI	1500	2003->2007	4	K9K		Y-732J	5909		
MEGANE	1.5 DCI	1500	2008->	4	K9K		Y-1035AS	96614		
MEGANE	1.6 16V	1600	2008->	4	K4M 858	0,8	BKR6EZ	4619		
MEGANE	1.6 DCI	1600	2011->	4			Y1010AS	97618		
MEGANE	1.6 L	1600	2003->	4	K4M760	0,8	BKR6E	97737		
MEGANE	1.6 RN, RT, COUPE	1600	1997->1999	4	K7M	0,8	BKR6E	97737		
MEGANE	1.8 I	1800	2001->	4	F4P	1,1	BKR6E-11	94306		
MÉGANE	1.9 DCI	1900	2003->	4	F9Q800		Y-732J	5909		
MEGANE	1.9 DCI	1900	2008->	4	F9Q870/874		Y-1036AS	96062		
MÉGANE	1.9 DTI PHASE 2	1900	2001->	4	F9QT770		Y-732J	5909		
MEGANE	2.0 16V	2000	2003->	4	F4R	0,8	BKR6E	97737		
MEGANE	2.0 16V	2000	2005->	4	F4R 760	1,1	PFR6G-11	5555	BKR6E-11	94306
MEGANE	2.0 COUPE	2000	1997->1998	4	F7R	0,8	BKR6EK	94007		
MEGANE	2.0 DCI	2000	2007->2008	4	M9R722		CZ167	91063		
MEGANE	2.0 GT	2000	2013->	4	F4R 874	1,1	PFR6N-11	3546	BKR6E-11	94306
MEGANE	2.0 RS	2000	2006->	4	F4R 830	0,8	PFR7Z-TG	5768		
MEGANE	2.0 RS TURBO	2000	2005->	4	F4RT.774	1,1	PFR7G-11	2380	BCPR7ES	93606

RENAULT



CAR • SUV • LCV



Model	Type	Capacity	Year	Cyl	Engine	Gap	Recommended	Stock Code	Alternative	Stock Code
RENAULT										
MEGANE	2.0 RS TURBO	2000	2007->	4	F4RT.774	0,8	PFR7Z-TG	5768		
MEGANE	2.0 RXE	2000	1997->1999	4	F3R	0,8	BKR6E	97737		
MEGANE	RS SPORT 265	2000	2013->	4	F4R 874	1,1	PFR6N-11	3546	BKR6E-11	94306
MEGANE COUPE	1.2 L	1197	2014->	4	H5F404	0,7	ILKAR7F7G	90061		
MEGANE COUPE	2.0 I	2000	1999->	4	H5F	0,9	LF85B	7113		
MODUS	1.2 16V	1200	2005->	4	D4F	0,8	LZKAR7A	6799		
MODUS	1.4 16V	1400	2005->	4	K4J	0,8	BKR6EZ	4619		
MODUS	1.5 DCI	1500	2005->	4	K9K		Y-732J	5909		
MODUS	1.6 16V	1600	2005->	4	K4M	0,8	BKR6EZ	4619		
R11	1.4 TS	1400	1985->1986	4	C1J 715/ C2 J73	0,8	BPR6ES	96989		
R11	1.7 TX,TXE	1700	1985->1986	4	F2N/ F3N-708	0,8	BPR6ES	96989		
R5	1.3 VAN	1300	1980->1985	4		0,6	BP6HS	4511	BPR6HS	7022
R5	1.3 GTL	1300	1977->1985	4		0,8	BPR5ES	94084		
R5	1.3 TS,LS	1300	1975->1982	4		0,6	BP6HS	4511	BPR6HS	7022
R9	1.4 TSE,TL,GTI	1400	1983->1986	4		0,8	BPR6ES	96989		
R9	1.7 TXE	1700	1984->1986	4	F2N/ F3N-708	0,8	BPR7ES	95164		
SAFRANE	2.1 DT RN,RT	2100	1992->1996	4	J8S760		Y-924J	3473		
SAFRANE	2.2 PHASE 2 DT RTE,RXE,RXT	2200	1996->2000	4	G8T740		Y-730U	2273		
SAFRANE	2.5 DT RN,RT,RXE	2500	1993->1996	4	S8U762/763		Y-924J	3473		
SAFRANE	2.5 I	2500	1995->	5	N7Q	0,8	BCPR6ES	96990	BCP6ES	94000
SANDERO	0.9 T	1000	2013->	3	H4B 400	0,7	ILKAR7J7G	91121		
SANDERO	1.2 16V	1200	2013->	4	D4F 734/732	0,8	LZKAR7A	6799		
SANDERO	1.4 I	1400	2010->	4	K7J 710	0,8	BKR6E	97737		
SANDERO	1.5 DCI	1500	2010->	4	K9K 796		Y-732J	5909		
SANDERO	1.5 DCI 75	1500	2013->	4	K9K 838		Y-1035AS	96614		
SANDERO	1.5 DCI 90	1500	2013->	4	K9K 612		Y-1035AS	96614		
SANDERO	1.6 16V	1600	2008->	4	K4M 858	0,8	BKR6EZ	4619		
SANDERO	1.6 MPI	1600	2010->	4	K4M 710	0,8	BKR6EK	94007		
SCENIC	1.5 DCI	1500	2004->	4	K9K		Y-732J	5909		
SCENIC	1.6 I	1600	1998->1999	4	K4M 702 703 720	0,8	BKR5EZ	7642		
SCENIC	1.9 DCI	1900	2003->2004	4	F9Q 718,731,736		Y-732J	5909		
SCENIC	1.9 DCI	1900	2005->2008	4	F9Q 804		Y-732J	5909		
SCENIC	2.0 DCI	2000	2007->2008	4	M9R		CZ167	91063		
SCENIC	2.0 RXI	2000	1998->2000	4	N7Q	0,8	BKR6EK	94007		
SCENIC 2	1.4 RTE	1400	2001->2004	4	K4J	0,8	BKR6EK	94007		
SCENIC 2	1.6 I	1600	1998->	4	K4M	0,8	BKR6EZ	4619		
SCENIC 2	2.0 NR4	2000	2000->	4	F4R 740,744	0,8	BKR6E	97737		
SCENIC 3	1.4 TCE	1400	2009->	4	H4J	0,7	ILKAR7A-7	91432	LKAR7B-11	4801
SCENIC 3	1.6 DCI	1600	2012->	4			Y1010AS	97618		
SCENIC 3	2.0 16V	2000	2009->	4	M4R 710	1,1	PLZKAR6A-11	5118	LZKAR6C-11	96343
TRAFIC	1.9 DCI	1900	2005->	4	F9Q762		Y-732J	5909		
TWINGO	0.9 TCE 90	900	2014->	3	H4B 401	0,7	ILKAR7J7G	91121		
TWINGO	1.2 I	1200	2007->	4	D4F-722,740,764	0,8	LZKAR7A	6799		
TWINGO 2	1.5 DCI 75	1500	2010->	4	K9K 820		Y-1035AS	96614		
TWINGO 2	1.5 DCI 90	1500	2010->	4	K9K 820		Y-1035AS	96614		
TWINGO 2	1.6 I	1600	2008->	4	K4M 854	0,8	PFR7Z-TG	5768		

ROLLS ROYCE										
PHANTOM	6.7 FV12	6700	2003->2005	12		0,8	BKR6EQUP	3199	BKR6EQUA	6872

ROVER										
75	1.8 TURBO	1800	2004->	4	K SERIES	1,1	PFR6N-11	3546	BKR6E-11	94306
75	2.5 CLUB,CONN.,TOURER	2500	2003->	6	KV6	1,1	PFR6N-11	3546	BKR6E-11	94306
MAESTRO	2.0 TD	2000	1989->	4	PERKINS-PRIMA 80 T		Y-924J	3473		
MAESTRO	500, 700 D	2200	1986->1989	4			Y-924J	3473		
ROVER	2.6 SD	2600	1978->1984	6	R6	0,8	BPR6ES	96989		
ROVER	3.5 SDS,SDE V8	3500	1978->1984	8		0,8	BPR5ES	94084		

SAAB										
3-SEP	1.8 TURBO	1800	2002->	4	B207L	1	PFR6T-G	6314	BKR6ES-11	94437
3-SEP	1.9 DTH	1900	2005->	4	Z19DTH		YE07	6092		
3-SEP	2.0 BI TURBO	2000	2007->	4	Z20NFL	0,8	BCPR7ES	93606		
3-SEP	2.0 T	2000	1998->	4	B204L	0,8	BCPR7ES	93606		
3-SEP	2.3 I	2300	1997->2002	4	B235R	1,1	PFR6G-11	5555	BKR6E-11	94306
3-SEP	2.8 V6	2800	2001->2012	6	B284 E / L	1	DILFR6J-11	92491	PLFER7A8EG	94833
5-SEP	2.0 I	2000	2007->	4	A20NHL	0,8	BCPR7ES	93606		
5-SEP	2.3 AERO TURBO	2300	1998->2006	4	B205L	1,1	PFR6G-11	5555	BKR6E-11	94306
5-SEP	2.3 SE,TURBO	2300	1998->2006	4	B235E	0,8	BCPR7ES	93606		
5-SEP	3.0 GRIFFIN V6	3000	1998->2006	6	B308E	0,8	BCPR7ES	93606		



CAR • SUV • LCV



Model	Type	Capacity	Year	Cyl	Engine	Gap	Recommended	Stock Code	Alternative	Stock Code
SAAB										
900	2.0 SE	2000	1994->1998	4	B202	0,8	BCPR7ES	93606		
900	2.0 SE TURBO	2000	1994->	4	B202L	0,8	BCP7EVX	7681	BCP7ES	5030
9000	2.3 CD, CS, CDE, CSE	2300	1990->	4	B234	0,8	BCPR7ES	93606		
9000	3.0 V6	3000	1990->	6	B308	0,8	BKR5EK	90426		

SEAT										
ALTEA	1.6 FI	1600	2006->	4	BGU,BSE	1	BKUR6ET-10	90599		
ALTEA	1.8 TFSI	1800	2009->	4	CDAA	0,8	PFR7S8EG	1675		
ALTEA	1.9 TDI	1900	2006->	4	BXE		Y-607AS	9776		
ALTEA	2.0 FSI	2000	2004->2005	4	BLR	1,1	PZFR5N-11T	7742		
ALTEA	2.0 FSI	2000	2004->2005	4	BLY	0,8	BKR6E	97737		
ALTEA	2.0 TDI	2000	2004->	4	BKD		YE14	5661		
ALTEA	2.0 TDI	2000	2006->	4	BMM		Y-607AS	9776		
ALTEA	2.0 TFSI	2000	2006->	4	BWA	0,8	PFR7S8EG	1675		
IBIZA	1.4 FSI	1400	2009->	4	CAVF	0,8	PZFR6R	5758	ZFR6F-11	93208
IBIZA	1.4 I	1400	2006->	4	BXW	1,1	ZFR6T-11G	96211		
IBIZA	1.4 I	1600	2006->	4	BXW	1,1	ZFR6T-11G	96211		
IBIZA	1.4 TFSI	1400	2009->	4	CAVE	0,8	PZFR6R	5758	ZFR6F-11	93208
IBIZA	1.4 I	1400	2008->	4	CGGB	1,1	ZFR6T-11G	96211		
IBIZA	1.6 FI	1600	2007->	4	BAH	1,1	PZFR5D-11	7968	ZFR5F-11	93814
IBIZA	1.6 I	1600	2006->	4	BTS	1,1	ZFR6T-11G	96211		
IBIZA	1.8 CUPRA	1800	2006->	4	BBU,BLZ	0,8	PFR6Q	6458	BKR6E	97737
IBIZA	1.9 TDI CUPRA	1900	2006->	4	BPX		Y-741U	5065		
IBIZA	2.0 I	2000	2004->	4	BBX	1	BKUR6ET-10	90599		
LEÓN	1.6 I	1600	2004->	4	AEH, AKL	1	BKUR6ET-10	90599		
LEÓN	1.6 I	1600	2009->	4	CCSA	1	BKUR6ET-10	90599		
LEÓN	1.8 20V	1800	2004->	4	ARY	0,8	PFR6Q	6458	BKR6E	97737
LEÓN	1.8 TFSI	1800	2009->	4	CDAA	0,8	PFR7S8EG	1675		
LEÓN	2.0 FSI	2000	2005->	4	BLR,BVZ,BVY	1,1	PZFR5N-11T	7742		
LEÓN	2.0 FSI	2000	2006->2009	4	BWJ	0,8	PFR7S8EG	1675		
LEÓN	2.0 TDI	2000	2005->	4	BKD		YE14	5661		
LEÓN	2.0 TDI	2000	2005->2007	4	BMM		Y-607AS	9776		
LEÓN	2.0 TFSI	2000	2005->2006	4	BWA	0,8	PFR7S8EG	1675		
LEÓN	2.3 16V	2300	2003->	5	AON	1,1	PZFR5D-11	7968	ZFR5F-11	93814
LEÓN	2.8 FSI	2800	2004->	6	BDE	1,1	PZFR5D-11	7968	ZFR5F-11	93814
TALEDO	1.6 L	1600	1991->1999	4	ABN	0,8	BP7ET	3684	BP7ES	95442

SMART										
1000	1.0 FOR TWO	1000	2008->	3	M132.930	0,9	LKR7B-9	5847		
600	0.6 I	600	1998->2003	3	M160	0,8	BKR6EKE	5649		
700	0.7 I	700	2002->2005	3	M160.01	0,7	LKR8A	5214		
700	0.7 ROADSTER	700	2003->2005	3	M160.01	0,7	LKR8A	5214		
FORFOUR	1.4 I	1300	2004->2006	4	M135.930	1,1	LFR6C-11	96098	ILFR6T-11	4904
FORFOUR	1.5 I	1500	2004->2006	4	M135.950	1,1	LFR6C-11	96098	ILFR6T-11	4904
FORTWO	0.7 I	700	2004->	3	M160.01	0,7	LKR8A	5214		
FORTWO	1.0 T	1000	2012->	3	M132.930	0,9	LKR7B-9	5847		
FORTWO	1.0	1000	2007->	3	M132.910	0,9	LKR7B-9	5847		

SSANGYONG										
ACTYON	2.0 XDI	2000	2006->	4			Y-536J	91617		
ACTYON	2.7 XDI	2700	2007->	5			Y-536J	91617		
KORANDO	2.0 I	2000	1996->	4	M111.940	0,8	BCP5ES	7496		
KORANDO	K230 EL	2300	1997->	4	E23	1,1	BKR5E-11	93674		
KORANDO	K290 EL	2900	2000->	4			Y-916J	4454		
KORANDO	K320 EL	3200	1997->	6		1,1	BKR5E-11	93674		
KORANDO	K601,K602 EL	2900	1997->1999	6	M602		Y-916J	4454		
KYRON	2.0 XDI	2000	2006->	4			Y-536J	91617		
KYRON	2.7 XDI	2700	2007->	5			Y-536J	91617		
MUSSO	2.9 S TD SPORTS	2900	2005->	5			Y-916J	4454		
MUSSO	602 D	2900	1993->2000	5	MB-OM 602		Y-916J	4454		
MUSSO	E 230	2300	1997->	4	M111	0,8	BKR5E	90841		
MUSSO	E 320	3200	1997->	6	M104	0,8	BKR5E	90841		
REXTON	RX 230	2300	2002->	4	G23D	0,8	BCPR6ES	96990	BCP6ES	94000
REXTON	RX 270 XDI	2700	2005->2006	5	D27DT		Y-536J	91617		
REXTON	RX 270 XDI	2700	2006->	5	D27DT		Y-537AS	9994		
REXTON	RX 290 S	2900	1999->	5			Y-916J	4454		
REXTON	RX 320 I	3200	2002->	6	G32D	0,8	BCPR6ES	96990	BCP6ES	94000
RODIUS	2.7 D	2700	2005->	5	CRD		Y-745U	4705		

SAAB



CAR • SUV • LCV

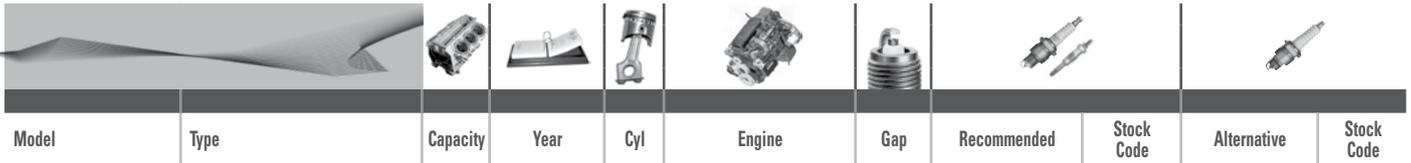

Model	Type	Capacity	Year	Cyl	Engine	Gap	Recommended	Stock Code	Alternative	Stock Code
-------	------	----------	------	-----	--------	-----	-------------	------------	-------------	------------

SSANGYONG

STAVIC	270 SVD	2900	2005->	5			Y-745U	4705		
STAVIC	320 SV	3200	2006->	6		0,8	BCPR6ES	96990	BCP6ES	94000

SUBARU

BRZ	2.0	2000	2012->	4	FA20D		R7437-9	4654	R7438-9	4656
FORESTER	2.0 D	2000	2012->	4	EE20		Y-606J	92828		
FORESTER	2.0 GL	2000	2005->	4	EJ20	0,8	ILFR6B	6481	LFR6B	6677
FORESTER	2.0 GL,GX,GT	2000	1998->	4	EJ20	0,8	BKR6E	97737		
FORESTER	2.0 GT	2000	2008->	4	EJ20	0,8	ILFR6B	6481	LFR6B	6677
FORESTER	2.0 X	2000	2008->	4	EJ204	1,1	SILFR6A-11	5468	LFR6A-11	3672
FORESTER	2.0 XT	2000	2013->	4	FA20E/F	0,6	ILKAR8H-6	96024		
FORESTER	2.5 I	2500	2005->	4	EJ25	1,1	PFR6G-11	5555	BKR6E-11	94306
FORESTER	2.5 I	2500	2006->2008	4	EJ25	0,8	ILFR6B	6481	LFR6B	6677
FORESTER	2.5 I	2500	2008->	4	EJ25	0,8	ILFR6B	6481	LFR6B	6677
FORESTER	2.5 I	2500	2011->	5	FB25	1,1	SILZKAR7B11	93482		
FORESTER	2.5 X	2500	2013->	4	FB25A	1,1	SILZKAR7B11	93482		
FORESTER	2.5 XS	2500	2009->	4	EJ253	1,1	PFR6B-11	4014		
FORESTER	FORESTER X	2457	2002->2005	4	EJ251	0,7	PFR6B	3500	BKR6E	97737
IMPREZA	1.5 R	1500	2007->	4	EJ15	0,8	ILFR6B	6481	LFR6B	6677
IMPREZA	1.8 GL/GT	1800	1994->1996	4	EJ18	0,8	BKR6E	97737		
IMPREZA	2.0 I	2000	2010->	4	EJ204	1,1	SILFR6C11	7505		
IMPREZA	2.0 R	2000	2006->	4	EJ20	0,8	ILFR6B	6481	LFR6B	6677
IMPREZA	2.0 R	2000	2007->	4	EK20	0,8	ILFR6B	6481	LFR6B	6677
IMPREZA	2.0 RS	2000	2004->	4	EJ20	1,1	BKR6E-11	94306		
IMPREZA	2.0 WRX STI	2000	2004->	4	EJ20	1,1	PFR6G-11	5555	BKR6E-11	94306
IMPREZA	2.0 WRX TURBO	2000	1995->	4	EJ20	0,8	PFR6B	3500	BKR6E	97737
IMPREZA	2.5 WRX STI	2500	2005->2007	4	EJ25	0,8	ILFR6B	6481	LFR6B	6677
IMPREZA	2.5 WRX STI	2500	2008->	4	EJ25	1,1	SILFR6A-11	5468	LFR6A-11	3672
LEGACY	2.0 GL	2000	1996->	4	EJ20	1,1	BKR6E-11	94306		
LEGACY	2.0 L	2000	2004->	4	EJ20	1,1	BKR6E-11	94306		
LEGACY	2.2 GX 4X4	2200	1994->1999	4	EJ22	1,1	BKR6E-11	94306		
LEGACY	2.5	2457	2006->2011	4	EJ25DET	1,1	PFR5B11		BKR5E-11	93674
LEGACY	2.5 GL	2500	1998->2003	4	EJ25	1,1	BKR6E-11	94306		
LEGACY	2.5 GX	2500	1998->	4	EJ25	1,1	BKR6E-11	94306		
LEGACY	3.0 R	3000	2005->	6	EZ30	0,8	ILFR6B	6481	LFR6B	6677
OUTBACK	2.5 I	2500	2003->2008	4	EJ25	1,1	PFR6B-11	4014	BKR6E-11	94306
OUTBACK	2.5 I	2500	2006->	4	H4 EJ255	1,1	PFR6B-11	4014	BKR6E-11	94306
OUTBACK	2.5 I	2500	2009->	4	EJ253	1,1	SIFR6A-11	127		
OUTBACK	3.0 I	3000	2006->	6	H6 EZ30D	1,1	SILFR6C11	7505		
OUTBACK	3.6 R	3600	2009->	6	EZ36D	1,1	SILFR6C11	7505		
SPORTS COUPE	3.3 SVX 4X4	3300	1994->	6	EG33	1,1	BKR6ES-11	94437		
TRAVIQ	2.2 16V	2200	2001->2005	4		1	LTR6B-10T	5948		
TRIBECA	3.0 B9	3000	2006->	6	EZ30	0,8	ILFR6B	6481	LFR6B	6677
TRIBECA	3.6 L 24V	3600	2007->	6	EJ36	1,1	SILFR6A-11	5468	LFR6A-11	3672
XV	2.0 I	2000	2012->	4	FB20A/ FB20B	1,1	SILZKAR7B11	93482		
XV	2.0 R	2000	2011->	4	FB20A	1,1	SILZKAR7B11	93482		

SUZUKI

ALTO	1.0 GL	1000	2009->	4	G10B	1,1	BKR6E-11	94306		
ALTO	1.0 GL, GLS	1000	2009->	4	K10B	1	KR6A-10	1678		
ALTO	1.0 I	1000	2009->	3	K10B	1,1	IKR6G-11	7980		
ALTO	1.6 I	1600	2015->	4		0,9	LKR6E-9N	90151	LKR6D-10E	96569
BALENO	1.4 BALENO	1372	2016->	4	K14B	1	KR6A-10	1678		
CELERIO	1.0 GL	1000	2015->	3	K10	1	KR6A-10	1678		
CIAZ	1.4 I	1400	2015->	4	K14B	1	KR6A-10	1678		
CIAZ	1.4 I	1400	2015->	4	K14B	1	LKR6F-10	93728	LKR6D-10E	96569
DZIRE	1.2	1200	2018->	4	K12M	1	LKR6F-10	93728	LKR6D-10E	96569
ERTIGA	1.4 I	1400	2012->	4	K14B	1	KR6A-10	1678		
GRAND VITARA	1.6 16V MULTI-POINT INJECT	1600	1999->	4	G16B	0,8	BKR6E	97737		
GRAND VITARA	1.6 I VVT	1600	2005->	4	M16A	1,1	IFR6J-11	7658	BKR6E-11	94306
GRAND VITARA	2.0 I	2000	1998->2000	4	J20A	1,1	BKR6E-11	94306		
GRAND VITARA	2.0 JB420	2000	2005->	4	J20A	1,1	IFR6J-11	7658	BKR6E-11	94306
GRAND VITARA	2.4 I	2400	2008->	4	J24B	1,1	SILFR6A-11	5468	LFR6A-11	3672
GRAND VITARA	2.4 VVT	2400	2008->	4	J24B	1,1	SILFR6A-11	5468	LFR6A-11	3672
GRAND VITARA	2.5 I	2500	1999->	6	H25	1,1	BKR6E-11	94306		
GRAND VITARA	2.7 I	2700	2003->	6	H27	1,1	IFR6J-11	7658	BKR6E-11	94306
GRAND VITARA	3.2 I V6	3200	2010->	6		1,3	PTR5A-13	2467	TR5B-13	97667
JIMNY	1.3 VVT	1300	2000->	4	M13A	1,1	IFR6J-11	7658	BKR6E-11	94306
JIMNY	1.5 DDIS	1500	2003->	4	K9K		Y-732J	5909		
KIZASHI	2.4 I	2400	2010->	4	J24B	1,1	SILFR6A-11	5468	LFR6A-11	3672



CAR • SUV • LCV

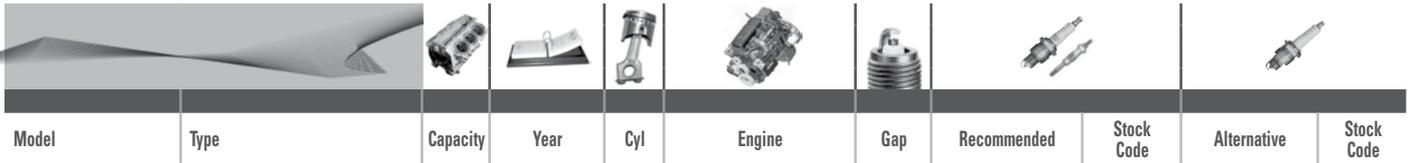

Model	Type	Capacity	Year	Cyl	Engine	Gap	Recommended	Stock Code	Alternative	Stock Code
SUZUKI										
SAMURAI	1.3 I	1300	1992->	4	G13A	0,8	BPR5ES	94084		
SAMURAI	1.9 TD	1900	1998->	4			Y-924J	3473		
SJ 410	1.0 4 X4	1000	1983->1989	3		0,8	BPR5ES	94084		
SJ 413	1.3 4 X4	1300	1986->1989	4		0,8	BPR6ES	96989		
SPLASH	1.2 VVT	1200	2012->	4	K12B	1,1	IKR6G-11	7980		
ST 90	1.0 MICROBUS	1000	1983->1989	4	F8A	0,8	BPR5ES	94084		
SWIFT	1.2 DZIRE	1200	2014->	4	K12C	1	LKR6F-10	93728	LKR6D-10E	96569
SWIFT	1.2 I	1200	2010->	4	K12B	1,1	IKR6G-11	7980		
SWIFT	1.3 I	1300	2005->	4	M13A	1,1	IFR6J-11	7658	BKR6E-11	94306
SWIFT	1.4 I	1400	2010->	4	K14B	0,8	KR6A-10	1678		
SWIFT	1.5 GL, GLS VVT	1500	2005->	4	M15A	1,1	IFR6J-11	7658	BKR6E-11	94306
SWIFT	1.6 I	1600	2005->	4	M16A	1,1	IFR6J-11	7658	BKR6E-11	94306
SWIFT	1.6 I	1600	2012->	4	M16A	1,1	SILFR6A-11	5468	IFR6A-11	3672
SWIFT	1.6 I VVT	1600	2007->2011	4	M16A	1,1	IFR6J-11	7658	BKR6E-11	94306
SX4	1.5 I	1500	2006->	4	M15A	1,1	IFR6J-11	7658	BKR6E-11	94306
SX4	1.6 VVT	1600	2006->2012	4	M16A	1,1	IFR6J-11	7658	BKR6E-11	94306
SX4	1.6 VVT	1600	2013->	4	M16A	1,1	SILFR6A-11	5468	IFR6A-11	3672
SX4	1.9 TD	1900	2006->	4	D19AA		Y-534J	5540		
SX4	2.0 CVT	2000	2010->	4	J20B	1,1	SILFR6A-11	5468	IFR6A-11	3672
SX4	2.0 MT VVT	2000	2006->	4	J20A	1,1	IFR6J-11	7658	BKR6E-11	94306
VITARA	1.6 16V	1600	1995->1998	4	G16A	0,8	BKR6E	97737		
VITARA	2.0 24V V6	2000	1999->	6	H20A DOHC	0,8	BKR6E	97737		

TATA										
475	1.4 TCIS	1400	2014->	4			Y-503J	5005		
BOLT	1.2 T	1200	2015->	4		1	LKR6D-10E	96569		
INDICA	1.4 DLS, DLX	1400	2005->	4			Y-503J	5005		
INDICA	1.4 I	1400	2004->	4		0,8	BCPR6ES	96990	BCP6ES	94000
INDICA	1.4 I	1400	2009->	4	350A.1000	1	ZKR7A-10	1691		
INDIGO	1.4 I	1400	2004->	4		0,8	BCPR6ES	96990	BCP6ES	94000
TELCOLINE	2.0 TD	2000	2004->	4			Y-918J	3704		
VISTA	1.4 I	1400	2009->	4	350A.1000	1	ZKR7A-10	1691		
VISTA	1.4 I	1400	2011->	4	350A.1000	1	ZKR7A-10	1691		
XENON	3.0 DICOR	3000	2007->	4			Y-8005J	94629		

TOYOTA										
1200	1.2 PICK-UP	1200	1986->	4	3K	0,8	BPR6ES	96989		
86	COUPE 2.0 ZN6	2000	2012->	4	FA20D		R7437-9	4654	R7438-9	4656
AURIS	1.3 VVT	1300	2008->	4	1NR-FE	1,1	ILKAR7B-11	4912	LKAR7B-11	4801
AURIS	1.4 VVT	1400	2007->2007	4	4ZZ-FE	1,1	BKR5EYA-11	93627		
AURIS	1.6 VVT	1600	2007->2008	4	1ZR-FE	1,1	ILKAR7B-11	4912	LKAR7B-11	4801
AURIS	1.6 VVT	1600	2008->	4	1ZR-FAE	1,1	ILKAR7B-11	4912	LKAR7B-11	4801
AURIS	1.8 HYBRID	1800	2012->	4	2ZR-FXE	1,1	ILKAR7B-11	4912	LKAR7B-11	4801
AURIS	1.8 VVT	1800	2007->	4	2ZR-FE	1,1	ILKAR7B-11	4912	LKAR7B-11	4801
AURIS	1.8 VVT	1800	2009->	4	2ZR-FAE	1,1	ILKAR7B-11	4912	LKAR7B-11	4801
AURIS	2.0 XD	2000	2012->	4	1CD-FTV		Y-531J	2979		
AVANTE	1.6 GLE	1600	1985->1988	4	4A1	0,8	BPR5ES	94084		
AVANTE	1.6 GLI	1600	1985->1988	4	4AGE	1,1	BCPR6EY-11	91999		
AVANZA	1.3 I	1300	2006->	4	K3VE	0,9	IKR7D	4759	DCPR7EA-9	6651
AVANZA	1.5 I	1500	1999->2005	4	K6VE	0,9	IKR7D	4759	DCPR7EA-9	6651
AVANZA	1.5 VVT	1500	2006->	4	3S2-VE	0,9	IKR7D	4759	DCPR7EA-9	6651
AVANZA	1.6 VVT	1600	2008->	4	1ZR-FAE	1,1	ILKAR7B-11	4912	LKAR7B-11	4801
AVANZA	1.8 VVT	1800	2009->	4	2ZR-FAE	1,1	ILKAR7B-11	4912	LKAR7B-11	4801
AVENSIS	2.0 I	2000	2003->	4	1AZ-FSE	1,1	HB6BIX-11P	5705		
AVENSIS	2.0 I WITH CAT	2000	2006->	4	1AZ-FE	1,1	IFR6T-11	4589	BKR6EYA-11	91206
AVENSIS	2.0 I WITHOUT CAT	2000	2003->	4	1AZ-FE	1,1	BKR6EYA-11	91206		
AVENSIS	2.2 D	2200	2009->	4	2ADFHV		Y-1012J	97930		
AVENSIS	2.4 I	2400	2004->	4	2AZ-FE	1,1	BKR6EYA-11	91206		
AVENSIS	2.4 I	2400	2005->	4	2AZ-FSE	1,1	HB6BIX-11P	5705		
AVENSIS 2	1.6 I	1600	2003->2009	4	3ZZ-FE	1,1	BKR5EYA-11	93627		
AVENSIS 2	1.8 I	1800	2003->2009	4	1ZZ-FE	1,1	BKR5EYA-11	93627		
AVENSIS 2	2.0 I	2000	2003->2009	4	1AZ-FE	1,1	IFR6T-11	4589	BKR6EYA-11	91206
AVENSIS 2	2.0 I	2000	2003->2012	4	1AZ-FSE	1,1	HB6AIX-11P	5703		
AVENSIS 3	1.6 I	1600	2008->	4	1ZR-FAE	1,1	ILKAR7B-11	4912	LKAR7B-11	4801
AVENSIS 3	1.8 I	1800	2008->	4	2ZR-FAE	1,1	ILKAR7B-11	4912	LKAR7B-11	4801
AVENSIS 3	2.0 I	2000	2008->	4	3ZR-FAE	1,1	ILKAR7B-11	4912	LKAR7B-11	4801
AYGO	1.0 I	1000	2011->2013	3	1KR-FE	1,1	ILFR6C-11	96098	ILFR6T-11	4904
AYGO	1.0 I	1000	2014->	3	1KR-FE	1,1	ILKAR7B-11	4912	LKAR7B-11	4801
CAMRY	2.0 I	2000	2003->	4	1AZ-FE	1,1	IFR6T-11	4589	BKR6EYA-11	91206
CAMRY	2.0 I, SI	2000	1992->2001	4	3S-FE	1,1	BKR6EKB-11	3583		

SUZUKI



CAR • SUV • LCV



Model	Type	Capacity	Year	Cyl	Engine	Gap	Recommended	Stock Code	Alternative	Stock Code
TOYOTA										
CAMRY	2.2 SI,SEI	2200	1992->1997	4	5S-FE	1,1	BKR6EYA-11	91206		
CAMRY	2.2 SI,SEI	2200	1997->2002	4	5S-FE	1,1	BKR6EKB-11	3583		
CAMRY	2.4 I	2400	2003->2007	4	2AZ-FE	1,1	BKR6EYA-11	91206		
CAMRY	3.0 I	3000	2003->	6	1MZ-FE	1,1	IFR6T-11	4589	BKR6EYA-11	91206
CAMRY	3.0 SEI	3000	1992->2001	6	3VZ-FE	1,1	BKR6EKB-11	3583		
CAMRY	3.5 XLE	3500	2009->	6	2GR-FE	1,1	DILFR6D-11	6176	LF6D	4704
CARINA	1.5 G	1500	1983->1988	4	5K-J	1,1	BRE529Y-11	6429		
CELICA	2.0 TURBO	2000	->1989	4	3S-GTE	0,8	BKR6EIX	6418		
CELICA	2.0 TURBO	2000	1990->	4	3S-GTE	0,8	BKR6EIX	6418		
CELICA	2.8 SUPRA	2800	1984->1988	6	5MGE	0,8	BPR5EY	94270		
CONDOR	1.8 L	1800	2000->2003	4	2Y	0,8	BPR5EY	94270		
CONDOR	2.0 I	2000	2003->	4	1RZ	0,8	BPR5EY	94270		
CONDOR	2.4 I	2400	2000->	4	2RZ	0,8	BPR5EY	94270		
CONQUEST	1.3 GS,S 12V	1300	1986->1993	4	2EL	0,8	BPR6EY	90310		
CONQUEST	1.3 SPORT	1300	1993->1996	4	2E	1,1	BPR5EY-11	95989		
CONQUEST	1.3 TAZZ	1300	2000->	4	2E	1,1	BPR5EY-11	95989		
CONQUEST	1.6 16V SPORT	1600	1988->1993	4	4AF	0,8	BCRE527Y	94546		
CONQUEST	1.6 GL	1600	1985->1988	4	4AL	0,8	BPR5ES	94084		
CONQUEST	1.6 I RS,SPORT	1600	1993->1998	4	4A-FE	1,1	BKR5EYA-11	93627		
CONQUEST	1.6 RS	1600	1992->	4	4AL	0,8	BPR5ES	94084		
CONQUEST	1.6 RSI	1600	1986->1988	4	4AGE	1,1	BCPR6EY-11	91999		
CONQUEST	1.6 RSI TWINCAM	1600	1988->1993	4	4AGE	0,8	BKR6EYA	91281		
CONQUEST	1.8 I SPORT,RSI	1800	1993->1996	4	7A-FE	0,8	BKR6EYA	91281		
COROLLA	160I GL, GLE	1600	1996->2007	4	4A-FE	1,1	BKR5EYA-11	93627		
COROLLA	1.3 12V	1300	1993->1996	4	2E	1,1	BPR6EY	90310		
COROLLA	1.3 G	1300	1984->1988	4	2AL	0,8	BPR5ES	94084		
COROLLA	1.3 I	1300	2008->	4	1NR-FE	1,1	ILKAR7B-11	4912	LKAR7B-11	4801
COROLLA	1.3 L	1300	1981->1983	4	4K-U	1,1	BRE529Y-11	6429		
COROLLA	1.3 L	1300	1981->1987	4	4K-J	1,1	BRE529Y-11	6429		
COROLLA	1.3 L,GL 12V	1300	->1986	4	2EL	0,8	BPR6EY	90310		
COROLLA	1.3 L,LS,GL RWD	1300	1982->1985	4	4K	0,8	BPR5ES	94084		
COROLLA	1.4 D4D	1400	2004->	4	1ND-TV		Y-542J	5665		
COROLLA	1.4 I	1400	2002->2007	4	4ZZ-FE	1,1	BKR5EYA-11	93627		
COROLLA	1.5 I	1500	1998->2007	4	5A-FE	1,1	BKR5EYA-11	93627		
COROLLA	1.6 16V	1600	1997->2007	4	4A-FE	1,1	BKR5EYA-11	93627		
COROLLA	1.6 16V SPORT	1600	1988->1993	4	4AF	0,8	BCRE527Y	94546		
COROLLA	1.6 GLI T-CAM	1600	1990->	4	4AGE	0,8	BKR6EYA	91281		
COROLLA	1.6 GLI T-CAM	1600	1988->1993	4	4AGE	1,1	BCPR6EY-11	91999		
COROLLA	1.6 GLX,GLS	1600	1988->1993	4	4AF	0,8	BCRE527Y	94546		
COROLLA	1.6 GL, TRD	1600	1980->1985	4	2T	0,8	BPR6ES	96989		
COROLLA	1.6 I	1600	2002->	4	3ZZ-FE	1,1	BKR5EYA-11	93627		
COROLLA	1.6 I	1600	2007->	4	1ZR-FE	1,1	ILKAR7B-11	4912	LKAR7B-11	4801
COROLLA	1.6 I GL,GLE	1600	1993->1996	4	4A-FE	1,1	BKR5EYA-11	93627		
COROLLA	1.6 L	1600	1984->1988	4	4A,4AL	0,8	BPR5ES	94084		
COROLLA	1.6 RSI,RXI 20V	1600	1997->	4	4AGE	1,1	BKR6EP-11	2978	BKR6E-11	94306
COROLLA	1.6 SE	1600	1980->1983	4	2TB	0,8	BPR5ES	94084		
COROLLA	1.6 T-CAM	1600	1985->1988	4	4AGE	0,8	BCPR6EY	94699		
COROLLA	1.6 VAN	1600	1983->1989	4	2T	0,8	BPR5ES	94084		
COROLLA	1.8 I	1800	2002->	4	2ZZ-GE	1,1	IFR6T-11	4589	BKR6EYA-11	91206
COROLLA	1.8 I GSX	1800	2002->	4	1ZZ-FE	1,1	BKR5EYA-11	93627		
COROLLA	1.8 I GSX,GLE,SPORT	1800	1993->1996	4	7A-FE	0,8	BKR6EYA	91281		
COROLLA	1.8 L	1800	2007->	4	2ZR-FE	1,1	ILKAR7B-11	4912	LKAR7B-11	4801
COROLLA	1.8 SE,GLS SPRINTER	1800	1980->1985	4	3T	0,8	BPR5ES	94084		
COROLLA	1.8 TRD	1800	1980->1981	4	3T	0,8	BPR6ES	96989		
COROLLA	1.8 VERSO	1800	2004->2007	4	1ZZ-FE	1,1	BKR5EYA-11	93627		
COROLLA	2.0 D4D	2000	2007->	4	1AD-FTV		Y-1012J	97930		
COROLLA	2.0 VERSO	2000	2001->2007	4	1ZZ-FE	1,1	BKR5EYA-11	93627		
COROLLA	2.0 VVT	2000	2010->	4	3ZR-FAE	1,1	ILKAR7B-11	4912	LKAR7B-11	4801
COROLLA	2.2 D VERSO D-CAT	2200	2005->2009	4	2AD-FHV		Y-1012J	97930		
COROLLA	2.4 XRS	2400	2009->	4	2AZ-FE	1,1	IFR6T-11	4589	BKR6EYA-11	91206
COROLLA QUEST	1.6 I	1600	2014->	4	1ZR-FE	1,1	ILKAR7B-11	4912	LKAR7B-11	4801
COROLLA QUEST	1.8	1800	2020->	4	2ZR-FE	1,1	ILKAR7B-11	4912	LKAR7B-11	4801
COROLLA VERSO	1.6 I	1600	2005->	4	3ZZ-FE	1,1	BKR5EYA-11	93627		
COROLLA VERSO	1.8 I	1800	2005->	4	1ZZ-FE	1,1	BKR5EYA-11	93627		
COROLLA VERSO	2.0 I	2000	2001->	4	1ZZ-FE	1,1	BKR5EYA-11	93627		
CORONA	1.5 GL	1500	1983->1987	4	5K-J	1,1	BRE529Y-11	6429		
CRESSIDA	1.8 L	1800	1976->1981	4	18R	0,8	BPR6ES	96989		
CRESSIDA	1.8 LS	1800	1986->1989	4	2Y	0,8	BPR5ES	94084		
CRESSIDA	1.8 L,LS,DX	1800	1980->1986	4	3T	0,8	BPR5ES	94084		
CRESSIDA	2.0 GLE	2000	1983->1986	4	21R	0,8	BPR6ES	96989		
CRESSIDA	2.0 GLI 6	2000	1983->1986	6	1GE	0,8	BPR6ES	96989		
CRESSIDA	2.0 GLI 6	2000	1986->1989	6	1GE	0,8	BPR6ES	96989		



CAR • SUV • LCV

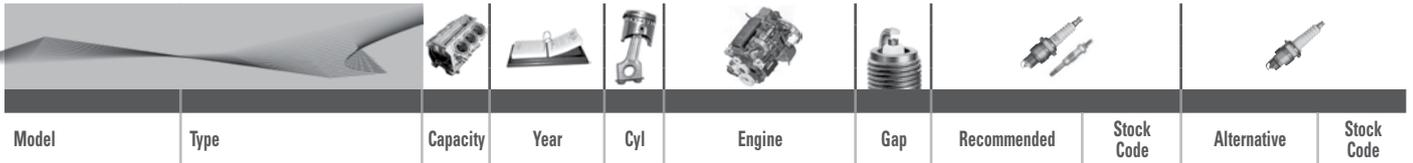

Model	Type	Capacity	Year	Cyl	Engine	Gap	Recommended	Stock Code	Alternative	Stock Code
TOYOTA										
CRESSIDA	2.0 GLI 6	2000	1989->1992	6	1GFE	0,8	BKR6EYA	91281		
CRESSIDA	2.0 GL, GLX	2000	1981->1986	4	21R	0,8	BPR6ES	96989		
CRESSIDA	2.0 GS	2000	1989->1992	4	3Y	0,8	BPR5ES	94084		
CRESSIDA	2.4 GL, GLE	2400	1987->1992	4	22R	0,8	BPR6ES	96989		
CRESSIDA	2.8 I	2800	1985->1986	6	5ME	0,8	BPR5EY	94270		
CRESSIDA	2.8 RSI	2800	1986->1989	6	5MGE	0,8	BPR5EY	94270		
CRESSIDA	3.0 GLS 24V	3000	1989->	6	7MGE	0,8	BCPR6EY	94699		
CRESSIDA	3.0 TURBO	3000	1989->1992	6	7MGE	0,8	BCPR7ES	93606		
DYNA	2.0 L	2000	1978->1986	4	5R	0,8	BPR6ES	96989		
DYNA	2.0 L	2000	1985->1995	4	3Y	0,8	BPR5ES	94084		
DYNA	2.0 LWB	2000	1985->1995	4	5Y	0,8	BPR6ES	96989		
DYNA	2.2 6-094	2200	1994->1996	4	4Y	0,8	BPR6ES	96989		
ETIOS	1.5 I	1500	2012->	4	2NR	1,1	LFRC-11	93998		
FJ CRUISER	4.0 I	4000	2011->	6	1GR-FE	1,1	LFRC-11	96098	ILFR6T-11	4904
FORTUNER	2.5 D4D	2500	2007->	4	2KD-FTV		Y-531J	2979		
FORTUNER	2.7	2694	2016->	4	2TR-FE	1,1	LFRC-11	96098	ILFR6T-11	4904
FORTUNER	3.0 D	3000	2006->	4	1KD-FTV		Y-531J	2979		
FORTUNER	3.0 D4D	3000	2002->2006	4	1KD-FTV		Y-531J	2979		
FORTUNER	4.0 I	4000	2006->	6	1GR-FE	1,1	LFRC-11	96098	ILFR6T-11	4904
HARRIER	3.0 I	3000	1997->2006	6	1MZ-FE	1,1	IFR6T-11	4589	BKR6EYA-11	91206
HI-ACE	1.6 BUS	1600	1979->1987	4	12R	0,8	BPR5ES	94084		
HI-ACE	1.8 WAGON, VAN	1800	1984->1985	4	2Y	0,8	BP5EY	96534	BPR5EY	94270
HI-ACE	2.0 L	2000	1977->1984	4	18R	0,8	BPR5ES	94084		
HI-ACE	2.0 VAN, BUS	2000	1984->1987	4	3Y	0,8	BPR5ES	94084		
HI-ACE	2.2 BUS	2200	1992->	4	4Y	0,8	BP5EY	96534	BPR5EY	94270
HI-ACE	2.2 TURBO ALPINE	2200	1987->	4	4Y	0,5	B6ES	7310		
HI-ACE	2.2 WAGON GLX	2200	1987->2000	4	4Y	0,8	BP5EY	96534	BPR5EY	94270
HI-ACE	2.4 D	2400	1983->1992	4	2L		Y-118-R	2187		
HI-ACE	2.4 D 12V	2400	1983->1992	4	2L		Y-118T-1	2951		
HI-ACE	2.4 D 12V	2400	1993->	4	2L		Y-715R	5376		
HI-LUX	1.6 LWB, SWB	1600	1979->1987	4	1Y	0,8	BPR5ES	94084		
HI-LUX	1.6 SWB	1600	1979->1987	4	12R	0,8	BPR5ES	94084		
HI-LUX	1.8 S, SR	1800	1987->1996	4	2Y	0,8	BPR5ES	94084		
HI-LUX	280 D	2800	1995->1996	4	3L		Y-715R	5376		
HI-LUX	2.0 4X4	2000	1979->1987	4	18R	0,8	BPR5ES	94084		
HI-LUX	2.0 L	2000	2001->	4	1RZ	0,8	BPR5EY	94270		
HI-LUX	2.0 L	2000	2005->	4	1TR-FE	1,1	LFRC-11	96098	ILFR6T-11	4904
HI-LUX	2.0 S	2000	1983->1986	4	3Y	0,8	BPR5ES	94084		
HI-LUX	2.0 VVTI	2000	2005->	4	1TR-FE	1,1	LFRC-11	96098	ILFR6T-11	4904
HI-LUX	2.2 4X4	2200	1985->1986	4	4Y	0,8	BPR5EY	94270		
HI-LUX	2.2 D	2200	1979->	4	L		Y-118T-1	2951		
HI-LUX	2.2 D	2200	1990->	4	2C		Y-146R	7492		
HI-LUX	2.2 D	2400	1983->1992	4	2L		Y-118-R	2187		
HI-LUX	2.2 D SUPER GLOW	2200	1979->	4	L		Y-118-R	2187		
HI-LUX	2.4 D 12V	2400	->1992	4	2L		Y-118-R	2187		
HI-LUX	2.4 S	2400	1994->1996	4	22R	0,8	BPR6ES	96989		
HI-LUX	2.5 D4D	2500	2005->	4	2KD-FTV		Y-531J	2979		
HI-LUX	2.7 VVTI	2700	2005->	4	2TR-FE	1,1	LFRC-11	96098	ILFR6T-11	4904
HI-LUX	2.7I RAIDER, SRX	2700	1998->	4	3RZ-FE	0,8	BKR5EYA	95225		
HI-LUX	3.0 D	3000	2005->	4	5L		Y-715R	5376		
HI-LUX	3.0 D4D	3000	2005->	4	1KD-FTV		Y-531J	2979		
HI-LUX	4.0 I	4000	2005->	6	1GR-FE	1,1	LFRC-11	96098	ILFR6T-11	4904
INNOVA	2.7 VVTI	2700	2011->	4	2TR-FE	1,1	LFRC-11	96098	ILFR6T-11	4904
LAND-CRUISER	2.7 I	2700	2003->	4	3RZ-FE	1,1	BKR5EYA-11	93627		
LAND-CRUISER	2.7 I	2700	2005->	4	2TR-FE	1,1	LFRC-11	96098	ILFR6T-11	4904
LAND-CRUISER	3.0 D	3000	1974->1975	6	B		Y-128	6426		
LAND-CRUISER	3.0 D4D	3000	2003->	4	1KD-FTV		Y-531J	2979		
LAND-CRUISER	3.4 V6 PRADO GX, VX	3400	1997->1999	6	5VZ-FE	1,1	BKR5EKB-11	3967		
LAND-CRUISER	4.0 D	4000	1974->1982	6	H, 2H		Y-147T	7493		
LAND-CRUISER	4.0 D	4000	1981->1985	6	2H		Y-147T	7493		
LAND-CRUISER	4.0 I	4000	1988->	6	3F	0,8	BPR5EY	94270		
LAND-CRUISER	4.0 L	4000	1988->	6	3F	0,8	BP4ES	6928	BPR4ES	7222
LAND-CRUISER	4.0 PRADO	4000	2003->2006	6	1GR-FE	1,1	LFRC-11	96098	ILFR6T-11	4904
LAND-CRUISER	4.2 D	4200	1998->	6	1HD-T		Y-532J	7782		
LAND-CRUISER	4.2 D HZJ 75, 80	4200	1992->1998	6	1HZ		Y-744M	7008		
LAND-CRUISER	4.2 I	4200	1981->1985	6	2F	0,8	BPR5ES	94084		
LAND-CRUISER	4.5 D4D 200 SERIES	4500	2012->	8	1VD-FTV		Y-1012J	97930		
LAND-CRUISER	4.5 D4D 79 SERIES	4500	2012->	8	1VD-FTV		Y-1012J	97930		
LAND-CRUISER	4.5 I	4500	1998->2000	6	1FZ-FE	0,8	BKR5EYA	95225		
LAND-CRUISER	4.5 I	4500	2002->	6	1FZ-FE	1,1	BKR5EKB-11	3967		
LAND-CRUISER	4.6 I	4600	2009->	8	1UR-FE	1,1	LFRC-11	96098	ILFR6A-11	3672

TOYOTA



CAR • SUV • LCV



Model	Type	Capacity	Year	Cyl	Engine	Gap	Recommended	Stock Code	Alternative	Stock Code
TOYOTA										
LAND-CRUISER	4.7 I	4700	2000->	8	2UZ-FE	1,1	IFR6T-11	4589	BKR6EYA-11	91206
LAND-CRUISER	5.7 I	5700	2009->	8	3UR-FE	1,1	LF6C-11	96098	ILFR6T-11	4904
LANDCRUISER	4.0 V6	3956	2007->	6	1GR-FE	1,1	LF6C11			
MR2	1.6 COUPE	1600	1986->1988	4	4AGE	1,1	BCPR6EY-11	91999		
MR2	1.8 SPYDER	1800	2000->	4	1ZZ-FE	1,1	BKR5EYA-11	93627		
MR2	2.0 16V	2000	1993->	4	3SGTE	1,1	BKR6EP-11	2978	BKR6E-11	94306
MR2	2.0 16V	2000	2005->	4	3SGE	1,1	BKR6EP-11	2978	BKR6E-11	94306
MR2	2.2 I	2200	1993->	4	3S-FE	1,1	BKR6EYA-11	91206		
PRADO	3.0 D4D	3000	2010->	4	1KD-FTV		Y-531J	2979		
PRADO	3.0 TX	3000	2010->	4	1KD-FTV		Y-531J	2979		
PRADO	3.4 GX, VX	3400	1997->	6	5VZ-FE	1,1	BKR5EKB-11	3967		
PRADO	4.0 I	4000	2003->	6	1GR-FE	1,1	LF6C-11	96098	ILFR6T-11	4904
PREVIA	2.4 I	2400	1995->1999	4	2TZ-FE	0,8	BKR5EYA	95225		
PRIUS	1.5 HYBRID	1500	2005->2009	4	1NZ-FXE	1,1	IFR5T-11	4996	BKR5E-11	93674
PRIUS	1.8 HYBRID	1800	2009->	4	2ZR-FXE	1,1	ILKAR7B-11	4912	LKAR7B-11	4801
QUANTUM	2.5 D	2500	2005->	4	2KD-FTV		Y-531J	2979		
QUANTUM	2.7 I	2700	2006->	4	2TR-FE	1,1	LF6C-11	96098	ILFR6T-11	4904
RAV 4	1.8 4X2	1800	2003->2006	4	1ZZ-FE	1,1	BKR5EYA-11	93627		
RAV 4	2.0 D4D	2000	2007->	4	1AD-FTV		Y-1012J	97930		
RAV 4	2.0 I	2000	1995->2000	4	3S-FE	1,1	BKR6EYA-11	91206		
RAV 4	2.0 I	2000	2000->2006	4	1AZ-FE	1,1	IFR6T-11	4589	BKR6EYA-11	91206
RAV 4	2.0 I	2000	2008->	4	3ZR-FAE	1,1	ILKAR7B-11	4912	LKAR7B-11	4801
RAV 4	2.2 D	2200	2011->	4	2AD-FTV		Y-1012J	97930		
RAV 4	2.4 I	2400	2005->2007	4	2AZ-FE	1,1	IFR6T-11	4589	BKR6EYA-11	91206
RAV 4	2.5 I	2500	2014->	4	2AR-FE	1,1	LF6C-11	96098	ILFR6T-11	4904
RAV 4	3.5 I	3500	2007->2010	6	2GR-FE	1,1	DILFR6D-11	6176	LF6D	4704
RUN X	1.4 VVT	1400	2003->	4	4ZZ-FE	1,1	BKR5EYA-11	93627		
RUN X	1.6 VVT	1600	2003->	4	3ZZ-FE	1,1	BKR5EYA-11	93627		
RUN X	1.8 RSI	1800	2003->	4	2ZZ-GE	1,1	IFR6T-11	4589	BKR6EYA-11	91206
RUN X	1.8 RX	1800	2004->	4	1ZZ-FE	1,1	BKR5EYA-11	93627		
SEQUOIA	4.7 I	4700	2009->	8	2UZ-FE	1,1	IFR6T-11	4589	BKR6EYA-11	91206
SEQUOIA	5.7 SR5	5700	2009->	8	3UR-FE	1,1	LF6C-11	96098	ILFR6T-11	4904
SESIKILE	2.7 I	2700	2007->	4	2TR-FE	1,1	LF6C-11	96098	ILFR6T-11	4904
STALLION	1.5 L	1500	1987->1992	4	5K	0,8	BPR6ES	96989		
STALLION	1.8 L	1800	1992->1997	4	2Y	0,8	BPR5EY	94270		
STALLION	2.0 I	2000	2003->	4	1RZ	0,8	BPR6ES	96989		
STALLION	2.4 D	2000	1996->	4			Y-118T-1	2951		
STOUT	2.0 CARB	2000	1966->1989	4	3Y	0,8	BPR5ES	94084		
STOUT	2.0 HE	2000	1967->1970	4	5R	0,8	BPR6ES	96989		
SUPRA	3.0 I	3000	1990->1992	6	7MGE	0,8	BCPR6EY	94699		
SUPRA	3.0 V6 BITURBO	3000	1993->1994	6	2JZ-GTE	1,1	BKR6EP-11	2978	BKR6E-11	94306
TUNDRA	4.0 I	4000	2006->	6	1GR-FEFI	1,1	LF6C-11	96098	ILFR6T-11	4904
TUNDRA	4.7 I	4700	2006->	8	2UZ-FEFI	1,1	IFR6T-11	4589	BKR6EYA-11	91206
TUNDRA	5.7 SR5	5700	2009->	8	3UR5BE	1,1	LF6C-11	96098	ILFR6T-11	4904
TUV	1.3 H	1300	1982->1987	4	4K	0,8	BPR5ES	94084		
TUV	1.5 L	1500	1985->1987	4	5K	0,8	BPR6ES	96989		
VENTURE	1.8 L	1800	1992->2000	4	2Y	0,8	BP5EY	96534	BPR5EY	94270
VENTURE	2.2 G	2200	1994->2000	4	4Y	0,8	BPR5ES	94084		
VENTURE	2.4 D	2400	1995->2000	4	2L		Y-118-R	2187		
VERSO	1.6 I	1600	2005->	4	3ZZ-FE	1,1	BKR5EYA-11	93627		
VERSO	1.6 S	1600	2009->	4	1ZR-FAE	1,1	ILKAR7B-11	4912	LKAR7B-11	4801
VERSO	1.8 SX	1800	2009->	4	2ZR-FAE	1,1	ILKAR7B-11	4912	LKAR7B-11	4801
YARIS	1.0 I	1000	2001->	4	1SZ-FE	1,1	BKR6EYA-11	91206		
YARIS	1.0 I	1000	2006->	3	1KR-FE	1,1	LF6C-11	96098	ILFR6T-11	4904
YARIS	1.0 I	1000	2013->	3	1KR-FE	0,8	ILFR6T-11	4904	LF6C-11	96098
YARIS	1.3 VVT	1300	2006->	4	2NZ-FE	1,1	BKR5EYA-11	93627		
YARIS	1.3 VVTI	1300	2011->	4	1NR-FE	1,1	ILKAR7B-11	4912	LKAR7B-11	4801
YARIS	1.5 VVT	1500	2006->2007	4	1NZ-FE	1,1	BKR5EYA-11	93627		
YARIS	1.5 VVT	1500	2010->	4	1NZ-FE	1,1	IFR5T-11	4996	BKR5E-11	93674
YARIS	1.8 TURBO	1800	2008->	4	2ZR-FE	1,1	ILKAR7B-11	4912	LKAR7B-11	4801
TVR										
T350	3.6 I	3600	2003->	6		0,8	BPR6ES	96989		
TAMORA	3.6 I	3600	2003->	6	IL6	0,8	DCPR8E	4339		
TUSCAN	3.5 I	3500	2003->	6		0,8	BPR5ES	94084		
TUSCAN	4.0 I	4000	2003->	6		0,8	DCPR8E	4339		



CAR • SUV • LCV



Model	Type	Capacity	Year	Cyl	Engine	Gap	Recommended	Stock Code	Alternative	Stock Code
VOLKSWAGEN										
AMAROK	2.0 BITDI	2000	2011->	4	CSHA		Y-1002AS	8926	VOLKSWAGEN	
AMAROK	2.0 TD	2000	2011->	4	CDCA		Y-1002AS	8926		
AMAROK	2.0 TDI	2000	2010->	4	CDBA		Y-1002AS	8926		
AMAROK	2.0 TSI	2000	2010->	4	CFPA	0,8	PFR7S8EG	1675		
BEETLE	1.3 L	1300	1966->1979	4	AB,AR,F	0,6	BP6HS	4511	BPR6HS	7022
BEETLE	1.5 GL	1500	1967->1970	4	H	0,6	BP6HS	4511	BPR6HS	7022
BEETLE	1.6 G	1600	1969->1979	4	AS,AD	0,6	BP6HS	4511	BPR6HS	7022
BEETLE	1.8 TURBO	1800	2003->	4	AGU	0,8	PFR6Q	6458	BKR6E	97737
BEETLE	2.0 FI	2000	2007->	4	CBPA	1	BKUR6ET-10	90599		
BEETLE	2.0 I	2000	2003->	4	BER	1,1	PZFR5D-11	7968	ZFR5F-11	93814
BEETLE	2.0 I	2000	2004->	4	BEV	1,1	PZFR5D-11	7968	ZFR5F-11	93814
BEETLE	2.0 I	2000	2005->	4	BHP	1	BKUR6ET-10	90599		
BEETLE	2.0 I HIGHLINE	2000	2000->	4	AQY	1	BKUR6ET-10	90599		
BEETLE 2	1.2 TSI	1200	2011->	4	CBZB	0,7	IZFR6P-7	97153		
BEETLE 2	1.4 TSI	1400	2012->	4	CAVD	0,8	PZFR6R8EG	96498		
BEETLE 2	2.0 TSI	2000	2011->	4	CBFA	0,8	PFR7S8EG	1675		
BEETLE 2	2.0 TSI	2000	2011->	4	CCTA	0,8	PFR7S8EG	1675		
CADDY	1.0 TSI	999	2018->	3	CHZG	0,8	PZKER7B8EGS			
CADDY	1.4 I	1400	2000->	4	AUD	1,1	PZFR5D-11	7968	ZFR5F-11	93814
CADDY	1.4 TGI	1400	2015->	4	CPWA	0,8	PZKER7B8EGS			
CADDY	1.6 I	1600	1983->1991	4	HN,EW	0,8	BPR6ES	96989		
CADDY	1.6 TDI	1600	2011->	4	CLC		Y-1002AS	8926		
CADDY	1.7 TD	1700	1996->2000	4	AHB		Y-918J	3704		
CADDY	1.8 L	1800	1985->	4	JH	0,8	BUR6ET	3172		
CADDY	1.9 SDI	1900	2000->2003	4	AYQ		Y-732J	5909		
CADDY	1.9 TDI	1900	2004->2010	4	BJB		Y-607AS	9776		
CADDY	1.9 TDI	1900	2006->	4	BLS,BSU		Y-607AS	9776		
CADDY	2.0 I	2000	2006->	4	BSX	0,8	BKR6E	97737		
CADDY	2.0 SDI	2000	2004->2010	4	BDJ		Y-741U	5065		
CADDY	2.0 SDI	2000	2004->2010	4	BST		Y-741U	5065		
CADDY	2.0 TDI	2000	2007->	4	BMM		Y-607AS	9776		
CADDY	2.0 TDI	2000	2010->	4	CFHC		Y-1002AS	8926		
CADDY	2.0 TDI	2000	2010->	4	CFHF		Y-1002AS	8926		
CADDY KOMBI	1.6 I	1600	2004->	4	BGU,BSF	1	BKUR6ET-10	90599		
CADDY KOMBI	1.6 I	1600	2015->	4	CWV	1	ZKER6A-10EG	96596		
CALIFORNIA	2.0 TDI	2000	2015->	4	CAAC		Y-1002AS	8926		
CARAVELLE	2.0 BITDI	2000	2010->	4	CDBA		Y-1002AS	8926		
CARAVELLE	2.0 BITDI	2000	2011->	4	CNEA		Y-1002AS	8926		
CARAVELLE	2.0 BITDI	2000	2012->	4	CNFB		Y-1002AS	8926		
CARAVELLE	2.5 I	2500	1996->2003	5	AET	0,8	BUR6ET	3172		
CARAVELLE	2.5 TDI T4	2500	1995->2002	5	ACV		Y-732J	5909		
CARAVELLE	2.5 TDI T5	2500	2004->	5	AXE		Y-741U	5065		
CARAVELLE	2.5 TDI T5	2500	2003->	5	AXD		Y-741U	5065		
CARAVELLE	2.6 I	2600	1994->1998	5	ADV	0,8	BPR7ESZ-N	92591	BPR7ES	95164
CARAVELLE	2.8 VR6 T4	2800	1999->	6	AES	0,8	BKR5EKUP	2890	BKR5EKU	3964
CARAVELLE	3.2 T5	3200	2003->	5	BDL	0,8	IZKR7B	7563	ZKR7A-10	1691
CC	1.4 TSI	1400	2015->	4	CZDA	0,8	PZKER7B8EGS			
CC	1.8 TSI	1800	2011->	4	CDAA	0,8	PFR7S8EG	1675		
CC	2.0 TDI	2000	2011->	4	CFGB		Y-1002AS	8926		
CC	2.0 TDI	2000	2011->	4	CLLA		Y-1002AS	8926		
CC	2.0 TDI	2000	2012->	4	CFGC		Y-1002AS	8926		
CC	2.0 TSI	2000	2011->	4	CCZB	0,8	PFR7S8EG	1675		
CC	2.0 TURBO	2000	2009->	4	CCTA	0,8	PFR7S8EG	1675		
CC	3.6 FSI	3600	2011->	6	BWS	0,8	ILZKR8A	94290		
CRAFTER	2.0 TDI	2000	2011->	4	CKTB		Y-1002AS	8926		
CRAFTER	2.0 TDI	2000	2011->	4	CKUB		Y-1002AS	8926		
CRAFTER	2.0 TDI	2000	2011->	4	CKUC		Y-1002AS	8926		
CRAFTER	2.5 TDI	2500	2006->	5	BJJ		CZ104	9810		
CRAFTER	2.5 TDI	2500	2006->	5	BJK		CZ104	9810		
CRAFTER	2.5 TDI	2500	2006->	5	BJL		CZ104	9810		
CRAFTER	2.5 TDI	2500	2006->	5	BJM		CZ104	9810		
CREW BUS	1.9 TDI T5	1900	2003->	5	AXL		Y-741U	5065		
EOS	1.4 TFSI	1400	2007->	4	CAXA	0,8	PZFR6R	5758	ZFR6F-11	93208
EOS	1.4 TSI	1400	2008->2010	4	CAVD	0,8	PZFR6R	5758	ZFR6F-11	93208
EOS	2.0 FI TURBO	2000	2009->	4	BPY	0,8	PFR7S8EG	1675		
EOS	2.0 FSI	2000	2006->	4	BVY	1,1	PZFR5N-11T	7742		
EOS	2.0 TDI	2000	2008->2010	4	CBAB		Y-609AS	6074		
EOS	2.0 TFSI	2000	2006->2007	4	BWA	0,8	PFR6Q	6458	BKR6E	97737
EOS	2.0 TFSI	2000	2007->	4	CCTA	0,8	PFR7S8EG	1675		
EOS	2.0 TFSI	2000	2009->	4	CCZA	0,8	PFR7S8EG	1675		
EOS	3.2 V6	3200	2006->2007	6	BUB	0,8	IZKR7B	7563	ZKR7A-10	1691
FLEETLINE	1.6 1/2" REACH	1600		4	H,B,AD,AS	0,6	BP6HS	4511	BPR6HS	7022

VOLKSWAGEN



CAR • SUV • LCV



Model	Type	Capacity	Year	Cyl	Engine	Gap	Recommended	Stock Code	Alternative	Stock Code
VOLKSWAGEN										
FOX	1.3 FOX TRIPPA	1300	1987->1993	4	GY	0,8	BPR6ESZ-N	91711	BPR6ES	96989
FOX	1.6 L	1600	1987->1993	4	HM	0,8	BPR6ESZ-N	91711	BPR6ES	96989
FOX	1.8 L,SPORT	1800	1990->1995	4	EV	0,8	BPR7ESZ-N	92591	BPR7ES	95164
GOLF 1	1.1 L, LS, GL	1100	1978->1981	4	FA	0,8				
GOLF 1	1.3 CITI	1300	1995->	4	ET,GY	0,8	BPR6ESZ-N	91711	BPR6ES	96989
GOLF 1	1.3 CITI SHUTTLE	1300	1995->	4	GY	0,8	BPR6ESZ-N	91711	BPR6ES	96989
GOLF 1	1.3 CITI SONIC	1300	1995->	4	GY	0,8	BPR6ESZ-N	91711	BPR6ES	96989
GOLF 1	1.3 L, LS, GL	1300	1979->	4	GF, GL	0,8	BPR6ESZ-N	91711	BPR6ES	96989
GOLF 1	1.4 CHICO	1400	2001->	4	BBV	0,8	BPR6ESZ-N	91711	BPR6ES	96989
GOLF 1	1.4 I, CITI.COM, VELOCITI, STORM	1400	2001->	4	AGY	0,8	BPR7ESZ-N	92591	BPR7ES	95164
GOLF 1	1.5 GLS	1500	1979->1982	4	JB	0,8	BPR6ESZ-N	91711	BPR6ES	96989
GOLF 1	1.6 CITI SPORT, GTS	1600	1985->	4	FR, HM	0,8	BPR6ESZ-N	91711	BPR6ES	96989
GOLF 1	1.6 CITI SPORT, DECO, SONIC, BLUES	1600	1995->	4	HM	0,8	BPR7ESZ-N	92591	BPR7ES	95164
GOLF 1	1.6 GL	1600	1981->1985	4	CR		Y-918J	3704		
GOLF 1	1.6 I CHICO, LIFE, VELOCITI	1600	2001->	4	AFX	0,8	BPR7ESZ-N	92591	BPR7ES	95164
GOLF 1	1.8 CTI	1800	1990->	4	EV	0,8	BPR6ESZ-N	91711	BPR6ES	96989
GOLF 1	1.8 GTI	1800	1983->1985	4	DX	0,8	BPR6ESZ-N	91711	BPR6ES	96989
GOLF 2	16V 2.0	2000	1983->1993	4	AAL051V	0,8	BCPR7ES	93606	BCP7ES	5030
GOLF 2	1.3 CL	1300	1984->1987	4	GY	0,8	BPR6ESZ-N	91711	BPR6ES	96989
GOLF 2	1.6 CSL	1600	1984->1992	4	HM	0,8	BPR7ESZ-N	92591	BPR7ES	95164
GOLF 2	1.8 CSX	1800	1984->1992	4	HV	0,8	BPR7ESZ-N	92591	BPR7ES	95164
GOLF 2	1.8 GTI 16V	1800	1986->1990	4	KR	0,8	BCPR7ES	93606		
GOLF 2	1.8 GTI 8V	1800	1984->1992	4	EV	0,8	BPR6ESZ-N	91711	BPR6ES	96989
GOLF 2	2.0 GTI 16V	2000	1990->1993	4	AAL	0,8	BCPR7ES	93606		
GOLF 3	1.6 L	1600	1994->1997	4	ACG	0,8	BPR6ES	96989		
GOLF 3	1.6 L	1600	1992->1996	4	HM	0,8	BPR7ESZ-N	92591	BPR7ES	95164
GOLF 3	1.8 GSX, GTS	1800	1992->1996	4	ACH	0,8	BPR7ESZ-N	92591	BPR7ES	95164
GOLF 3	2.0 16V	2000	1992->1998	4	ABF	1	BKUR6ET-10	90599		
GOLF 3	2.0 8V	2000	1994->1996	4	ADY	0,8	BUR6ET	3172		
GOLF 3	2.0 GTI 8V	2000	1992->1996	4	2E/ AGG	0,8	BUR6ET	3172		
GOLF 3	2.8 VR6	2800	1992->1995	6	AAA	0,8	BKR5EKUD	6503		
GOLF 3	2.8 VR6	2800	1995->1997	6	AAA	0,8	BKR5EKUP	2890	BKR5EKU	3964
GOLF 4	1.6 COMFORTLINE	1600	1999->2004	4	AKL	1	BKUR6ET-10	90599		
GOLF 4	1.6 I	1600	1998->2004	4	AEH	1	BKUR6ET-10	90599		
GOLF 4	1.8 GTI	1800	2001->2004	4	AUQ	0,8	PFR6Q	6458	BKR6E	97737
GOLF 4	1.8 GTI TURBO	1800	2000->	4	AGU	0,8	PFR6Q	6458	BKR6E	97737
GOLF 4	1.8 HIGHLINE 20V	1800	1999->2000	4	AGN	1	BKUR6ET-10	90599		
GOLF 4	1.9 TDI HIGHLINE	1900	1999->2003	4	AHF		Y-732J	5909		
GOLF 4	2.0 HIGHLINE	2000	1999->2004	4	APK	1	BKUR6ET-10	90599		
GOLF 4	2.0I	2000	2001->2006	4	AZJ	1,1	PZFR5D-11	7968	ZFR5F-11	93814
GOLF 4	2.3 V5	2300	2001->	5	AGZ	0,8	BKR5EKUP	2890	BKR5EKU	3964
GOLF 4	2.8 VR6	2800	2001->	6	AQP,AUE	1,1	PZFR5D-11	7968	ZFR5F-11	93814
GOLF 5	1.4 FSI	1400	2006->2007	4	BUD	1,1	ZFR6T-11G	96211		
GOLF 5	1.4 FSI	1400	2007->	4	CAXA	0,8	PZFR6R	5758	ZFR6F-11	93208
GOLF 5	1.4 FSI	1400	2008->	4	EA111	1,1	ZFR6T-11G	96211		
GOLF 5	1.4 TSI BI-TURBO	1400	2005->	4	BLG	0,8	PZFR6R	5758	ZFR6F-11	93208
GOLF 5	1.6 FSI	1600	2003->2004	4	BAG	0,8	ZFR6S-Q	6449		
GOLF 5	1.6 FSI	1600	2004->2005	4	BGU	1	BKUR6ET-10	90599		
GOLF 5	1.6 FSI	1600	2004->2005	4	BLP	0,8	ZFR6S-Q	6449		
GOLF 5	1.6 FSI	1600	2007->	4	CCSA	1	BKUR6ET-10	90599		
GOLF 5	1.6 I	1600	2005->	4	BSF	1	BKUR6ET-10	90599		
GOLF 5	1.9 TDI	1900	2005->	4	BLS, BKC		Y-607AS	9776		
GOLF 5	2.0 8V	2000	2000->	4	BHY	1	BKUR6ET-10	90599		
GOLF 5	2.0 FSI	2000	2003->2004	4	AXW	1,1	PZFR5N-11T	7742		
GOLF 5	2.0 FSI	2000	2004->	4	BLY	0,8	BKR6E	97737		
GOLF 5	2.0 FSI	2000	2005->	4	BVZ	0,8	BKR6E	97737		
GOLF 5	2.0 FSI TURBO	2000	2004->2006	4	AXX	0,8	PFR6Q	6458	BKR6E	97737
GOLF 5	2.0 GTI	2000	2005->2007	4	BWA	0,8	PFR7S8EG	1675		
GOLF 5	2.0 GTI	2000	2006->	4	BYD	0,8	PFR7S8EG	1675		
GOLF 5	2.0 TDI	2000	2003->2007	4	BKD		YE14	5661		
GOLF 5	2.0 TDI	2000	2005->	4	BMN		CZ304	9835		
GOLF 5	3.2 R32	3200	2005->2007	6	BUB	0,8	IZKR7B	7563	ZKR7A-10	1691
GOLF 6	1.2 TFSI	1200	2013->	4	CBZA	0,7	IZFR6P-7	97153		
GOLF 6	1.2 TSI	1200	2013->	4	CBZB	0,7	IZFR6P-7	97153		
GOLF 6	1.4 FSI	1400	2008->2012	4	CGGA	1,1	ZFR6T-11G	96211		
GOLF 6	1.4 TSI	1400	2008->2012	4	CAVD	0,8	PZFR6R8EG	96498		
GOLF 6	1.4 TSI	1400	2008->2012	4	CAVD	0,8	SIZFR6B8EG	96209		
GOLF 6	1.4 TSI	1400	2008->2012	4	CAXA	0,8	PZFR6R	5758	ZFR6F-11	93208
GOLF 6	1.4 TSI	1400	2008->2012	4	CNWA	0,8	SIZFR6B8EG	96209		
GOLF 6	1.4 TSI	1400	2008->2012	4	CTHD	0,8	SIZFR6B8EG	96209		
GOLF 6	1.6 FSI	1600	2008->2012	4	CCSA	1	BKUR6ET-10	90599		
GOLF 6	1.6 FSI	1600	2009->2012	4	CHGA	1	BKUR6ET-10	90599		



CAR • SUV • LCV



Model	Type	Capacity	Year	Cyl	Engine	Gap	Recommended	Stock Code	Alternative	Stock Code
VOLKSWAGEN										
GOLF 6	1.6 FSI	1600	2010->2012	4	CMXA	1	BKUR6ET-10	90599	VOLKSWAGEN	
GOLF 6	1.6 TDI	1600	2008->2012	4	CAYB		Y-1002AS	8926		
GOLF 6	1.6 TDI	1600	2009->2012	4	CAYC		Y-1002AS	8926		
GOLF 6	1.8 TFSI	1800	2009->2012	4	CDAA	0,8	PFR7S8EG	1675		
GOLF 6	2.0 GTI	2000	2010->2012	4	CCZB	0,8	PFR7S8EG	1675		
GOLF 6	2.0 TDI	2000	2009->2012	4	CFHB,CFHC		Y-1002AS	8926		
GOLF 6	2.0 TFSI	2000	2009->2012	4	CCTA,CDLF	0,8	PFR7S8EG	1675		
GOLF 6	2.0 TFSI R	2000	2009->2012	4	CDLC	0,8	PFR7S8EG	1675		
GOLF 6	2.0 TFSI R	2000	2009->2013	4	CDLF	0,8	PFR7S8EG	1675		
GOLF 7	1.0 TSI	1000	2015->	3	CHZ	0,8	PKER7A8EGS	95463		
GOLF 7	1.2 TSI	1200	2012->	4	CJZB	0,8	PZKER7B8EGS			
GOLF 7	1.2 TSI	1200	2014->	4	CVVB	0,8	PZKER7B8EGS			
GOLF 7	1.4 TSI	1200	2014->	4	CPVB	0,8	PZKER7B8EGS			
GOLF 7	1.4 TSI	1400	2009->	4	CTKA	0,8	PZKER7B8EGS			
GOLF 7	1.4 TSI	1400	2012->	4	CMBA	0,8	PZKER7B8EGS			
GOLF 7	1.4 TSI	1400	2012->	4	CXSA	0,8	PZKER7B8EGS			
GOLF 7	1.4 TSI	1400	2014->	4	CHPB	0,8	PZKER7B8EGS			
GOLF 7	1.4 TSI	1400	2014->	4	CUKB	0,8	PZKER7B8EGS			
GOLF 7	1.4 TSI	1400	2014->	4	CZDA	0,8	PZKER7B8EGS			
GOLF 7	1.6 TDI	1600	2013->	4	CLHA		Y-1002AS	8926		
GOLF 7	2.0 GTI	2000	2013->	4	CHHB	0,8	PLFER7A8EG	94833		
GOLF 7	2.0 TDI	2000	2013->	4	CRBC		Y-1002AS	8926		
GOLF 7	2.0 TSI R	2000	2013->	4	CJXB	0,8	PLFER7A8EG	94833		
GOLF 7	2.0 TSI R	2000	2013->	4	CJXC	0,8	PLFER7A8EG	94833		
GOLF PLUS	1.6 FSI	1600	2006->	4	BLF	0,8	ZFR6S-Q	6449		
GOLF PLUS	2.0 I	2000	2006->	4	BLR, BVY	1,1	PZFR5N-11T	7742		
GOLF SV	1.2 TSI	1200	2015->	4	CJZA	0,8	PZKER7B8EGS			
GOLF SV	1.4 TSI	1400	2015->	4	CZCA	0,8	PZKER7B8EGS			
GOLF SV	2.0 TDI	2000	2015->	4	CRVA		Y-1002AS	8926		
JETTA 1	1.3 GL	1300	1980->1985	4	ET	0,8	BPR6ESZ-N	91711	BPR6ES	96989
JETTA 1	1.5 GLS	1500	1980->1985	4	JB	0,8	BPR6ESZ-N	91711	BPR6ES	96989
JETTA 1	1.6 GLX	1600	1980->1985	4	EM	0,8	BPR6ESZ-N	91711	BPR6ES	96989
JETTA 1	1.8 GLI	1800	1983->1985	4	DX	0,8	BPR7ESZ-N	92591	BPR7ES	95164
JETTA 2	16V 2.0	2000	1983->1993	4	AAL051V	0,8	BCPR7ES	93606	BCP7ES	5030
JETTA 2	1.6 CSL	1600	1985->1992	4	HM	0,8	BPR7ESZ-N	92591	BPR7ES	95164
JETTA 2	1.8 CLI 16V	1800	1987->1990	4	KR	0,8	BPR7ESZ-N	92591	BPR7ES	95164
JETTA 2	1.8 CLI 8V	1800	1985->1992	4	EV	0,8	BPR6ESZ-N	91711	BPR6ES	96989
JETTA 2	1.8 CSX	1800	1985->1993	4	HV	0,8	BPR7ESZ-N	92591	BPR7ES	95164
JETTA 2	2.0 16V	2000	1990->1992	4	AAL	0,8	BCPR7ES	93606		
JETTA 3	1.6 GSL	1600	1992->1996	4	HM	0,8	BPR7ESZ-N	92591	BPR7ES	95164
JETTA 3	1.6 L	1600	1992->1999	4	ACG	0,8	BPR6ES	96989		
JETTA 3	1.8 CLX	1800	1992->1996	4	ACH	0,8	BPR7ESZ-N	92591	BPR7ES	95164
JETTA 3	2.0 CLI	2000	1992->1996	4	2E/ AGG	0,8	BUR6ET	3172		
JETTA 3	2.8 VR6	2800	1992->1996	6	AAA	0,8	BKR5EKUP	2890	BKR5EKU	3964
JETTA 4	1.2 TSI	1200	2011->	4	CBZB	0,7	IZFR6P-7	97153		
JETTA 4	1.4 TSI	1400	2011->	4	CAXA/CMSB	0,8	PZFR6R	5758	ZFR6F-11	93208
JETTA 4	1.6 COMFORTLINE	1600	1999->	4	AKL	1	BKUR6ET-10	90599		
JETTA 4	1.6 I	1.6	2005->	4	BSF	1	BKUR6ET-10	90599		
JETTA 4	1.6 TDI	1600	2011->	4	CAYC		Y-1002AS	8926		
JETTA 4	1.6 TDI	1600	2011->	4	CFFB		Y-1002AS	8926		
JETTA 4	1.6 TDI	1600	2011->	4	CLC		Y-1002AS	8926		
JETTA 4	1.9 TDI	1900	1999->	4	AHF		Y-732J	5909		
JETTA 4	1.9 TDI	1900	2006->	4	BLS,BKC		Y-607AS	9776		
JETTA 4	2.0 FI TURBO	2000	2009->	4	CBFA	0,8	PFR7S8EG	1675		
JETTA 4	2.0 FSI	2000	2006->	4	BLR,BVY	1,1	PZFR5N-11T	7742		
JETTA 4	2.0 HIGHLINE	2000	1999->2002	4	APK	1	BKUR6ET-10	90599		
JETTA 4	2.0 TDI	2000	2006->	4	BLS,BKC		Y-607AS	9776		
JETTA 4	2.0 TSI	2000	2011->	4	CCZA	0,8	PFR7S8EG	1675		
JETTA 4	2.0 TURBO	2000	2006->	4	BWA	0,8	PFR7S8EG	1675		
JETTA 4	2.0 I	2000	2001->2006	4	AZJ	1,1	PZFR5D-11	7968	ZFR5F-11	93814
JETTA 4	2.3 V5	2300	1999->	5	AGZ	0,8	BKR5EKUP	2890	BKR5EKU	3964
JETTA 4	2.5 I	2500	2007->	5	CCCA	1,1	ZFR6T-11G	96211		
JETTA 6	1.2 TSI	1200	2012->	4	CBZA	0,7	IZFR6P-7	97153		
JETTA 6	1.2 TSI	1200	2014->	4	CYVD	0,8	PZKER7B8EGS			
JETTA 6	1.4 TSI	1400	2011->	4	CAVD	0,8	PZFR6R8EG	96498		
JETTA 6	1.4 TSI	1400	2011->2013	4	CAXA	0,8	PZFR6R	5758	ZFR6F-11	93208
JETTA 6	1.4 TSI	1400	2012->	4	CAXD	0,8	PZFR6R8EG	96498		
JETTA 6	1.4 TSI	1400	2014->	4	CZCZ	0,8	PZKER7B8EGS			
JETTA 6	1.4 TSI	1400	2014->	4	CZDA	0,8	PZKER7B8EGS			
KOMBI	1.8 L	1800	1989->	4	HV	0,8	BPR7ESZ-N	92591	BPR7ES	95164
KOMBI	1.8 PANEL VAN	1800	1989->	4	AP	0,8	BPR6ESZ-N	91711	BPR6ES	96989
LT	LT35 2.8 TD	2800	1996->	5	AGX		Y-732J	5909		

VOLKSWAGEN



CAR • SUV • LCV



Model	Type	Capacity	Year	Cyl	Engine	Gap	Recommended	Stock Code	Alternative	Stock Code
VOLKSWAGEN										
LUPO	1.4 I	1400	2002->2005	4	BBY	0,8	BKUR6ET-10	90599		
MICROBUS	1.6 1/2" REACH	1600		4	H,B,AD,AS	0,6	BP6HS	4511	BPR6HS	7022
MICROBUS	1.7 3/4" REACH	1700		4	CA,CE	0,8	BPR6ESZ-N	91711	BPR6ES	96989
MICROBUS	1.8 3/4" REACH	1800		4	AP	0,8	BPR6ESZ-N	91711	BPR6ES	96989
MICROBUS	1.9 WATER COOLED	1900		4	DG	0,8	BPR6ESZ-N	91711	BPR6ES	96989
MICROBUS	2.0 L	2000		4	CJ,CU	0,8	BPR6ESZ-N	91711	BPR6ES	96989
MICROBUS	2.1 I SYNCRO	2100	1989->1993	4	DJ	0,8	BPR6ESZ-N	91711	BPR6ES	96989
MICROBUS	2.1 I TURBO	2100		4	ALPINE	0,8	BPR6ESZ-N	91711	BPR6ES	96989
MICROBUS	2.3 I	2300	1995->	5	AFU	0,8	BPR7ESZ-N	92591	BPR7ES	95164
MICROBUS	2.5 I	2500	1991->1995	5	AAY	0,8	BPR7ESZ-N	92591	BPR7ES	95164
MICROBUS	2.6 I	2600	1994->1996	5	ADV	0,8	BPR7ESZ-N	92591	BPR7ES	95164
PASSAT	1.3 L,LS	1300	1974->1981	4	ZF	0,8	BPR6ESZ-N	91711	BPR6ES	96989
PASSAT	1.6 GLS	1600	1979->1981	4	YP,YN	0,8	BPR6ESZ-N	91711	BPR6ES	96989
PASSAT	1.8 CL	1800	1984->1987	4	JV,HV	0,8	BPR7ESZ-N	92591	BPR7ES	95164
PASSAT	1.9 GLS	1900	1981->1985	5	WN	0,8	BPR7ESZ-N	92591	BPR7ES	95164
PASSAT	1.9 TDI	1900	2001->	4	AFN,AJM,1Z,AHU,		Y-732J	5909		
PASSAT	2.2 CLI	2200	1985->1987	5	SG	0,8	BPR7ESZ-N	92591	BPR7ES	95164
PASSAT	2.2 CLX	2200	1984->1987	5	MX	0,8	BPR7ESZ-N	92591	BPR7ES	95164
PASSAT	2.3 V5	2300	2003->	4	AZX	1	BKUR5ETC-10	90531		
PASSAT 3	2.8 V6	2800	1991->1995	6	AAA	0,8	BKR5EQU	3964		
PASSAT 4	1.8 TURBO	1800	1999->	4	AEB	0,8	PFR6Q	6458	BKR6E	97737
PASSAT 4	1.8 TURBO	1800	2000->	4	AFY	1	BKUR6ET-10	90599		
PASSAT 4	1.8 TURBO	1800	2005->	4	AWT	0,8	PFR6Q	6458	BKR6E	97737
PASSAT 4	1.9 TDI	1900	1999->2000	4	AVG		Y-732J	5909		
PASSAT 4	2.0 FSI	2000	2005->	4	AZM	1	BKUR6ET-10	90599		
PASSAT 4	2.3 I	2300	1997->2000	5	AGZ	0,8	BKR5EKUP	2890	BKR5EQU	3964
PASSAT 4	2.3 I	2300	2001->2005	5	AZX	1,1	PZFR5D-11	7968	ZFR5F-11	93814
PASSAT 4	2.8 V6	2800	1999->	6	ACK	0,8	BKR6EKUB	3584		
PASSAT 4	2.8 V6	2800	2001->	6	AMX	0,8	BKR6EKUB	3584		
PASSAT 4	2.8 V6	2800	2005->	6	BBG	0,8	BKR6EKUB	3584		
PASSAT 5	1.6 I	1600	2005->	4	BLF	0,8	ZFR6S-Q	6449		
PASSAT 5	1.8 TSI	1800	2009->	4	CDA	0,8	PFR7S8EG	1675		
PASSAT 5	1.8 TSI	1800	2012->	4	CDA	0,8	PFR7S8EG	1675		
PASSAT 5	1.9 TDI	1900	2003->2005	4	AVF		Y-741U	5065		
PASSAT 5	2.0 FI TURBO	2000	2009->	4	CCTA	0,8	PFR7S8EG	1675		
PASSAT 5	2.0 FSI	2000	2005->	4	BLR	1,1	PZFR5N-11T	7742		
PASSAT 5	2.0 FSI	2000	2005->	4	BLY	0,8	BKR6E	97737		
PASSAT 5	2.0 FSI	2000	2005->	4	BVZ	0,8	BKR6E	97737		
PASSAT 5	2.0 FSI	2000	2005->2007	4	BPY,BWA	0,8	PFR6Q	6458	BKR6E	97737
PASSAT 5	2.0 FSI	2000	2005->2007	4	BVX,BVY	1,1	PZFR5N-11T	7742		
PASSAT 5	2.0 FSI TURBO	2000	2005->	4	AXX	0,8	PFR6Q	6458	BKR6E	97737
PASSAT 5	2.0 TDI	2000	2005->	4	BMP		CZ104	9810		
PASSAT 5	2.0 TDI	2000	2005->	4	BMR		CZ304	9835		
PASSAT 5	2.0 TDI	2000	2005->2007	4	BKP		CZ304	9835		
PASSAT 5	2.0 TDI	2000	2007->2010	4	BKP		YE14	5661		
PASSAT 5	2.0 TDI	2000	2008->	4	CBAA,CBBB		Y-609AS	6074		
PASSAT 5	2.0 TDI	2000	2010->	4	CFFB		Y-1002AS	8926		
PASSAT 5	2.0 TFSI	2000	2007->2010	4	CAWB	0,8	PFR7S8EG	1675		
PASSAT 5	3.2 FSI	3200	2005->2007	6	AXZ	0,8	ILZKR7A	1961	LZKAR7A	6799
PASSAT 5	3.6 FSI	3600	2005->2007	6	BLV	0,8	ILZKR7A	1961	LZKAR7A	6799
PASSAT 5	3.6 R36	3600	2007->	6	BWS	0,8	ILZKR8A	94290		
PASSAT 6	1.4 TSI	1400	2014->	4	CZCA	0,8	PZKER7B8EGS			
PASSAT 6	1.4 TSI	1400	2014->	4	CZDA	0,8	PZKER7B8EGS			
PASSAT 6	2.0 TFSI	2000	2015->	4	CHHB	0,8	PLFER7A8EG	94833		
PHAETON	3.2 V6	3200	2002->	6	AYT	0,8	IZKR7B	7563	ZKR7A-10	1691
PHAETON	3.2 V6	3200	2003->	6	BKL	0,8	IZKR7B	7563	ZKR7A-10	1691
PHAETON	4.2 FSI	4200	2003->	8	BGH	0,8	BKR6EQUA	6872		
PHAETON	4.2 FSI	4200	2003->	8	BGJ	0,8	BKR6EQUA	6872		
PHAETON	6.0 FSI	6000	2003->	12	BAP	1,1	PZFR6J-11	3586	ZFR6F-11	93208
PHAETON	6.0 FSI	6000	2005->	12	BAN	1,1	PZFR6J-11	3586	ZFR6F-11	93208
PICK-UP	1.6 SX	1600	1997->	4	H,B,AD,AS	0,8	BPR6ESZ-N	91711	BPR6ES	96989
PICK-UP	1.8 SPORT	1800	1997->	4	AP	0,8	BPR7ESZ-N	92591	BPR7ES	95164
POLO	1.0 TSI	1000	2015->	3	CHZD	0,8	PKER7A8EGS	95463	PZKER7B8EGS	
POLO	1.2 I	1200	2009->	4	BBM	0,8	ZFR5P-G	6893		
POLO	1.2 I	1200	2009->	4	BZG	0,8	ZFR5P-G	6893		
POLO	1.2 I	1200	2010->	3	CJLA	0,8	ZFR5P-G	6893		
POLO	1.2 TDI	1200	2009->	3	CFWA		Y-1002AS	8926		
POLO	1.2 TSI	1200	2009->	4	CBZA	0,7	IZFR6P-7	97153		
POLO	1.2 TSI	1200	2013->	4	CJZA	0,8	PZKER7B8EGS			
POLO	1.4 16V	1400	2005->	4	BKY	0,8	ZFR5P-G	6893		
POLO	1.4 COMFORTLINE	1400	2011->	4	CGGB	1,1	ZFR6T-11G	96211		
POLO	1.4 FSI	1400	2002->2005	4	AXU	0,8	ZFR6S-Q	6449		



CAR • SUV • LCV



Model	Type	Capacity	Year	Cyl	Engine	Gap	Recommended	Stock Code	Alternative	Stock Code
VOLKSWAGEN										
POLO	1.4 GTI	1400	2010->	4	CAVE	0,8	PZFR6R	5758	ZFR6F-11	93208
POLO	1.4 GTI	1400	2012->	4	CTHE	0,8	PZFR6R8EG	96498		
POLO	1.4 I	1400	2006->	4	BUD	1,1	ZFR6T-11G	96211		
POLO	1.4 I	1400	2009->	4	CGGB	1,1	ZFR6T-11G	96211		
POLO	1.4 I	1600	2006->	4	BTS	1,1	ZFR6T-11G	96211		
POLO	1.4 I 16V	1400	2001->2004	4	BBC,BBY	1	BKUR6ET-10	90599		
POLO	1.4 TDI	1400	2001->	3	BAY		Y-732J	5909		
POLO	1.4 TDI	1400	2006->	3	BWB		CZ104	9810		
POLO	1.4 TSI	1400	2013->	4	CMBA	0,8	PZKER78EGS			
POLO	1.4 VIVO	1390	2016->	4	CLPB	1,1	ZFR6T-11G	96211		
POLO	1.6 COMFORTLINE	1600	2011->	4	CLS	1,1	ZFR6T-11G	96211		
POLO	1.6 I	1600	1999->2001	4	AKL	1	BKUR6ET-10	90599		
POLO	1.6 I	1600	2006->	4	BTS	1,1	ZFR6T-11G	96211		
POLO	1.6 TDI	1600	2009->	4	CAYA		Y-1002AS	8926		
POLO	1.6 TDI	1600	2009->	4	CAYA,CAYB,CAYC		Y-1002AS	8926		
POLO	1.6 TDI	1600	2009->	4	CAYB		Y-1002AS	8926		
POLO	1.6 TDI	1600	2009->	4	CAYC		Y-1002AS	8926		
POLO	1.6 TDI	1.6	2009->	4	CLNA		Y-1002AS	8926		
POLO	1.8 GTI	1800	2006->	4	BBU,BJX	0,8	PFR6Q	6458	BKR6E	97737
POLO	1.8 GTI	1800	2014->	4	DAJA	0,8	PLFER7A8EG	94833		
POLO	1.8 GTI	1800	2014->	4	DAJB	0,8	PLFER7A8EG	94833		
POLO	1.9 D	1900	1994->1999	4	AEF		Y-918J	3704		
POLO	1.9 TDI	1900	2004->2005	4	ASZ,BLT,ATB		Y-741U	5065		
POLO	1.9 TDI	1900	2006->	4	BMT		Y-607AS	9776		
POLO CLASSIC	1.4 I	1400	1996->2002	4	AGY	0,8	BPR6ESZ-N	91711	BPR6ES	96989
POLO CLASSIC	1.4 I	1400	2007->	4	BLM	1	BKUR5ETC-10	90531		
POLO CLASSIC	1.4 TDI	1400	2002->2005	4	AMF		Y-741U	5065		
POLO CLASSIC	1.6 I	1600	1996->2002	4	AFX	0,8	BPR7ESZ-N	92591	BPR7ES	95164
POLO CLASSIC	1.6 I COMFORTLINE	1600	2002->2007	4	BAH	1	BKUR5ETC-10	90531		
POLO CLASSIC	1.8 I	1800	1996->2002	4	AFV	0,8	BPR7ESZ-N	92591	BPR7ES	95164
POLO CLASSIC	1.9 TDI	1900	2003->2005	4	ATD,AXR		Y-741U	5065		
POLO CLASSIC	2.0 I	2000	2004->	4	BBX	1	BKUR6ET-10	90599		
POLO PLAYA	1.4 I	1400	1998->2002	4	AGY	0,8	BPR6ESZ-N	91711	BPR6ES	96989
POLO PLAYA	1.6 I	1600	1998->2002	4	AFX	0,8	BPR7ESZ-N	92591	BPR7ES	95164
POLO PLAYA	1.8 I	1800	1999->2002	4	AFV	0,8	BPR7ESZ-N	92591	BPR7ES	95164
POLO VIVO	1.4 I	1400	2011->	4	CLP	1,1	ZFR6T-11G	96211		
POLO VIVO	1.6 I	1600	2011->	4	CLS	1,1	ZFR6T-11G	96211		
SANTANA	1.6 TDI	1600	1981->1984	4			Y-918J	3704		
SCIROCCO	1.4 TSI	1400	2008->	4	CAVD	0,8	PZFR6R	5758	ZFR6F-11	93208
SCIROCCO	1.8 TFSI	1800	2008->	4	CAXA	0,8	PZFR6R	5758	ZFR6F-11	93208
SCIROCCO	2.0 TFSI	2000	2008->	4	CAWB	0,8	PFR7S8EG	1675		
SCIROCCO	2.0 TFSI	2000	2013->	4	CULC	0,8	PLFER7A8EG	94833		
SCIROCCO	2.0 TSI	2000	2009->	4	CCZB	0,8	PFR7S8EG	1675		
SCIROCCO	2.0 TSI-R	2000	2009->	4	CDLA	0,8	PFR7S8EG	1675		
SCIROCCO	2.0 TSI R	2000	2009->	4	CDLC	0,8	PFR7S8EG	1675		
SHARAN	1.4 TSI	1400	2010->	4	CAVA	0,8	PZFR6R	5758	ZFR6F-11	93208
SHARAN	1.4 TSI	1400	2015->	4	CZDA	0,8	PZKER7B8EGS			
SHARAN	1.8 TURBO	1800	1999->2001	4	AJH	0,8	BKUR6ET-10	90599		
SHARAN	1.8 TURBO	1800	2000->2005	4	AWC	0,8	PFR6Q	6458	BKR6E	97737
SHARAN	1.9 TDI	1900	2003->2006	4	AUY		Y-741U	5065		
SHARAN	2.0 I	2000	2005->	4	ATM	1	BKUR6ET-10	90599		
SHARAN	2.0 TSI	2000	2010->	4	CCZA	0,8	PFR7S8EG	1675		
SHARAN	2.0 TSI	2000	2015->	4	DEDA	0,8	PLFER7A8EG	94833		
SHARAN	2.8 VR6	2800	2000->	6	AMY,AAA	0,8	BKR5EKUP	2890	BKR5EKU	3964
SHARAN	2.8 VR6	2800	2005->	6	AVL	1,1	PZFR5D-11	7968	ZFR5F-11	93814
T5	1.9 T5 PANEL VAN	1900	2003->	4	ABL		Y-918J	3704		
T5	1.9 TDI	1900	2006->	4	BRS,BRR		Y-607AS	9776		
T5	1.9 TDI T5	1900	2003->2007	5	AXB		Y-741U	5065		
T5	2.0 TDI	2000	2009->	4	CCHA		Y-1002AS	8926		
T5	2.5 TDI	2500	2006->2007	5	AXE		Y-741U	5065		
T5	2.5 TDI	2500	2006->2007	5	BPC, BNZ		CZ104	9810		
T5	3.2 V6	3200	2004->2007	6	BDL,BKK	0,8	IZKR7B	7563	ZKR7A-10	1691
TIGUAN	1.4 FSI	1400	2007->2008	4	BWK	0,8	PZFR6R	5758	ZFR6F-11	93208
TIGUAN	1.4 TSI	1400	2008->	4	CAVA	0,8	PZFR6R	5758	ZFR6F-11	93208
TIGUAN	1.4 TSI	1400	2010->2012	4	CAXA	0,8	PZFR6R	5758	ZFR6F-11	93208
TIGUAN	1.4 TSI	1400	2012->	4	CAXD	0,8	PZFR6R8EG	96498		
TIGUAN	1.4 TSI	1400	2015->	4	CZDA	0,8	PZKER7B8EGS			
TIGUAN	1.4 TSI	1400	2015->	4	CZDB	0,8	PZKER7B8EGS			
TIGUAN	2.0 FI TURBO	2000	2009->	4	CCTA	0,8	PFR7S8EG	1675		
TIGUAN	2.0 TDI	2000	2007->2010	4	CBAA		Y-609AS	6074		
TIGUAN	2.0 TDI	2000	2010->	4	CFDD		Y-1002AS	8926		
TIGUAN	2.0 TDI	2000	2010->	4	CLJA		Y-1002AS	8926		
TIGUAN	2.0 TSI	2000	2011->	4	CCZB	0,8	PFR7S8EG	1675		

VOLKSWAGEN



CAR • SUV • LCV



Model	Type	Capacity	Year	Cyl	Engine	Gap	Recommended	Stock Code	Alternative	Stock Code
VOLKSWAGEN										
TOUAREG	2.5 TDI	2500	2004->	5	BLK		Y-741U	5065	VOLKSWAGEN	
TOUAREG	2.5 TDI	2500	2005->	5	BPD					
TOUAREG	3.0 TDI	3000	2007->	6	CASA		Y-609AS	6074		
TOUAREG	3.0 TDI	3000	2008->	6	CASC		Y-609AS	6074		
TOUAREG	3.2 FSI	3200	2002->2006	6	AZZ,BMV	0,8	IZKR7B	7563	ZKR7A-10	1691
TOUAREG	3.6 FSI	3600	2006->	6	BHK	0,8	ILZKR7A	1961	LZKAR7A	6799
TOUAREG	4.2 FSI	4200	2006->2009	8	BAR	0,8	PFR6W-T	6740		
TOUAREG	4.2 V8	4200	2002->2006	8	AXQ,BHX	0,8	BKR6EQUA	6872		
TOUAREG	4.9 TDI	4900	2004->	10	BLE		CZ104	9810		
TOUAREG	5.0 TDI V10	5000	2002->2006	10	AYH		Y-741U	5065		
TOUAREG	6.0 WR12	6000	2004->	12	BJN	1,1	PZFR6J-11	3586	ZFR6F-11	93208
TOURAN	1.2 TFSI	1200	2010->	4	CBZB	0,7	IZFR6P-7	97153		
TOURAN	1.4 TFSI	1400	2006->	4	BMV/CAVC	0,8	PZFR6R	5758	ZFR6F-11	93208
TOURAN	1.4 TSI	1400	2015->	4	CZDA	0,8	PZKER7B8EGS			
TOURAN	1.6 TRENDLINE	1600	2005->	4	BSE,BSF	1	BKUR6ET-10	90599		
TOURAN	1.8 TSI	1800	2015->	4	CJSA	0,8	PLFER7A8EG	94833		
TOURAN	1.9 TDI	1900	2003->2006	4	BKC		Y-607AS	9776		
TOURAN	2.0 FSI	2000	2004->	4	AXW	1,1	PZFR5N-11T	7742		
TOURAN	2.0 TDI	2000	2005->	4	BMN		CZ304	9835		
TOURAN	2.0 TDI	2000	2010->	4	CLCA		Y-1002AS	8926		
TOUAREG	3.0 V6 TDI	3000	2012->	6	CRCA		Y-1002AS	8926		
TOUAREG	3.6 FSI	3600	2010->	6	CGRA	0,8	ILZKR7A	1961	LZKAR7A	6799
TOUAREG	4.1 V8 TDI	4200	2012->	8	CKDA		Y-1002AS	8926		
TRANSPORTER	1.6 1/2" REACH	1600		4	H,B,AD,AS	0,6	BP6HS	4511	BPR6HS	7022
TRANSPORTER	1.9 TDI	1900	2003->	4	AXB		Y-741U	5065		
TRANSPORTER	2.0 BITDI	2000	2009->	4	CFCA		Y-1002AS	8926		
TRANSPORTER	2.0 I	2000	2003->2007	4	AXA	1	BKUR6ET-10	90599		
TRANSPORTER	2.0 TDI	2000	2009->	4	CCHA		Y-1002AS	8926		
TRANSPORTER	2.0TDI	2000	2009->	4	CAAB		Y-1002AS	8926		
TRANSPORTER	2.5 TDI	2500	2003->	5	AXD		Y-741U	5065		
TRANSPORTER	3.2 I	3200	2005->	6	BKK	0,8	IZKR7B	7563	ZKR7A-10	1691
TRANSPORTER	3.2 T4	3200	2005->	6	BDL	0,8	IZKR7B	7563	ZKR7A-10	1691
UP	1.0 I	1000	2015->	3	CHYB	1	ZKER6A-10EG	96596		

VOLVO										
850	2.3 TURBO SPORTWAGON	2300	1994->	5	B5234FT	0,8	BCPR7ET	2164		
850	2.5 GLT, GLT SPORTWAGON	2500	1994->	5	B5254F	0,8	BCPR6ES	96990	BCP6ES	94000
850	2.5 R	2500	1996->1997	5	B5234T5	1,1	BCPR7EIX-11	5691		
940	2.4 TD INTERC., KOMBI	2400	1994->	6	D24T		Y-918J	3704		
960	2.4 TD INTERC.	2400	1991->	6	D24TIC		Y-918J	3704		
960	2.9 SEDAN-ESTATE	2900	1994->1997	5	B6304FS	0,8	BCPR6ES	96990	BCP6ES	94000
C30	1.6 D2	1600	2006->	4	D4164T		YE04	1101		
C30	1.6 I	1600	2006->	4	B4164S3	1,3	TR6B-13	97667		
C30	2.0 16V	2000	2006->	4	B4204S3	1,3	TR6AP-13E	4968		
C30	2.0 16V	2000	2007->	4	B4204S	0,8	PFR6B	3500	BKR6E	97737
C30	2.4 16V	2400	2006->	5	B5244S4	0,8	LFR6D	4704		
C30	2.5 T5	2500	2006->	5	B5254T3	0,8	ILFR6B	6481	LFR6B	6677
C30	2.5 T5	2500	2006->	5	B5254T7	0,8	ILFR6B	6481		
C70	2.3 CABRIO T5	2300	2002->	5	B5234T3	0,8	PFR6B	3500	BKR6E	97737
C70	2.4 I	2500	2006->	5	B5244S4,5	0,8	LFR6D	4704		
C70	2.5 I	2500	2002->	5	B5254	0,8	BKR6EKUB	3584		
C70	2.5 I	2500	2005->	5	B5254T7	0,8	ILFR6B	6481	LFR6B	6677
C70	2.5 I	2500	2006->	5	B5254T3	0,8	ILFR6B	6481	LFR6B	6677
S40	1.6 D2	1600	2012->	4	D4164T		YE04	1101		
S40	1.8 I	1800	2004->	4	B4184S8 / S11	1,3	ITR6F-13	4477	BPR6EFS-15	4871
S40	1.9 D	1900	1996->	4	D4192T		Y-933J	6599		
S40	1.9 D	1900	2000->	4	D4192T3/DI		Y-732J	5909		
S40	1.9 T4	1900	1998->	4	B4194T	1,1	PFR6G-11	5555	BKR6E-11	94306
S40	2.0 16V	2000	1997->2005	4	B4204S2	0,8	BCPR6ET	2197		
S40	2.0 16V	2000	2006->	4	B4204S3	1,3	TR6AP-13E	4968		
S40	2.0 T4	2000	2000->2003	4	B4204T5	0,8	BKR6EIX	6418		
S40	2.0 TURBO	2000	1997->2003	4	B4204T3	0,8	BKR6EIX	6418		
S40	2.0 TURBO	2000	1999->	4	B4204T	0,8	PFR6B	3500	BKR6E	97737
S40	2.4 I	2400	2004->	5	B5244S4,S5	0,8	LFR6D	4704		
S40	2.5 I	2500	2005->	5	B5254T3,T5	1,1	PLFR6A-11	7654		
S40	2.5 T5	2500	2007->	5	B5254T7	0,8	ILFR6B	6481	LFR6B	6677
S60	1.6 T3	1600	2011->	4	B4164T3	0,8	ILZTR6A-8G	94769		
S60	1.6 T4	1600	2011->	4	B4164T	0,8	ILZTR6A-8G	94769		
S60	2.0 D3	2000	2010->	4	D5204T2/T3		Y-8008AS	97199		
S60	2.0 D3	2000	2011->	5	D5204T2/T3		Y-8008AS	97199		
S60	2.0 D4	2000	2012->	4	D5204T2/T3		Y-8008AS	97199		
S60	2.0 T5	2000	2012->	4	B4204T7	0,8	ILTR6G-8G	96621		



CAR • SUV • LCV

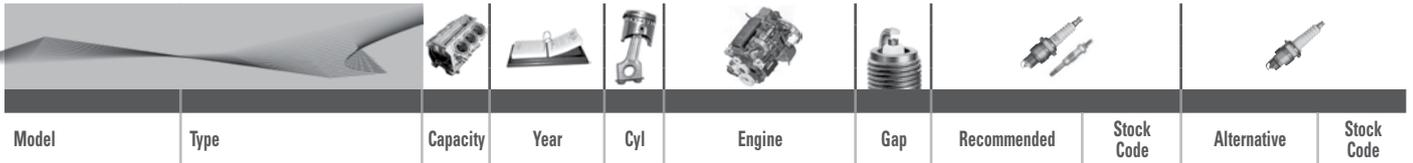

Model	Type	Capacity	Year	Cyl	Engine	Gap	Recommended	Stock Code	Alternative	Stock Code
VOLVO										
S60	2.0 T6	2000	2012->	4	B4204 T9	0,6	ILKAR8H-6	96024		
S60	2.0 TURBO	2000	2003->	5	B5204T5	0,8	PFR6B	3500	BKR6E	97737
S60	2.0 TURBO	2000	2004->	5	B5204T	1,1	PLFR6A-11	7654		
S60	2.3 I T5	2300	2001->	5	B5234T3	0,8	PFR6B	3500	BKR6E	97737
S60	2.4 D	2400	2002->	5	D5244T		YE12	7794		
S60	2.4 I	2400	2001->	5	B5244S	0,8	PFR6W-TG	5547		
S60	2.4 TURBO	2400	2001->	5	B5244T	0,8	PFR6B	3500	BKR6E	97737
S60	2.5 D5	2400	2011->	5	D5244T11/ T15		Y-8008AS	97199		
S60	2.5 TURBO	2500	2004->	5	B5254T2	0,8	PFR6B	3500	BKR6E	97737
S60	S60 POLESTAR	1969	2015->	4	B4204T43	0,8	ILTR6G-8G	96621		
S60R	2.5 TURBO	2500	2003->	5	B5254T4	1,1	PLFR6A-11	7654		
S70	2.3 T-5	2300	1997->	5	B5234T4	0,8	PFR6B	3500	BKR6E	97737
S70	2.5 20V	2500	1994->	5	B5254S	0,8	BKR6E	97737		
S80	2.0 16V	2000	2007->	4	B4204S3 / S4	1,3	ITR6F-13	4477	BPR6EFS-15	4871
S80	2.4 D5	2400	2009->	5	D5244T4		Y-8008AS	97199		
S80	2.5 TURBO	2500	2006->	5	B5254T2,T5	0,8	ILFR6B	6481	LF6B	6677
S80	2.5 TURBO	2500	2007->	5	B5254 T6 / T8	0,8	ILFR6K-8	94040		
S80	2.8 I T6	2800	1999->	6	B6284T2	0,8	BCPR7ES	93606		
S80	2.9 I	2900	1999->	6	B6294S	0,8	BKR6EKUB	3584		
S80	3.0 T6	3000	2001->2006	6	B6294T	0,8	PFR6B	3500	BKR6E	97737
S80	3.2 I	3200	2007->	6	B6324S	0,8	ILFR6B	6481	LF6B	6677
S90	3.0 I	3000	1997->2000	5	B6304F	0,8	BCPR6ES	96990	BCP6ES	94000
V40	1.6 T3	1600	2012->	4	B4164T3	0,8	ILZTR6A-8G	94769		
V40	1.6 T4	1600	2012->	4	B4164T	0,8	ILZTR6A-8G	94769		
V40	1.9 D	1900	1996->	4	D4192T		Y-933J	6599		
V40	1.9 DCI	1900	2000->	4	DCI RENAULT		Y-732J	5909		
V40	1.9 T4	1900	1998->	4	B4194 T	1,1	PFR6G-11	5555	BKR6E-11	94306
V40	2.0 S/WAGON	2000	1997->	4	B4204S	0,8	BCPR6ET	2197		
V40	2.0 T5	2000	2000->2004	4	B4204T5	1,1	BKR6EP-11	2978	BKR6E-11	94306
V50	2.0 16V	2000	2007->	4	B4204S3	1,3	ITR6F-13	4477	BPR6EFS-15	4871
V50	2.4 L5	2400	2005->	5	B5244S7	0,8	LF6B	4704		
V50	2.5 T5	2500	2004->	5	B5254T3	1,1	ILFR6B	6481	LF6B	6677
V50	2.5 T5	2500	2007->	5	B5254T7	0,8	ILFR6B	6481	LF6B	6677
V60	1.6 T3	1600	2011->	4	B4164T3	0,8	ILZTR6A-8G	94769		
V60	1.6 T4	1600	2011->	4	B4164T	0,8	ILZTR6A-8G	94769		
V60	2.0 D3	2000	2010->	4	D5204T2/T3		Y-8008AS	97199		
V60	2.0 D4	2000	2012->	4	D5204T2/T3		Y-8008AS	97199		
V60	2.0 T5	2000	2010->	4	B4204T7	0,8	ILTR6G-8G	96621		
V60	2.0 T6	2000	2012->	4	B4204 T9	0,6	ILKAR8H-6	96024		
V60	2.4 D5	2400	2011->	4	D5244T11/T15		Y-8008AS	97199		
V60	3.0 T6	3000	2012->	6	B6304 T3	1,1	DILFR6J-11	92491		
V60	T4	1969	2015->	4	B4204T19	0,8	ILTR6G-8G	96621		
V70	2.0 16V	2000	2007->	4	B4204S3 / S4	1,3	ITR6F-13	4477	BPR6EFS-15	4871
V70	2.0 TURBO	2000	2003->	5	B5204T	0,8	BCPR7ES	93606		
V70	2.3 T-5 S/WAGON	2300	1997->	5	B5234T4	0,8	BCPR7ES	93606		
V70	2.4 T4	2400	1997->2001	5	B5244T	0,8	BKR7EIX	2667	BCPR7ES	93606
V70	2.4 TURBO	2400	2000->	5	B5244T3	0,8	PFR6B	3500	BKR6E	97737
V70	2.5 20V	2500	1994->	5	B5254S	0,8	BKR6E	97737		
V70	2.5 R	2500	2004->	5	B5254T4	1,1	PLFR6A-11	7654		
V70	2.5 T6	2500	2007->	5	B5254T6	0,8	ILFR6K-8	94040		
V70	3.0 TURBO	3000	2007->	5	B6304T2	0,8	ILFR6B	6481	LF6B	6677
V70	3.2 V6	3200	2007->	6	B6324S	0,8	ILFR6B	6481	LF6B	6677
V90	2.9 S/WAGON	2900	1997->2000	6	B6304F	0,8	BCPR6ES	96990	BCP6ES	94000
V90	3.0 V6	3000	1997->	6	B6304F/G	0,8	BKR6EKUB	3584		
XC60	2.0 D3	2000	2008->	4	D5244T5/T16		Y-8008AS	97199		
XC60	2.0 D4	2000	2011->2014	4	D5204T2		Y-8008AS	97199		
XC60	2.0 T5	2000	2011->	4	B4204T7	0,8	ILTR6G-8G	96621		
XC60	2.0 T6	2000	2010->	4	B4204T6	0,8	ILTR6G-8G	96621		
XC60	2.4 TD D5	2400	2010->	5	D5244T4		Y-8008AS	97199		
XC60	2.5 D5	2400	2011->	5	D5244T11		Y-8008AS	97199		
XC60	3.0 I	3000	2008->	6	B6304T2	0,8	ILFR6B	6481	LF6B	6677
XC70	2.4 D5	2400	2003->	5	D5244T		YE12	7794		
XC70	2.4 TURBO	2400	2003->	5	B5244T3	0,8	BKR6EIX	6418		
XC70	2.5 D5	2400	2011->	5	D5244T11		Y-8008AS	97199		
XC70	2.5 TURBO	2500	2003->	5	B5254T2	0,8	ILFR6B	6481	LF6B	6677
XC70	3.2 TURBO	3200	2007->	6	B6324S	0,8	ILFR6B	6481	LF6B	6677
XC90	2.4 D5	2400	2003->	5	D5244T		YE12	7794		
XC90	2.5 D5	2400	2010->	5	D5244T18		Y-8008AS	97199		
XC90	2.5 T5	2500	2002->	5	B5254T2	0,8	BKR6EIX	6418	BKR6E	97737
XC90	2.9 T6	2900	2003->	6	B6294T	0,8	BKR6EIX	6418	BKR6E	97737
XC90	3.2 TURBO	3200	2006->	6	B6324S	0,8	ILFR6B	6481	LF6B	6677
XC90	4.4 V8	4400	2005->	8	B8444S	1,1	IFR6D-10	5344	BKR6E-11	94306

VOLVO



Model	Type	Capacity	Year	Cyl	Engine	Gap	Recommended	Stock Code	Alternative	Stock Code
-------	------	----------	------	-----	--------	-----	-------------	------------	-------------	------------

AVIA										AVIA
A21.1	D		1990->	4			Y-208T	1250		
AVIA	3.6D	3600	1993->1993	4	D407		Y-208T	1250		

BEDFORD										BEDFORD
97000	2.0D SERIES	2000	1979->1980	4			Y-208T	1250		

CITROEN										CITROEN
BX17	1.8D	1800	1985->1993	4	XUD 7		Y-924J	3473		
C25	2.5D	2500	1981->1994	4	CRD93		Y-208T	1250		
C32	2.2D	2200	1979->	4	CRD90		Y-208T	1250		
C35	2.5D	2500	1980->1991	4	CRD93B		Y-208T	1250		
C45	2.5D	2500	1982->1991	4	CRD93B		Y-208T	1250		
CX	2.5 TD	2500	1983->1986	4	M25 648		Y-208T	1250		
CX	2.5 D	2500	1982->1988	4	M25 660		Y-208T	1250		
CX	2.5 D PALLS,RD,TRD	2500	1982->1992	4	M25 660		Y-924J	3473		
CX	2.5 D REFLEX	2500	1979->1982	4	M25 629		Y-208T	1250		
CX	2.5 TD TURBO 2	2500	1987->1992	4	M25 669,671		Y-208T	1250		
DISPATCH	2.0D	2000	2000->	4	DW10		Y-504J	6246		
EVASION	1.9D	1900	1998->2002	4	XUD9TF, XUD9BTF		Y-924J	3473		
EVASION	2.0HDI	2000	1998->2002	4	DW10ATED		Y-504J	6246		

DAIHATSU										DAIHATSU
DELTA	3.0 D	3000	1947->1952	6	DV28		Y-178	7825		
DELTA TRUCK	2.5D	2500	1977->	4	DG		Y-128T	7227		
DELTA TRUCK	3.0D 12V	3000	1983->	4	B		Y-147T	7493		
DELTA TRUCK	3.0D 24V	3000	1977->1983	4	B		Y-178T	3030		
DELTA TRUCK	3.4D 12V	3400	1983->	4	3 B		Y-147T	7493		
DELTA TRUCK	3.4D 24V	3400	1980->1983	4	3 B		Y-178T	3030		
FOURTRAK	2.8D	2800	1984->1993	4	DL50		Y-146R	7492		
FOURTRAK	2.8D	2800	1989->1993	4	DL-T		Y-146R	7492		

FIAT										FIAT
242,15,18 D	2.5D	2500	1979->	4			Y-208T	1250		
BRAVA/BRAVO	2.0D	2000	1995->1996	4			Y-924J	3473		
DUCATO	2.8 JTD	2800	2006->	4	8140.435		Y-502R	3852		
PUNTO	1.7D	1700	1994->	4	176 A 3.000		Y-924J	3473		
PUNTO	1.7D S, SX, ELX TD	1700	1993->1996	4	176 TD, 1697 TT		Y-924J	3473		
ULYSSE	2.0JTD	2000	2002->	4	DW10ATED4, RHT		Y-504J	6246		
ULYSSE	2.1TD	2100	1996->	4	XUD11ATE		Y-924J	3473		

FORD										FORD
A-SERIES	3.6D YORK-D	3600		8	8AA		Y-208T	1250		
SCORPIO	2.5D	2500	1994->1998	4	SCD TCI		Y-741U	5065		
TRANSIT	2.4D YORK-D	2400	1983->1985	4	4AA		Y-208T	1250		

ISUZU										ISUZU
ELF 150	KAD 42	2400	1953->1954	4	C240		Y-154	7125		
FORWARD	FVR 9 TON	7800	2007->	6	6HK1		Y-784M1	90264		
FSR	FSR 550	3500	2010->	4			Y-784M1	90264		
HEAVY-DUTY	5.8D TY	5800		6	6BD1		Y-271-2	7467		
HEAVY-DUTY	6.4D TY	6400	1966->1979	6	DA640		Y-874-1	5326		
LIGHT BUS	3.9D BE	3900	1980->	4	4BD1		Y-271-2	7467		
LIGHT BUS	5.8D CCM	5800	1979->	6	6BD1		Y-271-2	7467		
LIGHT BUS	6.1D CCM	6100	1978->	6	6BF1		Y-271-2	7467		
MIDI	2.2D 11V	2200	1986->	4			Y-711J	5264		
N3000 P	2.5	2500		4			0,8 BPR6ES	96989		

IVECO										IVECO
DAILY	2.4D D30,35,40-8	2400	1978->1983	4	SOFIM 8140.61.200		Y-208T	1250		
DAILY	2.4D D30,35,40-8	2400	1983->1989	4	SOFIM 8140.61.200		Y-924J	3473		
DAILY	2.8 TDI	2800	1997->	4			Y-502R	3852		

KUBOTA										KUBOTA
TRACTOR	L SERIES						Y-106V	6926		
TRACTOR					B51,61,7		Y-103K	6325		



COMMERCIAL



COMMERCIAL VEHICLES



Model	Type	Capacity	Year	Cyl	Engine	Gap	Recommended	Stock Code	Alternative	Stock Code
-------	------	----------	------	-----	--------	-----	-------------	------------	-------------	------------

LEYLAND LEYLAND

400-SERIE	2.5 LTD DI	2500	1987->	5			Y-924J	3473		
-----------	------------	------	--------	---	--	--	--------	------	--	--

LEYLAND DAF LEYLAND DAF

SHERPA	2.0D	2000	1986->1988	4	PERKINS PRIMA ENGINE		Y-924J	3473		
SHERPA	2.5D	2500	1986->1989	4			Y-208T	1250		
SHERPA	2.5D	2500	1989->	4	PEUGEOT ENGINE		Y-924J	3473		

MAHINDRA MAHINDRA

CJ	340 CLASSIC D	2100	1993->	4	XD 4.90		Y-208T	1250		
CJ	340, 540 D	2100	1993->	4	XD 4.90		Y-924J	3473		
CJ	540 D	2100	1993->	4	XD 4.90		Y-208T	1250		

MAZDA MAZDA

E2000	2.0D	2000	1993->	4	RF		Y-107-R	1229		
LIGHT BUS PARKWAY	3.0D 12V	3000	1980->		HA		Y-107-R	1229		
T2500	2.5D 12V	2500	1980->		XA		Y-107-R	1229		
T3000	3.0D 12V	3000	1980->1992		HA		Y-107-R	1229		
T4100	4.1D 12V	4100	1980->		ZB		Y-107-R	1229		

MERCEDES BENZ MERCEDES BENZ

200 D,TD	W124	2000	1989->1993	4	OM 601.912		Y-916J	4454		
208 D		2300	1988->1995	4	OM 601.		Y-916J	4454		
210 D		2900	1988->	5	OM 602.		Y-916J	4454		
250 DT	W124	2500	1989->1993	5	OM 602.962		Y-916J	4454		
250 D,TD	W124	2500	1989->1993	5	OM 602.912		Y-916J	4454		
250 GD	W460	2500	1989->1993	5	OM 602.930		Y-916J	4454		
290 GD	W461	2900	1993->1994	6	OM 602.942, 947		Y-916J	4454		
290 GD	W461	2900	1997->	5	OM 602.983		Y-916J	4454		
300 D	W124	3000	1989->1993	6	OM 603.913		Y-916J	4454		
300 GD	W463	3000	1989->1993	6	OM 603.931		Y-916J	4454		
300 SD	W140	3000	1992->1993	6	OM 603.971		Y-916J	4454		
300 SED	W140	3000	1991->	6			Y-916J	4454		
300 TD	W124	3000	1989->1993	6	OM 603.960		Y-916J	4454		
300 TD	W124	3000	1989->1993	6	OM 603.960		Y-916J	4454		
300 TD	W124 4 MAT	3000	1989->1993	6	OM 603.963		Y-916J	4454		
350 D	W126	3500	1989->1991	6	OM 603.		Y-916J	4454		
350 D,TD	W126	3500	1990->1991	6	OM 603.970		Y-916J	4454		
350 GD	W463	3500	1991->1993	6	OM 603.972		Y-916J	4454		
508 D		2300	1989->	4	OM 601.		Y-916J	4454		
UNIMOG	100 L	2900	1992->	5	OM 602.948		Y-916J	4454		
UNIMOG	U 90 D	3000	1992->	5	OM 602.941		Y-916J	4454		

MITSUBISHI MITSUBISHI

1300	2.5D MINI BUS, VAN	2500		4	4D56		Y-115T-1	2189		
CANTER	2.6 LWB, SWB	2600	1983->	4	4G54	0,8	BPR6ES	96989		
CANTER	3.0 DT	3000	2001->2005	6	4M42		Y-1007J	8902		
CANTER			1978->	4	4D30		Y-274	2165		
EXPO	2.0 D LRV	2000	1993->1998	4	4D68		CZ257	96868		
L200	2.3 4X4	2300	1983->1986	4	4D55		Y-115T-1	2189		
L200	2.5 KOT-K3T	2500	1994->1996	4	4D56 SOHC		CZ257	96868		
L400	2.5 D	2500	1995->1997	4	4D56		CZ257	96868		
L400	2.5D	2500	1998->	4	4D56		Y-733J	8944		

NISSAN NISSAN

CABALL	2.0	2000		4	H20	0,8	BPR5ES	94084		
CABALL	3.0 12V	3000	1977->1980	4	ED30		Y-202-2	3226		
CABALL	3.0 12V	3000	1980->1981	4	ED30		Y-222T	7628		
CABALL	3.0 24V	3000	1981->	4	ED30		Y-272R-1	2731		
CABALL	3.0 D	3000	1955->1956	6	ED30		Y-222T	7628		
CABALL	3.3	3300	1980->1981	4	ED33		Y-272T	7328		
CABSTAR	2.2 12V	2200	1976->1977	4	SD22		Y-103	6125		
CABSTAR	2.2 12V	2200	1979->1982	4	SD22		Y-112T	6327		
CABSTAR	2.2 12V	2200	1977->1977	4	SD22		Y-103-1	6225		
CABSTAR	2.2 12V	2200	1977->1979	4	SD22		Y-103-2	2926		
CABSTAR	2.2 12V	2200	1982->	4	SD22		Y-112R-1	1032		
CABSTAR	2.3	2300		4	SD23		Y-112M-1	2531		
CABSTAR	2.3	2300		4	SD23		Y-112M-1	2531		
CABSTAR	2.3	2300		4	TD23		Y-707RS	4937		



Model	Type	Capacity	Year	Cyl	Engine	Gap	Recommended	Stock Code	Alternative	Stock Code
NISSAN										NISSAN
CABSTAR	2.3	2300		4	TD23		Y-707RS	4937		
CABSTAR	2.5	2500		4	SD25		Y-112M-1	2531		
CABSTAR	2.5	2500		4	TD25		Y-707RS	4937		
CABSTAR	2.5 F23, H41	2500		4	TD25		Y-707RS	4937		
CABSTAR	2.7	2700		4	TD27		Y-707RS	4937		
CABSTAR	2.7 F23, H41	2700		4	TD27		Y-707RS	4937		
CABSTAR	3.3	3300		4	ED33		Y-272R-1	2731		
CLIPPER	3.0 12V	3000	1980->1981	4	ED30		Y-222T	7628		
CLIPPER	3.0 24V	3000	1980->1981	4	ED30		Y-272T	7328		
CLIPPER	3.3 24V	3300	1980->1981	4	ED33		Y-272T	7328		
D21	2.5	2500	1993->	4	TD25		Y-707RS	4937		
D21	2.7	2700	1993->	4	TD27		Y-707RS	4937		
D21	2.7	2700	1993->	4	TD27T		Y-712RS	6140		
F22	2.7	2700		4	TD27		Y-707RS	4937		
F23	2.5	2500		4	TD25		Y-707RS	4937		
F23	2.7	2700		4	TD27		Y-707RS	4937		
FORKLIFT	1.5 12V	1500		3	SD15T NH02		Y-112R-1	1032		
FORKLIFT	2.2 12V	2200	1981->	4	SD22 QF01A, QF02A		Y-103-2	2926		
FORKLIFT	2.5	2500		4	SD25 CEF02, EF02, EGF02		Y-103-2	2926		
FORKLIFT	2.5 12V	2500		4	SD25 H01, H02		Y-112R-1	1032		
FORKLIFT	3.3	3300		6	SD33 FD005, FD006, FD007 SERIES 12V		Y-103	6125		
FORKLIFT			2010->		K25	0,8	FR2B-D	1598	FR2A-D	4768
H41	2.5	2500		4	TD25		Y-707RS	4937		
H41	2.7	2700		4	TD27		Y-707RS	4937		
INTERSTAR	2.5 DCI	2500	2006->	4	G9U362		Y-517J	3319		

OPEL										OPEL
BEDFORD	2.0 BLITZ D	2000	1978->1980	4		97000	Y-208T	1250		
BEDFORD	2.1 BLITZ D	2100	1975->1979	4	MOT.-NR. 21 DT-36242		Y-810	6929		

PEUGEOT										PEUGEOT
505	2.3D	2300	1981->	4	XD3(70-76CH)		Y-924J	3473		
505	2.3TD	2300	1980->1986	4	XD 2 S		Y-208T	1250		
505	2.5D	2500	1987->1993	4	XD 3		Y-924J	3473		
604	2.3TD	2300	1979->1981	4	XD 2 S		Y-208T	1250		
604	2.5TD	2500	1983->1986	4	XD 3 T		Y-924J	3473		
605	2.1TD	2100	1998->2000	4	XUD11ATE,BTE		Y-924J	3473		
605	2.5TD	2500	1994->1999	4	DK5 ATE		Y-924J	3473		
BOXER	1.9D	1900	1998->	4	XUD9AU		Y-924J	3473		
BOXER	1.9TD	1900	1994->1998	4	XUD9TF		Y-924J	3473		
BOXER	2.2 HDI	2200	2001->	4	DW10TED4		Y-504J	6246		
BOXER	2.5D	2500	1994->1998	4	DJ5		Y-924J	3473		
BOXER	2.8HDI	2800	1997->	4	SOFIM		Y-924J	3473		
EXPERT	1.8TD	1800	1998->	4	DW8TD		Y-503J	5005		
EXPERT	1.9D	1900	1996->1998	4	XUD9BTF		Y-924J	3473		
EXPERT	1.9D	1900	1996->1998	4	XUD9TF		Y-924J	3473		
EXPERT	1.9TD	1900	1998->	4	XUD9BTF		Y-924J	3473		
EXPERT	2.0 HDI	2000	2000->	4	DW10ATED		Y-504J	6246		
EXPERT	2.1D	2100	1996->	4	XUD11ATE		Y-924J	3473		
J	1.9 5D	1900	1987->	4	XUD9A		Y-924J	3473		
J	2.5 5TD	2500	1987->1991	4	CRD93LS		Y-208T	1250		
J5	1.9D	1900	1987->1994	4	XUD9A		Y-924J	3473		
J5	2.5D	2500	1991->1994	4	CRD93LS		Y-924J	3473		
J7	2.1D	2100	1970->1978	4	XDP90		Y-810	6929		
J7	2.3D	2300	1979->1980	4	XD2P94		Y-208T	1250		
J9	2.1D	2100	1980->1982	4	XDP4.90 (56CH)		Y-208T	1250		
J9	2.1D	2100	1982->	4	XDP4.90 (56CH)		Y-924J	3473		
J9	2.3D TRANSPORTER	2300	1980->1982	4	XD2P		Y-208T	1250		
J9	2.5D	2500	1982->	4	XD3P (72CH)		Y-924J	3473		
J9	2.5D TRANSPORTER	2500	1980->1982	4	XD3P		Y-208T	1250		

RENAULT										RENAULT
B70	2.5TD	2500	1983->1990				Y-924J	3473		
R18	2.1D	2100	1984->1986	4	J8S		Y-924J	3473		
R18	2.1TD	2100	1984->1986	4	J8S (68CH)		Y-924J	3473		
R19	1.9TD	1900	1990->1996	4	F8Q610,740,744,768		Y-933J	6599		
R21	1.9D NEVADA	1900	1991->1995	4	F8Q710		Y-924J	3473		
R21	2.1D NEVADA	2100	1989->1993	4	J8S...		Y-924J	3473		
R25	2.1TD	2100	1984->1992	4	J8S-708,738		Y-924J	3473		
TRAFIC	2.1D P1000, P1200, 4X4	2100	1981->1997	4	852,720,750		Y-924J	3473		



COMMERCIAL



COMMERCIAL VEHICLES

Model	Type	Capacity	Year	Cyl	Engine	Gap	Recommended	Stock Code	Alternative	Stock Code
-------	------	----------	------	-----	--------	-----	-------------	------------	-------------	------------

RENAULT										RENAULT
VEL SATIS	2.2DCI	2200	2002->2003	4	G9T702		Y-517J	3319		
WINNEBAGO	2.1D	2100	1982->1987	4	J8S 232, J8S 234		Y-924J	3473		

TOYOTA										TOYOTA
--------	--	--	--	--	--	--	--	--	--	--------

2R,3R,F,2F	FORKLIFT						0,8 BPR5EY	94270		
4P,5R	FORKLIFT						0,8 BPR2ES	2264		
4RUNNER	2.4D 12V	2400		4	2L		Y-118-R	2187		
4RUNNER	2.4TD	2400	1990->1996	4	2L-T		Y-715R	5376		
4RUNNER	2.5D	2500	1993->	4	2L-T		Y-715R	5376		
4RUNNER	2.8D	2800	1993->	4	3L		Y-715R	5376		
4RUNNER	3.0D KZN185	3000	1993->	4	1KZ-T		Y-715R	5376		
5P	FORKLIFT						0,8 BPR4ES	7222	GR4IX	7149
COASTER	12V		1993->		13B		Y-147T	7493		
COASTER	4.0D 24V	4000	1982->	6	2H		Y-197-R	2188		
CROWN	2.5D	2500	1993->	4	2L		Y-715R	5376		
DYNA	2500 12V	2400		4	2L		Y-118-R	2187		
DYNA	2500 12V	2500	1993->	4	2L		Y-715R	5376		
DYNA	2800	2800	1993->	4	3L		Y-715R	5376		
DYNA	2.5D	2500	2000->	4	2KD-FTV		Y-531J	2979		
DYNA	3000		1980->1982	4	3B		Y-178T	3030		
DYNA	3000 12V	3000	1993->	4	B 11B		Y-147T	7493		
DYNA	3000 12V	3000	1974->1980	4	B		Y-128T	7227		
DYNA	3000 12V	3000	1977->1980		2B		Y-128T	7227		
DYNA	3000 24V	3000	1982->1989	4	B		Y-197-R	2188		
DYNA	3000 24V	3000	1990->1991	4	B		Y-178T	3030		
DYNA	3000 24V		1977->1980		2B		Y-178T	3030		
DYNA	3700 12V		1993->		14B		Y-147T	7493		
DYNA	3700 24V		1974->1982	6	H, 2H		Y-178T	3030		
DYNA	3700 24V		1982->	6	H, 2H		Y-197-R	2188		
DYNA	3.7 D	3700	1969->1975	6	2J		Y-402-2	4926		
HINO	BUS		1968->		EB200		Y-176	7625		
HINO	BUS		1968->		EB300		Y-176	7625		
HINO	BUS		1968->		EB400		Y-176	7625		
HINO	BUS		1968->		EH100		Y-176	7625		
HINO	BUS		1968->		EH300		Y-176	7625		
HINO	BUS		1968->1976		DM100		Y-176	7625		
HINO	BUS		1968->1979		EC100		Y-176	7625		
HINO	RANGER	2500	1978->	4	DG		Y-128T	7227		
HINO	RANGER	3000	1983->1988	4	B, D		Y-197-R	2188		
HINO	RANGER	3400	1983->1988	4	3 B, D		Y-197-R	2188		
HINO	RANGER		1968->		EH300		Y-176	7625		
TRUCK	2.4D 24V	2400	1973->	4	2L		Y-118-R	2187		

VOLKSWAGEN										VOLKSWAGEN
------------	--	--	--	--	--	--	--	--	--	------------

LT	2.4TD	2400	1978->1982	6	CP		Y-918J	3704		
LT	2.5TD	2500	1995->1996	5	ACV		Y-732J	5909		
LT 28	2.8TDI	2800	1996->	6	AHD		Y-732J	5909		
LT 31	2.4D	2400	1988->1995	6	1S		Y-918J	3704		
LT 35	2.5SDI	2500	1996->2001	5	AGX		Y-732J	5909		
LT 35	2.8TDI	2800	1996->	5	AHD		Y-732J	5909		
PHAETON	5.0TDI	5000	2002->	10	AJS		Y-741U	5065		

VOLVO										VOLVO
-------	--	--	--	--	--	--	--	--	--	-------

200			1981->				Y-207T	1239		
240	2.0D	2000	1979->1981	4	D 20		Y-918J	3704		
240	2.4D	2400	1979->1993	4	D 24		Y-918J	3704		
340			1984->				Y-918J	3704		
440	1.9TD	1900	1993->	4	RENAULT F8Q		Y-933J	6599		
460	1.9TD	1900	1994->	4	D 19 T		Y-933J	6599		
740	2.4TD	2400	1987->1992	6	D 24 TIC		Y-918J	3704		
760	2.4TD	2400	1987->1992	6	D 24 TIC		Y-918J	3704		
780	2.4TD	2400	1985->	6	D 24 TIC		Y-918J	3704		
850	2.5TDI	2500		5	AUDI D5252		Y-732J	5909		



Model	Type	Capacity	Year	Cyl	Engine	Gap	Recommended	Stock Code	Alternative	Stock Code
ARCTIC CAT										
50	50 ATV	50	2006->	1		0,8	CR7HSA	4549	ARCTIC CAT	
90	90 ATV	90	2006->	1		0,8	CR7HSA	4549		
250	250 ATV	250	1999->2005	1		0,7	DR7EA	7839		
300	300 ATV	300	1998->2005	1		0,7	DR7EA	7839		
400	400 ATV	400	2004->2006	1		0,8	CR7E	4578		
500	500 ATV	500	1999->2006	1		0,8	CR6E	6965		
650	650 ATV	650	2004->2006	1		0,8	CR7E	4578		
650	650 ATV	650	2006->	1		0,8	CPR8EA-9	2306		
BASHAN										
150	CVT 150	150	2011->	1		0,8	C7HSA	4629	CR7HSA	4549
250	CHEETAH SPORT 200	250	2011->	1		0,8	D8EA	2120	DR8EA	7162
250	GRIZZLEY CVT 250	250	2011->	1		0,8	D8EA	2120	DR8EA	7162
BIG BOY										
110	CR 110 MONSTER	110	2011->	1		0,8	C7HSA	4629	CR7HSA	4549
110	JNR 110 R6 MONSTER	110	2011->	1		0,8	C7HSA	4629	CR7HSA	4549
110	JNR 110 R7 MONSTER	110	2011->	1		0,8	C7HSA	4629	CR7HSA	4549
125	CR 125 MONSTER	125	2011->	1		0,8	C7HSA	4629	CR7HSA	4549
300	D300	300	2011->	1		0,8	D8EA	2120	DR8EA	7162
300	H300	300	2011->	1		0,8	DR8EA	7162		
450	SBS450	450	2011->	1		1,1	IFR8H-11	5068	BKR8E-11	6587
550	K550 MONSTER FI	550	2011->	1		0,8	DR8EA	7162		
BOMBARDIER										
250	DS250	250	2006->	1		0,8	CR8E	1275		
330	OUTLANDER 330	330	2002->	1		0,8	DCPR8E	4339		
400	OUTLANDER 400	400	2003->	1		0,8	DCPR8E	4339		
450	DS 450	450	2008->	1		0,8	DCPR9E	2641		
500	OUTLANDER 500	500	2007->	1		0,8	DCPR8E	4339		
500	RENEGADE 500	500	2008->	1		0,8	DCPR8E	4339		
650	DS 650	650	2000->2007	1		0,8	DCPR8E	4339		
650	OUTLANDER 650	650	2006->	1		0,8	DCPR8E	4339		
800	OUTLANDER 800	800	2006->	2		0,8	DCPR8E	4339		
CAGIVA										
125	RAPTOR	125	2004->	1		0,8	BR9EG	3230	BR9ES	5722
650	RAPTOR	650	2000->	2		0,8	CR8E	1275		
GAS GAS										
300	HP 300 WILD ATV	300	2003->	1		0,8	BR8EIX	5044	BR8ES	5422
GOMOTO										
70	PUMA 70 CVT	70	2011->	1		0,8	C7HSA	4629	CR7HSA	4549
110	ORION 110	110	2011->	1		0,8	C7HSA	4629	CR7HSA	4549
150	CVT 150	150	2011->	1		0,8	C7HSA	4629	CR7HSA	4549
250	250 WATER COOLED	250	2011->	1		0,8	D8EA	2120	DR8EA	7162
HONDA										
90	TRX 90 ATV	90	1993->2006	1		0,8	CR7HSA	4549	CR7HIX	7544
200	ATC BIG RED	200	1982->1983	1		0,7	D8EA	2120	DR8EA	7162
200	ATC200,E,ES,M,S,X	200	1982->1984	1		0,7	D8EA	2120	DR8EA	7162
200	TRX-200,XN SPORT,DN AGRI	200	1981->1985	1		0,7	D8EA	2120	DR8EA	7162
200	TRX200DV	200	1991->1998	1		0,7	DR8ESL	2923		
250	ATC250ES,SX	250	1985->	1		0,7	D8EA	2120	DR8EA	7162
250	ATC250R	250	1985->1987	1		0,8	B8ES	2411	BR8ES	5422
250	ATC250R ATV	250	1984->1986	1		0,8	BR9ES	5722		
250	ATC250SX	250	1985->	1		0,7	D8EA	2120	DR8EA	7162
250	TRX250EX ATV	250	2001->2006	1		0,9	DPR8EA-9	4929		
250	TRX250R ATV	250	1987->1988	1		0,8	BR9ES	5722		
250	TRX250TM ATV	250	1996->2006	1		0,9	DPR8EA-9	4929		
250	TRX250X ATV	250	1985->1987	1		0,7	DR8ESL	2923		
300	TRX300 FWP4X4	300	2000->2006	1		0,9	DPR8EA-9	4929		
300	TRX300EX ATV	300	1993->2005	1		0,7	DR8ESL	2923		
300	TRX300EX ATV	300	2006->	1		0,7	DR7EA	7839		



ATV



Model	Type	Capacity	Year	Cyl	Engine	Gap	Recommended	Stock Code	Alternative	Stock Code
HONDA										
300	TRX300FWT	300	2000->2006	1		0,9	DPR8EA-9	4929		
350	TRX350TE	350	2000->2006	1		0,9	DPR7EA-9	5129		
400	400FGA ATV	400	2004->2006	1		0,9	DPR7EA-9	5129		
400	TRX400EX ATV	400	2001->2006	1		0,8	DPR8Z	4730		
400	TRX400FE ATV	400	2004->2006	1		0,9	DPR7EA-9	5129		
400	TRX400FGA ATV	400	2004->2007	1		0,9	DPR8EA-9	4929		
400	TRX400FWT	400	1995->2004	1		0,9	DPR7EA-9	5129		
450	TRX 450 R/ ER	450	2006->2009	1		1,1	IFR7L-11	5114		
450	TRX450	450	1998->	1		0,9	DPR7EA-9	5129		
450	TRX450ER ATV	450	2006->	1		1,1	IFR8H-11	5068	BKR8E-11	6587
450	TRX450R ATV	450	2004->2006	1		1,1	IFR8H-11	5068	BKR8E-11	6587
450	TRX450R,ER ATV	450	2004->2006	1		1,1	IFR8H-11	5068	BKR8E-11	6587
450	TRX450V ATV	450	1998->	1		0,9	DPR7EA-9	5129		
500	4 WHEELER ATV	500	2001->	1		0,9	LJR7A-9	7901	DPR7EA-9	5129
500	TRX500 ATV	500	2001->	1		0,9	LJR7A-9	7901	DPR7EA-9	5129
500	TRX500FA	500	2001->	1		0,9	LJR7A-9	7901	DPR7EA-9	5129
500	TRX500FA ATV	500	2001->2006	1		0,9	LJR7A-9	7901	DPR7EA-9	5129
500	TRX500FE ATV	500	2005->2006	1		1,1	BKR5ES-11	91130		
500	TRX500FE ATV	500	2005->2006	1		1,1	BKR5ES-11	91130		
500	TRX500FE,FM,TM	500	2005->2009	1		1,1	BKR5ES-11	91130		
500	TRX500FGA ATV	500	2004->2006	1		0,9	LJR7A-9	7901	DPR7EA-9	5129
650	TRX650FA ATV	650	2005->	1		1	IFR5N-10	7866	BKR5E-11	93674
650	TRX650FGA ATV	650	2005->	1		1,1	IFR5N-10	7866	BKR5E-11	93674
680	TRX680FA	680	2006->	1		1	IFR5N-10	7866	BKR5E-11	93674

KAWASAKI										
50	KFX50 ATV	50	2004->2006	1		0,7	BPR4HS	7823		
50	KFX50A ATV	50	2003->	1		0,7	BPR4HS	7823		
80	KFX80 ATV	80	2003->2006	1		1	BPR7HIX	5944		
160	KLT160	160	1985->	1		0,7	C6HSA	3228	CR6HSA	2983
185	KLF185	185	1985->1988	1		0,7	D8EA	2120	DR8EA	7162
185	KLF185 BAYOU	185	1985->1988	1		0,7	D8EA	2120	DR8EA	7162
200	KLT200	200	1981->1984	1		0,8	B7ES	1111	BR7ES	5122
250	KLF250 ATV	250	2003->2010	1		0,7	DR8EA	7162		
250	KLF250A ATV	250	2002->2010	1		0,7	DR8EA	7162		
300	KLF300 BAYOU,PRAIRIE 4X4	300	2000->	1		0,7	DR8EA	7162		
300	KVF300 CEF	300	2014->	1		0,9	DPR7EA-9	5129		
360	KVF360 ATV	360	2003->2006	1		0,9	DPR8EA-9	4929		
400	KAF400 BEF	400	2014->	2		0,9	BPR5ES	94084		
400	KFX400 ATV	400	2003->2006	1		0,8	CR7E	4578		
400	KFX400A ATV	400	2003->	1		0,8	CR8E	1275		
400	KLF400	400	1993->1999	1		0,9	DPR8EA-9	4929		
400	KSF400 F ATV	400	2003->2006	1		0,8	CR7E	4578		
450	KSF450 BEF	450	2014->	1		0,9	CPR8EB-9	6607		
650	KVF650 ATV	650	2005->	2		0,8	CR7E	4578		
650	KVF650 FEF	650		1		0,8	CR7E	4578		
700	KFX700 ATV	700	2004->2006	2		0,8	CR7E	4578		
700	KSV700A ATV	700	2004->2006	2		0,8	CR7E	4578		
700	KSV700B ATV	700	2004->2006	2		0,8	CR7E	4578		
700	KSV700C ATV	700	2006->	2		0,8	CR7E	4578		
750	KSV750 ATV	750	2004->2006	2		0,8	CR7E	4578		
750	KVF750 ATV	750	2005->	2		0,8	CR7E	4578		

KYMCO										
50	MX ATV	50	2001->	1		0,8	BR8HS	4322		
50	MXER ATV	50	2002->2005	1		0,8	BR8HS	4322		
90	MONGOOSE ATV	90	2004->2005	1		0,8	CR7HSA	4549		
150	ATV	150	2002->2005	1		0,8	CR8E	1275		
150	MX ATV	150	2001->	1		0,7	DR8EA	7162		
250	KXR ATV	250	2001->	1		0,9	DPR7EA-9	5129		
250	MONGOOSE ATV	250	2004->2005	1		0,9	DPR7EA-9	5129		
250	MXU ATV	250	2005->	1		0,9	DPR7EA-9	5129		
250	VENOX 4 TAKT	250	2001->	1		0,9	DPR7EA-9	5129		

LEM										
50	CAYMAN ATV	50	1997->2004	1		0,8	BR8HS	4322		
50	CONDOR ATV	50	1997->2004	1		0,8	BR8HS	4322		



ATV



Model	Type	Capacity	Year	Cyl	Engine	Gap	Recommended	Stock Code	Alternative	Stock Code
-------	------	----------	------	-----	--------	-----	-------------	------------	-------------	------------

POLARIS										POLARIS
POLARIS										POLARIS
200	PHOENIX ATV	200	2005->	1		0,8	CR7HSA	4549		
250	R TRAILER BLAZER 2X4	250	1990->1995	1		0,8	BR8ES	5422		
250	TRAIL BLAZER ATV	250	1990->	1		0,8	BR8ES	5422		
300	HAWKEYE ATV	300	2006->	1		0,8	CR8E	1275		
325	M/NUM 4X4	325	1995->	1		0,8	BKR6E	97737		
325	R M/NUM 2X4	325	2000->	1		0,8	BKR6E	97737		
325	T/BOSS 2X4	325	1995->	1		0,8	BKR6E	97737		
330	MAGNUM ATV	330	2005->	1		0,8	BKR6EY	91756		
335	SPORTSMAN 4X4	335	2005->	1		0,8	BCPR7E	1272		
400	SCRAM 2X4,4X4	400	1993->1994	1		0,8	BR8ES	5422		
400	SPORTSMAN ATV	400	2003->2005	1		0,8	BKR5ES	90841		
400	XPLOER	400	1994->	1		0,8	BR8ES	5422		
425	XPEDITION	425	1995->	1		0,8	BKR5E	92870		
450	SPORTSMAN ATV	450	2006->	1		0,8	BKR6E	97737		
500	PREDATOR ATV	500	2005->	1		0,8	DCPR8E	4339		
500	R M/NUM 4X4	500	1995->	1		0,8	BKR5E	92870		
500	R SCRAM 4X4	500	1992->1994	1		0,8	BKR5E	92870		
500	RANGER 6X6	500	1998->	1		0,8	BKR5E	92870		
500	RANGER ATV	500	2004->2006	1		0,8	BKR6E	97737		
500	SCRAM 2X4	500	1998->	1		0,8	BKR5E	92870		
500	SPORTSMAN 6X6	500	2005->	1		0,8	BKR6E	97737		
500	SPORTSMAN 4X4	500	1996->2004	1		0,8	BKR5E	92870		
570	570	570	2014->	1		0,8	MR7F	95897		
600	SPORTSMAN ATV	600	2003->2005	1		0,8	BCPR7E	1272		
700	SPORTSMAN ATV	700	2003->	1		0,8	BCPR7E	1272		
800	SPORTSMAN	800	2005->	1		0,8	BCPR7E	1272		
850	850	850	2009->2010	2		0,8	LZKAR7A	6799		

SUZUKI										SUZUKI
50	LT-A50 K2	50	2001->	1		0,7	BPR4HS	7823		
50	LT50	50	2002->	1		0,7	BP4HS	3611	BPR4HS	7823
50	LT50E,L	50	1998->	1		0,7	BP4HS	3611	BPR4HS	7823
80	LT-80 ATV	80	1996->2005	1		1	BPR7HS-10	1092		
80	LT80,M,N	80	1987->1995	1		0,7	BP7HS	5111		
160	LTF160L ATV	160	1998->2001	1		0,9			DPR7EA-9	5129
185	LT185	185	1986->	1		0,7	D7EA	7912	DR7EA	7839
185	LT185E,FE	185	1984->1987	1		0,7	D7EA	7912	DR7EA	7839
230	LT-F230	230	1987->	1		0,7	D7EA	7912	DR7EA	7839
230	LT230GE	230	1979->1983	1		0,7	D7EA	7912	DR7EA	7839
230	LT230GEF	230	1991->1993	1		0,7	D7EA	7912	DR7EA	7839
230	LT230GE,GF,SF	230	1989->1991	1		0,7	D7EA	7912	DR7EA	7839
230	LT230S	230	1985->1993	1		0,7	D7EA	7912	DR7EA	7839
250	LT-F 250 ATV	250	1999->2005	1		0,7	DR7EA	7839		
250	LT-Z 250 ATV	250	2005->2005	1		0,7	DR7EA	7839		
250	LT250EFF	250	1986->	1		0,7	D8EA	2120	DR8EA	7162
250	LT250RF	250	1985->	1		0,8	B8ES	2411	BR8ES	5422
250	LTF250K	250	2002->2009	1		0,7	D7EA	7912	DR7EA	7839
300	LTF 300	300	1999->	1		0,7	D8EA	2120	DR8EA	7162
400	LT-A400F ATV	400	2002->2005	1		0,8	CR7E	4578		
400	LT-Z 400 ATV	400	2003->2005	1		0,8	CR8E	1275		
400	LTF-400F ATV	400	2002->2005	1		0,8	CR7E	4578		
400	LTZ400	400	2002->2003	1		0,8	CR7E	4578		
400	LTZ400 ATV	400	2002->	1		0,8	CR8E	1275		
450	LTR450 ATV	450	2007->	1		0,8	CR8E	1275		
500	LT-F 500F ATV	500	2004->2005	1		0,8	CR7E	4578		
500	LTA500F ATV	500	2007->	1		0,8	CR6E	6965		
500	LTF500 ATV	500	2007->	1		0,8	CR6E	6965		
700	LT-A700X ATV	700	2005->	1		0,9	CR6EIA-9		CR6E	6965
700	LT-V700F ATV	700	2005->	1		0,9	CR6EIA-9		CR6E	6965

SYM										SYM
250	QUADLANDER ATV	250	2006->	1		0,8	BPR8HIX	6742	BPR8HS	3725

YAMAHA										YAMAHA
80	YFM 80 GRIZZLY	80	2005->2012	1		0,8	CR7HSA	4549		
80	YFM80E	80	1993->	1		0,7	C7HSA	4629	CR7HSA	4549
80	YFM80N	80	1985->2001	1		0,7	C7HSA	4629	CR7HSA	4549
125	YFA1	125	1999->2004	1		0,8	CR7HSA	4549		

- DIESEL VEHICLE |



ATV



Model	Type	Capacity	Year	Cyl	Engine	Gap	Recommended	Stock Code	Alternative	Stock Code
YAMAHA										
125	YFM 125 ATV	125	2005->2006	1		0,8	CR7HSA	4549		
200	YFS 200 ATV	200	2001->2006	1		0,8	BR8ES	5422		
200	YFS200 ATV	200	1990->2004	1		0,8	B8ES	2411	BR8ES	5422
250	YFB250	250	1999->2000	1		0,7	DR7EA	7839		
250	YFB250E	250	1992->1998	1		0,7	D7EA	7912	DR7EA	7839
250	YFM250 ATV	250	2005->	1		0,7	DR7EA	7839		
350	YFM 350 ATV	350	2004->2012	2		0,7	DR8EA	7162		
350	YFM350ERT	350	1994->	2		0,7	D8EA	2120	DR8EA	7162
350	YFP350	350	1988->	1		0,7	D8HS	7012		
350	YFZ350 BANSHEE	350	1987->2006	2		0,8	BR8ES	5422		
400	YFM 400F ATV	400	2000->2006	1		0,7	DR8EA	7162		
400	YFM400	400	2000->	1		0,7	DR8EA	7162		
400	YFM400 AN ATV	400	2003->2004	1		0,7	DR8EA	7162		
400	YFM400 FW ATV	400	1994->2004	1		0,7	DR8EA	7162		
400	YFM450 AN	400	2003->2004	1		0,7	DR8EA	7162		
400	YP400 ATV	400	2005->	1		0,8	CR7E	4578		
450	YFM 450F ATV	450	2003->2006	1		0,7	DR8EA	7162		
450	YFZ450S ATV	450	2004->	1		0,8	CR8E	1275		
450	YZF 450V ATV	450	2006->	1		0,8	CR8E	1275		
550	YFM550 GRIZZLY	550	2010->	2		0,9	LMAR6A-9	5946		
600	YFM600 GRIZZLY	600	1999->2005	2		0,9	DPR8EA-9	4929		
660	YFM 660 GRIZZLY ATV	660	2002->2004	1		0,9	DPR8EA-9	4929		
660	YFM660R RAPTOR	660	2001->	1		0,9	DPR8EA-9	4929		
700	YFM 700RV ATV	700	2006->	1		0,8	CR8E	1275		
700	YFM700 RAPTOR ATV	700	2007->	1		0,8	CR8E	1275		
700	YFM700F GRIZZLY	700	2009->	1		0,9	LMAR6A-9	5946		

ATV / QUAD



GOLF CART



Model	Type	Capacity	Year	Cyl	Engine	Gap	Recommended	Stock Code	Alternative	Stock Code
CLUB CAR										
CAFE EXPRESS	351		2003>			0,8	BPR5ES	94084		
CARRY ALL 272	351		2000>2003			0,8	BPR5ES	94084		
CARRY ALL TURF 1,2	286		1992>2003			0,8	BPR5ES	94084		
CARRY ALL TURF 2 XRT	351		2003>			0,8	BPR5ES	94084		
VILLAGER SERIES	351		2003>			0,8	BPR5ES	94084		
EZGO										
	GOLFCART					0,8	FR2B-D	1598	FR-A-D	
YAMAHA										
G-MAX	357		2003>			0,8	BPR2ES	2264		
U-MAX UTILITY	357		2003>			0,8	BPR2ES	2264		

GOLF CART



MOTOR CYCLES



Model	Type	Capacity	Year	Cyl	Engine	Gap	Recommended	Stock Code	Alternative	Stock Code
-------	------	----------	------	-----	--------	-----	-------------	------------	-------------	------------

APACHE

APACHE

TVR	180	180	2012->	1		0,8	CR9EIX	3521	CR9E	6263
-----	-----	-----	--------	---	--	-----	--------	------	------	------

APRILIA

APRILIA

50	RS4	50	2011->	1		0,8	BR8ES	5422		
125	MOJITO 125	125	2005->	1		0,8	CR9E	6263		
125	MX 125	125	2004->	1		0,8	BR8EIX	5044	BR8ES	5422
125	RS 125	125	1996->2005	1		0,8	BR8ES	5422		
125	RS125	125	2006->2007	1		0,8	BR10EG	3830		
125	RS4	125	2011->	1		0,8	CR9EB	6955		
250	RS 250	250	1995->2003	2		0,8	BR9ECM	3252		
400	SCARABEO 400	400	2007->	1		0,8	CR7EKC	7004		
450	ENDOMOTO 450	450	2007->	2		0,8	CR8EK	3478		
450	RXV 450	450	2006->	2		0,8	CR8E	1275		
450	SXV 450	450	2007->	2		0,8	CR8EK	3478		
550	RXV 550	550	2007->	2		0,8	CR8EK	3478		
650	PEGASO 650	650	2001->2005	1		0,6	DR8EB	4855	DR8EA	7162
650	PEGASO 650	650	2007->	1		0,8	CR7E	4578		
650	PEGASO ML,MX,GA 650	650	1997->	1		0,7	DR8EA	7162		
650	PEGASO TRIAL 650	650	2006->	1		0,8	CR7E	4578		
660	PEGASO 660	660	2006->2009	1		0,8	CR7E	4578		
750	DORSODURO 750	750	2010->	2		0,8	CR7EKC	7004		
750	SHIVER 750	750	2007->	2		0,8	CR7EKC	7004		
750	SHIVER GT 750	750	2009->	2		0,8	CR7EKC	7004		
850	MANA GT 850	850	2009->	2		0,8	CR7EKC	7004		
1000	ETV 1000	1000	2001->2004	2		0,8	DCPR9E	2641		
1000	FALCO 1000 SL	1000	2000->	2		0,7	DCPR9EIX	2316	DCPR9E	2641
1000	RSV 1000 SP	1000	2000->2003	2		0,8	R0045Q-10	4216		
1000	RSV 1000 SPRC	1000	2010->	4		0,8	CR9EB	6955		
1000	RSV 1000R MILE	1000	1998->	2		0,7	DCPR9EIX	2316	DCPR9E	2641
1000	RSV4 1000	1000	2007->	2		0,8	DCPR9E	2641		
1000	RSV4 1000 R	1000	2009->2011	2		0,8	CR9EB	6955		
1000	TUONO 1000	1000	2004->2006	2		0,8	DCPR9E	2641		
1000	TUONO 1000 V4	1000	2011->	4		0,8	CR9EK	4548		
1200	1200 CAPONORD	1200	2013->	2		0,8	CR8EKB	4374	CR8EK	3478
1200	DORSODURO 1200	1200	2010->	2		0,8	CR9EK	4548		

BAJAJ

BAJAJ

100	100 BOXER BM	100	2011->	1		0,8	C7HSA	4629	CR7HSA	4549
125	125 PLATINA	125	2011->	1		0,8	C7HSA	4629	CR7HSA	4549
135	135 PULSAR LS	135	2011->	1		0,8	CR9E	6263		
180	180 PULSAR DTS-I	180	2011->	1		0,8	CR9E	6263		
180	180 PULSAR UG4	180	2011->	1		0,8	CR9E	6263		
220	220 AVENGER	220	2011->	1		0,8	CR9E	6263		
220	220 PULSAR	220	2011->	1		0,8	CR9E	6263		
220	220 RE-4S	220	2011->	1		0,8	D8EA	2120	DR8EA	7162

BASHAN

BASHAN

100	100 BS-R	100	2011->	1		0,8	C7HSA	4629	CR7HSA	4549
125	125 PITT	125	2011->	1		0,8	C7HSA	4629	CR7HSA	4549
125	125 R	125	2011->	1		0,8	C7HSA	4629	CR7HSA	4549
125	125 RR	125	2011->	1		0,8	C7HSA	4629	CR7HSA	4549
125	125 X-PL0DE	125	2011->	1		0,8	C7HSA	4629	CR7HSA	4549
125	125 X-PL0DE SCRAMBLER	125	2011->	1		0,8	C7HSA	4629	CR7HSA	4549
125	125 X-PL0DE MOTARD	125	2011->	1		0,8	C7HSA	4629	CR7HSA	4549
150	150 RR	150	2011->	1		0,8	C7HSA	4629	CR7HSA	4549
200	200 X-PL0DE SCRAMBLER	200	2011->	1		0,8	D8EA	2120	DR8EA	7162
250	250 HAWK XTC	250	2011->	1		0,8	D8EA	2120	DR8EA	7162
250	250 R	250	2011->	1		0,8	D8EA	2120	DR8EA	7162
250	250 RR	250	2011->	1		0,8	D8EA	2120	DR8EA	7162
250	250 X-PL0DE	250	2011->	1		0,8	D8EA	2120	DR8EA	7162

BENELLI

BENELLI

899	TORNADO NAKED TRE	900	2010->	3		0,8	CR9E	6263		
1130	CENTURY RACER	1130	2010->	3		0,8	CR9E	6263		
1130	TORNADO NAKED TRE	1130	2006->	3		0,8	CR9E	6263		
1130	TRE 1130K	1130	2007->	3		0,8	CR9E	6263		



MOTOR CYCLES



Model	Type	Capacity	Year	Cyl	Engine	Gap	Recommended	Stock Code	Alternative	Stock Code
BETA										
250	RR 250 2T	250	2012->	1		0,8	BR8ES	5422		BETA
300	RR 300 2T	300	2012->	1		0,8	BPR7EIX	4055		
300	X TRAINER	300	2013->	1		0,8	BPR7EIX	4055		
400	RR 400 4T	400	2010->	1		0,9	LKAR8AI-9	6706	LKAR8A-9	4786
450	RR 450 4T	450	2010->	1		0,9	LKAR8AI-9	6706	LKAR8A-9	4786
498	RR 498 4T	498	2013->	1		0,9	LKAR8AI-9	6706	LKAR8A-9	4786

BIG BOY										
50	50 JNR ZOOKA	50	2011->	1		0,8	BP5HS	4111		
100	100 JNR ZOOKA	100	2011->	1		0,8	C7HSA	4629	CR7HSA	4549
125	125 TTR ZOOKA	125	2011->	1		0,8	C7HSA	4629	CR7HSA	4549
125	125 VENTURE	125	2011->	1		0,8	C7HSA	4629	CR7HSA	4549
125	CGL 125	125	2011->	1		0,8	D8EA	2120	DR8EA	7162
125	CR125 ZOOKA	125	2011->	1		0,8	C7HSA	4629	CR7HSA	4549
125	CRF125-801 ZOOKA	125	2011->	1		0,8	C7HSA	4629	CR7HSA	4549
125	CRF125 ZOOKA	125	2011->	1		0,8	C7HSA	4629	CR7HSA	4549
125	GP 125 CB	125	2011->	1		0,8	D8EA	2120	DR8EA	7162
125	GP 125 NCB	125	2011->	1		0,8	D8EA	2120	DR8EA	7162
125	XTG 125	125	2011->	1		0,8	D8EA	2120	DR8EA	7162
150	CGL 150	150	2011->	1		0,8	D8EA	2120	DR8EA	7162
150	CR150 ZOOKA	150	2011->	1		0,8	C7HSA	4629	CR7HSA	4549
150	LEGACY 150	150	2011->	1		0,8	C7HSA	4629	CR7HSA	4549
150	SUPERLIGHT 150	150	2011->	1		0,8	C7HSA	4629	CR7HSA	4549
160	CRF160-801 ZOOKA	160	2011->	1		0,8	C7HSA	4629	CR7HSA	4549
160	TTR160 ZOOKA	160	2011->	1		0,8	C7HSA	4629	CR7HSA	4549
200	GP 200 CB	200	2011->	1		0,8	D8EA	2120	DR8EA	7162
200	GP 200 NCB	200	2011->	1		0,8	D8EA	2120	DR8EA	7162
200	XTG 200	200	2011->	1		0,8	D8EA	2120	DR8EA	7162
250	BLACKBALL 250	250	2011->	1		0,8	C7HSA	4629	CR7HSA	4549
250	CRUISER 250	250	2011->	1		0,8	C7HSA	4629	CR7HSA	4549
250	SRC 250	250	2011->	1		0,8	D8EA	2120	DR8EA	7162
250	SRE 250	250	2011->	1		0,8	D8EA	2120	DR8EA	7162
250	SRM 250	250	2011->	1		0,8	D8EA	2120	DR8EA	7162
250	SRT 250	250	2011->	1		0,8	D8EA	2120	DR8EA	7162
250	SRX 250	250	2011->	1		0,8	D8EA	2120	DR8EA	7162
250	VOYGER 250	250	2011->	1		0,8	C7HSA	4629	CR7HSA	4549
250	XTG250	250	2011->	1		0,8	D8EA	2120	DR8EA	7162
450	MXR 450	450	2011->	1		1,1	IFR8H-11	5068	BKR8E-11	6587
450	SMR 450 FI	450	2011->	1		1,1	IFR8H-11	5068	BKR8E-11	6587

BIMOTA										
500	500 V-DUE	500	1993->	1		0,8	BR9ES	5722		
600	YB9 BELLARIA	600	1990->1993	4		0,8	CR9E	6263		
600	YB9 SR	600	1994->1996	4		0,8	CR9E	6263		
650	BIPOSTO BB1	650	1996->1997	1		0,8	D8EA	2120		
750	DB-1S	750	1986->1987	2		0,8	BP7HS	5111		
750	HB1	750	1975->1976	4		0,8	DR8EA	7162		
750	SB7	750	1994->1995	4		0,8	CR9EK	4548		
750	YB4	750	1988->1989	4		0,8	DR8EA	7162		
851	TESI1	851	1990->1991	4		0,8	DR9EIX	4772		
900	DB2	900	DPR8EA-9->	2		0,9	DPR8EA-9	4929		
900	HB2	900	1982->1983	4		0,8	DR8EA	7162		
904	DB3 MANTRA	904	1995->1998	2		0,9	DPR8EA-9	4929		
1000	SB8R	1000	1998->1999	4		0,8	CR9EK	4548		
1000	YB6	1000	1988->1990	4		0,8	DR8ESL	2923		
1000	YB8 EXUP	1000	1995->1995	4		0,8	DR8ESL	2923		
1002	YB11	1002	1996->1998	4		0,8	DR8EA	7162		
1078	DB5 S	1078	2010->	2		0,8	DCPR8E	4339		
1078	DB6 R DELIRIO	1078	2008->	2		0,8	DCPR8E	4339		
1078	TESI3 D	1078	2010->	2		0,8	DCPR8E	4339		
1100	DB5	1100	2005->2006	2		0,8	DCPR8E	4339		
1100	DB6	1100	2007->	2		0,8	DCPR8E	4339		
1100	DB7	1100	2009->	2		0,8	MAR10A-J	4706		
1100	HB3	1100	1983->1985	4		0,8	DR8EA	7162		
1100	SB6	1100	1994->1996	4		0,8	CR9E	6263		
1100	SB6 R	1100	1997->1998	4		0,8	CR9E	6263		
1150	SB5	1150	1985->1986	4		0,9	DPR9EA-9	5329	DPR9EIX-9	5545
1200	YB5	1200	1987->1988	4		0,9	DPR8EA-9	4929		



MOTOR CYCLES



Model	Type	Capacity	Year	Cyl	Engine	Gap	Recommended	Stock Code	Alternative	Stock Code
BMW										
450	G450C	450	2008->	1		0,8	CR9EK	4548		
450	G450X	450	2008->	1		0,8	CR9EK	4548		
500	R50 & R51 SERIES 12.7MM REACH	500	1951->1954	2		0,7	B7HS	5110	BR7HS	4122
500	R50 & R51 SERIES 19.0MM REACH	500	1955->1969	2		0,8	B8ES	2411	BR8ES	5422
500	R50/5	500	1969->1973	2		0,8	BPR7ES	95164		
600	R60 & R69 SERIES 12.7MM REACH	600	1956->1969	2		0,8	BR8HIX	7001	BR8HS	4322
600	R60/5,6,7	600	1976->1978	2		0,8	BPR6ES	96989		
600	R60 & R69 SERIES 19.0MM REACH	600	1956->1969	2		0,8	B8ES	2411	BR8ES	5422
650	C650 SPORT	650	2016->	2		0,8	LMAR8D-J	93444		
650	F650	650	2004->	1		0,6	DR8EB	4855	DR8EA	7162
650	F650 DAKAR	650	2000->2003	1		0,8	DR8EA	7162		
650	F650 DAKAR/M	650	2003->2006	1		0,8	DR8EA	7162		
650	F650 FUNDURO	650	1999->	2		0,8	BCPR7ET	2164		
650	F650 FUNDURO	650	2000->2003	1		0,7	DR8EA	7162		
650	F650 GS	650	2007->2010	1		0,8	DCPR8E	4339		
650	F650 GS/DAKAR	650	2004->2004	1		0,8	DR8EA	7162		
650	F650 GS/DAKAR	650	2005->2006	1		0,8	DR8EA	7162		
650	F650 S/M	650	2003->2007	1		0,8	DR8EA	7162		
650	F650GS	650	2003->2007	1		0,6	DR8EB	4855	DR8EA	7162
650	G650 XCHALLENGE XCOUNTRY XMOTO	650	2007->	1		0,8	DR8EA	7162		
650	G650X CHALLENGE	650	2007->	1		0,8	DR8EA	7162		
650	G650X COUNTRY	650	2007->	1		0,8	DR8EA	7162		
650	R65	650	1978->	2		0,8	BPR7ES	95164		
700	F 700 GS	700	2013->	2		0,8	DCPR8E	4339		
750	F750GS	750	2016->	2		0,9	LMAR8J-9E	93972		
750	K75C, K75S	750	1985->1996	3		0,7	D8EA	2120	DR8EA	7162
750	R75/5, R75/6, R75/7	750	1970->	3		0,8	BPR6ES	96989		
800	F 800 GT	800	2013->	2		0,8	DCPR8E	4339		
800	F 800R	800	2009->	2		0,8	DCPR8E	4339		
800	F650GS	800	2008->	2		0,8	DCPR8E	4339		
800	F800GS	800	2008->	2		0,8	DCPR8E	4339		
800	F800S,ST	800	2006->	2		0,8	DCPR8E	4339		
800	R80GS	800	1980->1994	2		0,8	BPR6ES	96989		
800	R80/7, R80G, R80S	800	1982->1995	2		0,8	BPR6ES	96989		
850	F850GS	850	2016->	2		0,9	LMAR8J-9E	93972		
850	R850R	850	1999->2000	2		0,8	BKR7EKC	7354		
900	R90/6, R90S	900	1976->	2		0,8	BPR6ES	96989		
1000	GS100	1000	1989->	2		0,8	BPR6ES	96989		
1000	K100RS4V	1000	1989->1992	4		0,7	D9EA	2420		
1000	K100, K100RS, K100RT 72KW	1000	1990->1993	4		0,7	D8EA	2120	DR8EA	7162
1000	R100GS	1000	1985->	2		0,8	BPR6EIX	6637	BP6ES	91076
1000	R100/7, 100S, 100RS	1000	->1986	2		0,8	BPR6ES	96989		
1000	S1000RR	1000	2009->	4		0,8	LMAR9D-J	1633		
1100	K1100LT	1100	1999->	4		0,7	DR7EA	7839		
1100	R1100 S	1100	2003->	2		0,8	BKR7EKC+DCPR8EKC	7354+7168		
1100	R1100RT	1100	1995->2001	2		0,8	BKR7EKC	7354		
1100	R1100 RS	1100	1992->2001	2		0,8	BCP7ET	2078		
1150	R1150GS,R,RT	1150	1999->2003	2		0,8	BKR7EKC+DCPR8EKC	7354+7168		
1150	R1150R,RT	1150	2001->2003	2		0,8	BKR7EKC	7354		
1200	HP2 MEGAMOTO 1200	1200	2007->	2		0,7	DCPR8EKC	7168		
1200	K1200GT	1200	2006->	4		0,8	KR9CI	7795	DCPR9E	2641
1200	K1200R	1200	2006->	4		0,8	KR9CI	7795	DCPR9E	2641
1200	K1200R SPORT	1200	2007->	4		0,8	KR9CI	7795	DCPR9E	2641
1200	K1200RS	1200	1997->2003	4		0,7	DCPR7E	3932		
1200	K1200S	1200	2004->	4		0,8	KR9CI	7795	DCPR9E	2641
1200	K1200/RS,LT	1200	1997->	4		0,8	BKR6EK	94007		
1200	R1200C	1200	->2003	2		0,8	BKR7EKC	7354		
1200	R1200GS	1200	2005->	2		0,7	DCPR8EKC	7168		
1200	R1200GS	1200	2009->	2		0,7	DCPR8EKC	7168		
1200	R1200GS	1200	2010->	2		0,8	MAR8B-JDS	8765		
1200	R1200GS	1200	2014->	2		0,8	LMAR8D-J	93444		
1200	R1200R	1200	2007->	2		0,7	DCPR8EKC	7168		
1200	R1200R	1200	2010->	2		0,8	MAR8B-JDS	8765		
1200	R1200RT	1200	2006->2008	2		0,7	DCPR8EKC	7168		
1200	R1200RT	1200	2009->2010	2		0,7	DCPR8EKC	7168		
1200	R1200RT	1200	2011->	2		0,8	MAR8B-JDS	8765		
1200	R1200RT,ST	1200	2006->	2		0,7	DCPR8EKC	7168		
1200	R1200S	1200	2006->	2		0,7	DCPR8EKC	7168		
1200	R1200ST	1200	2006->	2		0,7	DCPR8EKC	7168		
1300	K1300GT	1300	2009->	4		0,8	KR9CI	7795	DCPR9E	2641
1300	K1300R	1300	2009->	4		0,8	KR9CI	7795	DCPR9E	2641
1300	K1300S	1300	2009->	4		0,8	KR9CI	7795	DCPR9E	2641
1600	K1600 GT	1600	2011->	6		0,8	LMAR8AI-8	92288		
1600	K1600GTL	1600	2011->	6		0,8	LMAR8AI-8	92288		

MOTORCYCLES



MOTOR CYCLES



Model	Type	Capacity	Year	Cyl	Engine	Gap	Recommended	Stock Code	Alternative	Stock Code
BUELL										
1000	FIREBOLT XB9R 1000	1000	2002->2007	2		0,8	DCPR8E	4339		BUELL
1000	XB9S 1000	1000	2003->2007	2		0,8	DCPR9E	2641		
1000	XB9SX 1000	1000	2006->2007	2		0,8	DCPR9E	2641		
1125	1125 CR	1125	2009->2010	2		0,8	CR9EK	4548		
1125	1125 R	1125	2008->	2		0,8	CR9EK	4548		
1200	LIGHTNING X1 1200	1200	1999->2005	2		0,8	DCPR8E	4339		
1200	M2 CYCLONE 1200	1200	1997->1998	2		0,8	DCPR8E	4339		
1200	S1 LIGHTNING B,H1 1200	1200	1996->1997	2		0,8	DCPR8E	4339		
1200	S1 WHITE LIGHTNING 1200	1200	1998->	2		0,7	DCPR7E	3932		
1200	S3T BOLT,BOLT TOUR 1200	1200	1997->	2		0,8	DCPR8E	4339		
1200	XB12R 1200	1200	2007->	2		0,8	DCPR9E	2641		
1200	XB12S TT 1200	1200	2004->2007	2		0,8	DCPR9E	2641		
1200	XB12S TT 1200	1200	2007->	2		0,8	DCPR9E	2641		
1200	XB12SS,X 1200	1200	2006->2007	2		0,8	DCPR9E	2641		
1200	XB12XT 1200	1200	2008->	2		0,8	DCPR9E	2641		
CAGIVA										
125	125R,D	125	1999->	1		0,8	BR9EG	3230	BR9ES	5722
125	MITO SP525	125	2008->	1		0,8	BR9EG	3230	BR9ES	5722
125	MITO, E,V 125	125	2001->2003	1		0,8	BR9EG	3230	BR9ES	5722
125	PLANET 125	125	1999->2003	1		0,8	BR9EG	3230	BR9ES	5722
125	SUPERCITY 125	125	1999->	1		0,8	BR9EG	3230	BR9ES	5722
125	SUPERCITY 125R,D	125	1999->	1		0,8	BR9EG	3230	BR9ES	5722
900	CANYON 900	900	1999->	2		0,9	DPR8EA-9	4929		
1000	NAVIGATOR 1000	1000	1999->	2		0,8	CR8EK	3478		
1000	RAPTOR 1000	1000	1999->	2		0,8	CR8EK	3478		
1000	V-RAPTOR 1000	1000	2000->	2		0,8	CR8EK	3478		
1000	X-TRA RAPTOR 1000	1000	2003->	2		0,8	CR8EK	3478		
1000	X-TRA RAPTOR 1000	1000	2004->	2		0,8	CR8EK	3478		
CAN-AM										
1000	SPYDER ROADSTER 1000	1000	2008->	2		0,8	DCPR9E	2641		CAN-AM
DERBI										
125	TERRA 125	125	2008->	1		0,8	CR8E	1275		DERBI
DUCATI										
400	MONSTER	400	->2005	2		0,8	DCR8EIX	3606		
500	500GTL, SPORT DESMO	500	1974->1979	2		0,7	B7HS	5110	BR7HS	4122
500	500SL PANTAH	500	1980->1984	2		0,7	BP7HS	5111		
600	600M,MS,MD	600	1994->2001	2		0,8	DCPR8EIX	6546		
600	600SL PANTAH	600	81->	2		0,7	BP7HS	5111		
600	600SS,MONSTER	600	1994->1997	2		0,9	DPR9EA-9	5329	DPR9EIX-9	5545
600	MONSTER	600	1994->2001	2		0,8	DCR8EIX	3606		
620	MULTISTRADA 620	620	2005->	2		0,8	DCPR8E	4339		
696	MONSTER 700	700	2007->	2		0,8	DCPR8E	4339		
750	F1 750	750	1985->	2		0,7	D8EA	2120	DR8EA	7162
750	PASO 750	750	1986->	2		0,7	D8EA	2120	DR8EA	7162
750	748 BIPOSTO	750	1995->2004	2		0,9	DCPR9EIX	2316	DCPR9E	2641
750	GT,S,SPORT 750	750	1974->1990	2		1	BPR7HS-10	1092		
750	MONSTER	750	1997->2002	2		0,8	DCR8EIX	3606		
750	SPECIAL SS 750	750	1972->1974	2		1	BPR7HS-10	1092		
750	SS 750	750	1991->	2		0,8	DCPR8EIX	6546		
750	SUPERBIKE 749,S, DARK 750	750	2005->2006	2		0,8	CR9EIX	3521	CR9E	6263
800	800 HYPERMOTARD	800	2013->	2		0,8	MAR9A-J	6869		
800	MONSTER	800	2003->	2		0,8	DCR8EIX	3606		
803	MONSTER 796	803	2010->	2		0,8	DCPR8E	4339		
803	MONSTER S2R	803	2006->	2		0,8	DCPR8E	4339		
848	SP 850	850	2007->	2		0,8	MAR10A-J	4706		
860	GT,GTS,S 860	860	1975->	2		0,5	B5HS	4210		
899	899 PANIGALE	899	2013->	2		0,8	MAR9A-J	6869		
900	SS,SD,S2 900	900	1980->1987	2		0,7	B7HS	5110	BR7HS	4122
916	ST4 916	916	1998->2003	2		0,7	DCPR9EIX	2316	DCPR9E	2641
939	HYPERMOTARD 939	939	2016->	2		0,8	MAR9A-J	6869		
939	HYPERSTRADA 939	939	2016->	2		0,8	MAR9A-J	6869		
939	SUPERSPORT 939	939	2017->	2		0,8	MAR9A-J	6869		
944	ST2 944	944	1997->2003	2		0,9	DCPR9EIX	2316	DCPR9E	2641
959	PANIGALE 959	959	2016->	2		0,8	MAR9A-J	6869		
989	DESMOSEDICI RR 989	989	2007->	2		0,8	MAR10A-J	4706		
990	DESMO 16 RR 990	990	2007->	4		0,8	MAR10A-J	4706		



MOTOR CYCLES



Model	Type	Capacity	Year	Cyl	Engine	Gap	Recommended	Stock Code	Alternative	Stock Code
DUCATI						DUCATI				
996	BIP,SPS,SPSF 996	996	1998->	2		0,7	DCPR9EIX	2316	DCPR9E	2641
998	SP 998	998	2006->	2		0,8	MAR10A-J	4706		
999	RS 999	999	2003->	2		0,8	CR9EB	6955		
999	RS 999	999	2005->	2		0,7	DCPR9EIX	2316	DCPR9E	2641
1000	CLASSIC SPORT 1000	1000	2006->	2		0,8	DCPR8E	4339		
1000	MULTISTRADA S DS 1000	1000	2005->	2		0,9	DPR8EA-9	4929		
1000	M,H MILLE 1000	1000	1981->1985	2		0,7	B7HS	5110	BR7HS	4122
1000	S2R MONSTER 1000	1000	2006->	2		0,8	DCPR8E	4339		
1000	ST3 1000	1000	2004->2008	2		0,8	CR9EIX	3521	CR9E	6263
1078	HYPERMOTARD 1078	1078	2007->	2		0,8	DCPR8E	4339		
1098	S 1099	1099	2007->	2		0,8	MAR10A-J	4706		
1100	HYPERMOTARD 1100	1100	2010->	2		0,8	DCPR8E	4339		
1100	MONSTER 1100	1100	2009->	2		0,8	DCPR8E	4339		
1100	MULTISTRADA 1100	1100	2007->	2		0,8	DCPR8E	4339		
1100	PANIGALE V4	1100	2018->	4		0,8	LMR10A-JS	97718		
1100	STREETFIGHTER /S 1100	1100	2009->	2		0,8	MAR10A-J	4706		
1198	MULTISTRADA 1198	1198	2010->	2		0,8	MAR9A-J	6869		
1198	R,S 1198	1198	2008->	2		0,8	MAR10A-J	4706		
1199	PANIGALE 1199	1199	2013->	2		0,8	MAR9A-J	6869		
1199	PANIGALE 1199 R	1199	2016->	2		0,8	MAR9A-J	6869		
1200	BRUTALE 1098 R	1200	2008->	2		0,8	CR9EB	6955		
1200	DIAVEL 1200	1200	2010->	2		0,8	MAR9A-J	6869		
1200	DIAVEL 1200 AMG	1200	2013->	2		0,8	MAR9A-J	6869		
1200	DIAVEL 1200 CARBON	1200	2011->	2		0,8	MAR9A-J	6869		
1200	F4 1098 RR	1200	2008->	2		0,8	CR9EB	6955		
1200	MONSTER 1200 R	1200	2016->	2		0,8	MAR9A-J	6869		
1200	MULISTRADA 1200	1200	2013->	2		0,8	MAR10A-J	4706		
1200	MULTISTRADA 1200 GT	1200	2013->	2		0,8	MAR10A-J	4706		
1299	1299 S PANIGALE	1300	2017->	2		0,8	MAR9A-J	6869		

GAS GAS						GAS GAS				
125	ENDURO 125	125	2002->	1		0,8	BR8EIX	5044	BR8ES	5422
250	EC 250 ENDURO CROSS	250	2002->	1		0,8	BR8EIX	5044	BR8ES	5422

GENERAL						GENERAL				
150	COUGAR 150	150	1980->1982	1		0,7	C7HSA	4629	CR7HSA	4549
250	COUGAR 250	250	1980->1982	1		0,7	C7HSA	4629	CR7HSA	4549

GOMOTO						GOMOTO				
70	CRF 70	70	2011->	1		0,8	C7HSA	4629	CR7HSA	4549
100	TRANSPORTER 100	100	2011->	1		0,8	C7HSA	4629	CR7HSA	4549
125	CRF 125 BIG WHEEL	125	2011->	1		0,8	C7HSA	4629	CR7HSA	4549
125	CRF 125 SMALL WHEEL	125	2011->	1		0,8	C7HSA	4629	CR7HSA	4549
125	FREEDOM 125	125	2011->	1		0,8	C7HSA	4629	CR7HSA	4549
125	XPLORE 125	125	2011->	1		0,8	C7HSA	4629	CR7HSA	4549
125	ZR-125	125	2011->	1		0,8	C7HSA	4629	CR7HSA	4549
150	FREEDOM 150	150	2011->	1		0,8	C7HSA	4629	CR7HSA	4549
150	XPLORE 150	150	2011->	1		0,8	C7HSA	4629	CR7HSA	4549
200	X-ACT 200	200	2011->	1		0,8	D8EA	2120	DR8EA	7162
200	ZR-200	200	2011->	1		0,8	D8EA	2120	DR8EA	7162
230	LYNX 230	230	2011->	1		0,8	D8EA	2120	DR8EA	7162
250	INTRUDER 250	250	2011->	1		0,8	D8EA	2120	DR8EA	7162

HARLEY DAVIDSON						HARLEY DAVIDSON				
883	883 IRON	880	2008->	2		0,9	DCPR7EA-9	6651		
1130	VRSC-V-ROD 1130	1130	2002->	2		0,8	DCPR8E	4339		
1200	DUO GLIDE, ELECTRA GLIDE, FL 1200	1200	2010->	2		0,6	BP5S	3011		
1200	EVOLUTION XL V-2 1200	1200	1986->2005	2		0,7	DCPR7E	3932		
1200	FLH, FX, FXE 1200	1200	1974->	2		0,6	BP5S	3011		
1200	FLH, FX, FXE 1200	1200	1975->1980	2		1,1	BP5ES-11	7311	BPR5ES-11	4424
1200	SPORSTER EVOLUTION XL1200R	1200	2004->	2		0,7	DCPR7E	3932		
1200	SPORTSTER NIGHTSTER 1200	1200	2008->	2		0,8	DCPR8E	4339		
1200	SPORTSTER XR 1200	1200	2008->	2		0,8	DCPR8E	4339		
1200	XL1200R SPORTSTER	1200	2004->	2		0,7	DCPR7E	3932		
1200	XR 1200 X	1200	2010->	2		0,8	DCPR8EIX	6546		
1250	V ROD VRSCAW 1250	1250	2008->	2		0,8	DCPR8E	4339		
1340	SHOVEL HEAD: ALL MODELS 1340	1340	1978->1981	2		1,1	BP5ES-11	7311	BPR5ES-11	4424
1340	SHOVEL HEAD: FLT, FLHT 1340	1340	1984->	2		1,1	BP5ES-11	7311	BPR5ES-11	4424
1340	SHOVEL HEAD: FLT, FX, FXB 1340	1340	1982->1983	2		1	ZGR5A	5839		
1340	SHOVEL HEAD: FL, FLH, FLHS 1340	1340	1982->1983	2		1	ZGR5A	5839		



MOTOR CYCLES



Model	Type	Capacity	Year	Cyl	Engine	Gap	Recommended	Stock Code	Alternative	Stock Code
HARLEY DAVIDSON						HARLEY DAVIDSON				
1340	SHOVEL HEAD: FX5B 1340	1340	1983>1984	2		1	ZGR5A	5839		
1340	SHOVEL HEAD: FXE 1340	1340	1982>1984	2		1	ZGR5A	5839		
1340	SHOVEL HEAD: FXEF, FXRS 1340	1340	1982>1983	2		1	ZGR5A	5839		
1340	SHOVEL HEAD: FXRS, FXRT, FXST 1340	1340	1984>	2		1,1	BP5ES-11	7311	BPR5ES-11	4424
1340	SHOVEL HEAD: FXR, FXS 1340	1340	1982>1983	2		1	ZGR5A	5839		
1340	SHOVEL HEAD: FXWG 1340	1340	1984>	2		1	ZGR5A	5839		
1340	V2 EVOLUTION: FLT, FLHT, FXRD 1340	1340	1985>	2		1,1	BP5ES-11	7311	BPR5ES-11	4424
1340	V2 EVOLUTION: FXRS, FXRT, FXSB 1340	1340	1985>	2		1,1	BP5ES-11	7311	BPR5ES-11	4424
1340	V2 EVOLUTION: FXST, FXWG, GXE 1340	1340	1985>	2		1,1	BP5ES-11	7311	BPR5ES-11	4424
1450	DYNA SUPER GLIDE 1450	1450	2005>	2		0,7	DCPR7E	3932		
1450	FL TC88 1450	1450	1998>2005	2		0,7	DCPR7E	3932		
1584	DYNA FAT BOB 1584	1584	2008>	2		0,8	DCPR8E	4339		
1584	FLSTSB CROSSBONES 1584	1584	2008>	2		0,8	DCPR8E	4339		
1584	FX TC 96/B 1584	1584	2007>	2		0,8	DCPR8E	4339		
1584	TOURING ROAD GLIDE 1584	1584	2010>	2		0,8	DCPR8E	4339		
1584	TRI GLIDE ULTRA 1584	1584	2009>	2		0,8	DCPR8E	4339		
1585	SOFT TAIL ROCKER 1585	1585	2008>	2		0,8	DCPR8E	4339		
1586	DYNA FAT BOB 1586	1586	2008>	2		0,8	DCPR8E	4339		
1586	DYNA LOW RIDER 1586	1586	2007>2009	2		0,8	DCPR8E	4339		
1586	DYNA STREET BOB 1586	1586	2007>2010	2		0,8	DCPR8E	4339		
1586	DYNA WIDE GLIDE 1586	1586	2007>2010	2		0,8	DCPR8E	4339		
1586	SOFTAIL DELUXE 1586	1586	2007>2010	2		0,8	DCPR8E	4339		
1586	SOFTAIL FATBOY 1586	1586	2007>2010	2		0,8	DCPR8E	4339		
1586	SOFTAIL HERITAGE 1586	1586	2007>2010	2		0,8	DCPR8E	4339		
1586	TOURING ELCTRA GLIDE 1586	1586	2007>2010	2		0,8	DCPR8E	4339		
1586	TOURING ROAD KING 1586	1586	2007>2010	2		0,8	DCPR8E	4339		
1586	TOURING STREET GLIDE 1586	1586	2007>2010	2		0,8	DCPR8E	4339		
1800	CVO 1800	1800	2009>	2		0,8	DCPR8E	4339		

HONDA						HONDA				
50	BF50	50	1972>1978	1		0,8	BPR5ES	94084		
50	CD50	50	1973>1983	1		0,7	C6HSA	3228	CR6HSA	2983
50	CRF50F	50	2007>	1		0,7	CR6HSA	2983		
50	MB50	50	1982>	1		0,8	B8HS	5510	BR8HS	4322
50	MBX50SD	50	1992>1995	1		0,5	B6ES	7310		
50	MBX50,FWDF	50	1989>1997	1		0,8	B9ES	2611	BR9ES	5722
50	MT50	50	1974>1975	1		0,8	B8HS	5510	BR8HS	4322
50	MT50FL	50	1980>1993	1		0,8	B8ES	2411	BR8ES	5422
50	MTX50R,RFF	50	1995>1998	1		0,8	B8ES	2411	BR8ES	5422
50	NC50	50	1982>1983	1		0,7	BP4HS	3611	BPR4HS	7823
50	NH50,MDD	50	1993>	1		0,6	BP6HS	4511	BPR6HS	7022
50	NS50	50	1981>1985	1		0,7	BP5HS	4111		
50	NS50D	50	1990>	1		0,7	BP4HS	3611	BPR4HS	7823
50	NS50FL	50	1990>1990	1		0,8	B8ES	2411	BR8ES	5422
50	PZ-50	50	1969>1970	1		0,6	BP6HS	4511	BPR6HS	7022
50	QR50R,M,N	50	1970>1975	1		0,7	BP4HS	3611	BPR4HS	7823
50	QR50V	50	1975>1977	1		0,7	BP5HS	4111		
50	SE-50 (IDK)	50	1988>	1		0,7	BP4HS	3611	BPR4HS	7823
50	SE50	50	1987>1990	1		0,6	BP6HS	4511	BPR6HS	7022
50	SK-50	50	1973>	1		0,7	D8EA	2120	DR8EA	7162
50	VISION 50	50	2004>	1		0,8	BP8HS	2630	BPR8HS	3725
50	Z50	50	1979>1981	1		0,7	C6HSA	3228	CR6HSA	2983
50	Z50J,RM,RN	50	1986>	1		0,7	C6HSA	3228	CR6HSA	2983
60	CR60R	60	1983>	1		0,8	B9ES	2611	BR9ES	5722
70	ATC70,K	70	1968>1970	1		0,7	C7HSA	4629	CR7HSA	4549
70	C70	70	1982>1983	1		0,7	C7HSA	4629	CR7HSA	4549
70	CT70,H	70	1970>1971	1		0,7	C7HSA	4629	CR7HSA	4549
70	R,D 70	70	1997>	1		0,7	CR6HSA	2983		
80	CR80R	80	1984>	1		0,8	B9ES	2611	BR9ES	5722
80	CR80R	80	1986>	1		0,6	B10ES	7928		
80	CR80R,R II	80	1985>	1		0,8	B9ES	2611	BR9ES	5722
80	MB80,S	80	1983>1986	1		0,8	B8HS	5510	BR8HS	4322
80	MT80	80	1983>1986	1		0,8	B9HS	5810	BR9HS	4522
80	NH80 (LEAD/AERO)	80	1982>1986	1		0,6	BP6HS	4511	BPR6HS	7022
80	XR80RS,T	80	1985>2003	1		0,8	CR7HSA	4549	CR7HIX	7544
85	CR85R	85	2003>2006	1		0,8	BR10EG	3830		
85	CR85R	85	2007>	1		0,8	B10EG	3630	BR10EG	3830
85	CR85R2	85	2007>	1		0,8	BR10EG	3830		
90	C90	90	1979>1983	1		0,6	D6HS	6812		
90	CT90,K	90	1966>1979	1		0,7	D8HS	7012		
100	CB100	100	1970>1972	1		0,7	D8EA	2120	DR8EA	7162
100	CD100	100	1997>2001	1		0,7	C7HSA	4629	CR7HSA	4549
100	CRF100F	100	2007>	1		0,8	CR7HIX	7544		

- DIESEL VEHICLE |



MOTOR CYCLES



Model	Type	Capacity	Year	Cyl	Engine	Gap	Recommended	Stock Code	Alternative	Stock Code
HONDA										
100	H100	100	1985->1989	1		0,7	B7HS	5110	BR7HS	4122
100	H100S	100	1980->1992	1		0,8	B8HS	5510	BR8HS	4322
100	JET 100	100	1981->1982	1		0,8	BR6HS	3922		
100	MB100	100	1989->1990	1		0,7	B7HS	5110	BR7HS	4122
100	NH100	100	1990->	1		0,8	BR7HS	4122		
100	XL100R	100	1979->1985	1		0,7	C7HSA	4629	CR7HSA	4549
100	XR100RT	100	1981->	1		0,8	CR7HIX	7544		
110	CRF 110	110	2013->	1		0,9	CPR6EA-9S	1582		
110	CT110	110	1985->	1		0,7	D8EA	2120	DR8EA	7162
110	CT110P	110	1985->	1		0,7	D8HS	7012		
125	A125	125	1982->1985	1		0,7	C7HSA	4629	CR7HSA	4549
125	ANF125	125	2007->	1		0,9	CPR6EA-9S	1582		
125	ATC125M	125	1987->1989	1		0,7	D8EA	2120	DR8EA	7162
125	CA125	125	1995->	1		0,7	CR6HSA	2983		
125	CBF 125 M	125	2009->	1		0,9	CPR7EA-9	3901		
125	CBF125	125	2009->	1		0,9	CPR8EA-9	2306		
125	CBR 125R	125	2004->2006	1		0,8	CR9E	6263		
125	CBR 125R	125	2007->2010	1		0,8	CR8E	1275		
125	CG125F3	125	1998->	1		0,7	D8EA	2120	DR8EA	7162
125	CG125P	125	1976->1996	1		0,9	DP8EA-9	5829	DPR8EA-9	4929
125	CG125_S5,SP	125	1976->1996	1		0,7	D8EA	2120	DR8EA	7162
125	CH125	125	1984->	1		0,9			DPR7EA-9	5129
125	CR125M	125	1974->1981	1		0,8	B9ES	2611	BR9ES	5722
125	CR125R	125	2007->	1		0,8	B9ES	2611	BR9ES	5722
125	CR125R	125	2007->	1		0,8	CR8E	1275		
125	LS125	125	1997->	1		0,8	B8ES	2411	BR8ES	5422
125	NES125_Y,ES	125	2000->	1		0,9	CR8EH-9	5666		
125	NH 125 JFD1	125	1983->1996	1		0,8	BPR6HIX	4085		
125	NH125 (LEAD, AERO)	125	1984->	1		0,6	BP6HS	4511	BPR6HS	7022
125	NSS FORZA AD	125	2015->	1	JB 60 A&B	0,9	SILMAR8C9	90097		
125	NX125	125	1988->1990	1		0,7	DR8EA	7162		
125	SH125	125	2001->	1		0,9	CR8EH-9	5666		
125	TL125_K,S	125	1973->1976	1		0,7	D8EA	2120	DR8EA	7162
125	VARADERO 125	125	2008->	1		0,9	CR8EH-9	5666		
125	VARADERO 125	125	2008->	1		0,9	CR8EH-9	5666		
125	VT125	125	2000->	1		0,9	CR8EH-9	5666		
125	XL125	125	1975->1987	1		0,7	D8EA	2120	DR8EA	7162
125	XL125S_SD,DUTY	125	1974->1978	1		0,7	D8EA	2120	DR8EA	7162
125	XL125V	125	2007->	1		0,9	CR8EH-9	5666		
125	XL125VF	125	2001->	1		0,9	CR8EH-9	5666		
125	XLR125	125	1997->1999	1		0,9	DPR8EA-9	4929		
125	XR125L	125	2003->	1		0,9	DPR9EA-9	5329	DPR9EIX-9	5545
135	HX135	135	1989->1995	1		0,7	D8EA	2120	DR8EA	7162
150	CRF150F	150	2003->2006	1		0,9	CPR8EA-9	2306		
150	CRF150R	150	2006->	1		0,9	CR8EH-9	5666		
150	CRF150RB	150	2008->	1		0,8	RO409B-8	7791		
150	NSR150R	150	1995->2002	1		0,8	B8ES	2411	BR8ES	5422
150	XR 150	150	2014->	1		0,9	CPR8EA-9	2306		
175	CB175,K	175	1969->1973	1		0,7	D8HS	7012		
175	CL175,K	175	1968->1973	1		0,7	D8HS	7012		
175	XL175	175	1973->1978	1		0,8	BR8ES	5422		
185	ATC185_A,S	185	1982->1983	1		0,7	D8EA	2120	DR8EA	7162
185	XL185S_SD	185	1979->	1		0,7	D8EA	2120	DR8EA	7162
200	CB200,B,T	200	1974->1976	1		0,7	D8EA	2120	DR8EA	7162
200	CB250_NIGHTHAWK	200	1991->2007	1		0,7	CR6HSA	2983		
200	CD200T	200	1985->	1		0,7	C7HSA	4629	CR7HSA	4549
200	CD200T ROAD MASTER	200	1980->1985	1		0,7	C7HSA	4629	CR7HSA	4549
200	CL200	200	1974->	1		0,7	D8EA	2120	DR8EA	7162
200	CT200	200	1980->1981	1		0,7	DR8ESL	2923		
200	CT200K	200	1992->1994	1		0,7	D8EA	2120	DR8EA	7162
200	TLM200R	200	1983->1985	1		0,8	B8ES	2411	BR8ES	5422
200	XL200 SUPER	200	1983->1984	1		0,7	D8EA	2120	DR8EA	7162
200	XL200R	200	1984->1985	1		0,7	D8EA	2120	DR8EA	7162
200	XLR 200	200	1986->1987	1		0,9	DPR8EA-9	4929		
200	XR200R	200	1986->2002	1		0,9	DP8EA-9	5829	DPR8EA-9	4929
200	XR200RM/RP	200	1981->1983	1		0,7	D8EA	2120	DR8EA	7162
200	XR200/R	200	1983->	1		0,7	D8EA	2120	DR8EA	7162
230	CRF230F	230	2003->2006	1		0,9	DPR7EA-9	5129		
230	SL 230	230	1998->	1		0,9	DPR8EA-9	4929		
250	CB250 NIGHTHAWK	250	1991->2006	1		0,7	CR6HSA	2983		
250	CB250RS	250	1980->	1		0,7	D8EA	2120	DR8EA	7162
250	CB250,G	250	1996->	1		0,8	B8ES	2411	BR8ES	5422
250	CBF250	250	2005->	1		0,9	CR8EH-9	5666		
250	CBF250	250	2006->	1		0,9	CR8EH-9	5666		



MOTOR CYCLES



Model	Type	Capacity	Year	Cyl	Engine	Gap	Recommended	Stock Code	Alternative	Stock Code
HONDA										
250	CBR250 R	250	2010->	1		0,9	SIMR8A-9	91064		
250	CBR250RR	250	2017->	1		0,9	SILMAR8C9	90097		
250	CMX250C,REBEL	250	1996->2006	1		0,7	CR6HSA	2983		
250	CR250	250	1978->1981	1		0,8	B9ES	2611	BR9ES	5722
250	CR250M	250	1973->1976	1		0,8	B9ES	2611	BR9ES	5722
250	CR250R	250	2003->	1		0,8	BR8ES	5422		
250	CR250R	250	2005->	1		0,8	BR9EG	3230	BR9ES	5722
250	CR250R	250	2005->2006	1		0,9	BR9EG	3230	BR9ES	5722
250	CRF250	250	2005->	1		0,9	CR8EH-9	5666		
250	CRF250	250	2009->	1		0,8	R0451B-8	9356		
250	CRF250 L	250	2013->	2		0,9	SIMR8A-9	91064		
250	CRF250F	250	2009->	1		0,8	R0451B-8	9356		
250	CRF250R	250	2004->2004	1		0,9	IMR9C-9H	6777	CR9EH-9	7502
250	CRF250R	250	2005->	1		0,8	R0409B-8	7791		
250	CRF250R	250	2005->2006	1		0,8	R0409B-8	7791		
250	CRF250X	250	2004->2004	1		0,9	IMR8C-9H	3653	CR8EH-9	5666
250	CRF250X	250	2007->	1		0,8	R0409B-8	7791		
250	CRM250 X	250	1999->2000	1		0,8	BR8ES	5422		
250	MR250	250	1976->	1		0,8	B8ES	2411	BR8ES	5422
250	PS250 BIG RUCKUS	250	2005->2006	1		0,9	DPR7EA-9	5129		
250	SL250S	250	1987->1989	1		0,7	D8EA	2120	DR8EA	7162
250	TL250	250	1975->1976	1		0,7	D7EA	7912	DR7EA	7839
250	TLR250R	250	1986->1989	1		0,7	D8EA	2120	DR8EA	7162
250	TRX250	250	1987->1989	1		0,7	D8EA	2120	DR8EA	7162
250	XL250	250	>1983	1		0,7	D8EA	2120	DR8EA	7162
250	XL250R	250	1984->	1		0,7	D8EA	2120	DR8EA	7162
250	XR250 L	250	2002->2008	1		0,9	CR8EH-9	5666		
250	XR250 TORNADO	250	2009->	1		0,9	CR8EH-9	5666		
250	XR250R	250	1983->	1		0,7	D8EA	2120	DR8EA	7162
260	TLM260R	260	1983->1989	1		0,5	B6ES	7310		
280	SH280	280	2007->	1		0,9	LMAR8AI-8	92288		
300	CBR 300 R	300	2015->	1		0,9	SIMR8A-9	91064		
350	CB350F	350	1972->1974	4		0,7	D8EA	2120	DR8EA	7162
350	CB350,G	350	1971->1972	2		0,8	BR8ES	5422		
350	NX350	350	1991->	2		0,9	DP8EA-9	5829	DPR8EA-9	4929
350	SL350,K	350	1969->1973	2		0,8	BR8ES	5422		
350	XL350,K	350	1985->1987	1		0,7	D8EA	2120	DR8EA	7162
350	XLX350	350	1991->	1		0,9	DP8EA-9	5829	DPR8EA-9	4929
350	XR350,R	350	1983->1985	1		0,9	DP8EA-9	5829	DPR8EA-9	4929
350	YRX350FM	350	2000->2006	1		0,9	DPR7EA-9	5129		
360	CB360,G,T	360	1974->	2		0,8	BR8ES	5422		
400	CB400 SUPER 4	400	1989->1990	4		0,9	CR8EH-9	5666		
400	CB400A,F	400	1979->	4		0,7	D8EA	2120	DR8EA	7162
400	CB400N	400	1978->1984	4		0,7	D8EA	2120	DR8EA	7162
400	CB400SS	400	1979->1981	4		0,9	DPR8EA-9	4929		
400	CB400T	400	1980->1981	4		0,7	D8EA	2120	DR8EA	7162
400	CBR 400RR	400	1989->2002	4		0,9	CR8EH-9	5666		
400	CBR400RR	400	2003->	4		0,9	CR8EH-9	5666		
400	CM400A/E	400	1979->1981	2		0,7	D8EA	2120	DR8EA	7162
400	CM400T	400	1980->1981	2		0,7	D8EA	2120	DR8EA	7162
400	CX400,C	400	1979->1981	2		0,7	D8EA	2120	DR8EA	7162
400	NS400,R	400	1985->	3		0,8	B9ES	2611	BR9ES	5722
400	VF400F	400	1985->	4		0,9	DP8EA-9	5829	DPR8EA-9	4929
400	VFR400R	400	1991->	4		0,7	ER9EH	5869		
400	XR400R	400	1996->2004	1		0,8	DPR8Z	4730		
450	CB-450 TR-DX	450	1981->1982	2		0,9	DP8EA-9	5829	DPR8EA-9	4929
450	CB450T HAWK	450	1982->	2		0,7	D8EA	2120	DR8EA	7162
450	CR450	450	2002->	1		1,1	BKR8EIX	2668		
450	CRF450R	450	2002->	1		1,1	IFR8H-11	5068	BKR8E-11	6587
450	CRF450R	450	2003->	1		1,1	IFR9H-11	6588		
450	CRF450R	450	2007->2008	1		1,1	IFR8H-11	5068	BKR8E-11	6587
450	CRF450R	450	2009->	1		0,9	SILMARGA9S	6213		
450	CRF450X	450	2005->2006	1		1,1	IFR8H-11	5068	BKR8E-11	6587
450	CRF450X	450	2007->	1		1,1	IFR8H-11	5068	BKR8E-11	6587
480	CR480R	480	1982->1983	1		0,8	B8ES	2411	BR8ES	5422
500	CB 500 F	500	2013->	2		0,9	CPR8EA-9	2306		
500	CB 500 X	500	2013->	2		0,9	CPR8EA-9	2306		
500	CB500	500	>1975	4		0,7	D7EA	7912	DR7EA	7839
500	CB500T	500	1975->1976	4		0,8	B8ES	2411	BR8ES	5422
500	CB500V	500	1971->1973	4		0,9	CR8EH-9	5666		
500	CBF 500	500	2004->	2		0,9	CR8EH-9	5666		
500	CBR 500R	500	2013->	2		0,9	CPR8EA-9	2306		
500	CR500	500	1993->	1		0,8	B8ES	2411	BR8ES	5422
500	CR500R	500	1984->2001	4		0,8	B8ES	2411	BR8ES	5422



MOTOR CYCLES



Model	Type	Capacity	Year	Cyl	Engine	Gap	Recommended	Stock Code	Alternative	Stock Code
HONDA										
500	CX500T	500	1982>	2		0,9	DP8EA-9	5829	DPR8EA-9	4929
500	CX500,C,D,SPORT	500	1978>1979	2		0,7	D8EA	2120	DR8EA	7162
500	FT500,ASCOT	500	1982>1983	1		0,7	D8EA	2120	DR8EA	7162
500	GL500	500	1981>	2		0,7	D8EA	2120	DR8EA	7162
500	VF500C,F,FI	500	1984>1985	4		0,9	DP8EA-9	5829	DPR8EA-9	4929
500	VT500C,E,FT	500	1983>1988	1		0,9	DP8EA-9	5829	DPR8EA-9	4929
500	XL500R,S	500	1979>1982	1		0,7	D8EA	2120	DR8EA	7162
500	XR500	500	1979>1980	1		0,7	D8EA	2120	DR8EA	7162
500	XR500R	500	1981>	1		0,9	DP8EA-9	5829	DPR8EA-9	4929
550	CB 550 K	550	1977>1978	4		0,8	DR7ES	3123		
550	CBX550F,FI,T	550	1974>1978	4		0,7	D8EA	2120	DR8EA	7162
600	CB600 HORNET	600	2009>	4		0,9	CR9EH-9	7502		
600	CB600F HORNET	600	2001>	4		0,9	CR9EH-9	7502		
600	CB600F/FA HORNET	600	2007>	4		0,9	CR9EH-9	7502		
600	CBF 600 S	600	2008>	4		0,9	CR8EH-9	5666		
600	CBF600S	600	2008>	4		0,9	CR8EH-9	5666		
600	CBR600	600	1987>1990	4		0,9	C9EH-9	2142	CR9EH-9	7502
600	CBR600 FK,FL,FN	600	1987>1988	4		0,9	DPR9EA-9	5329	DPR9EIX-9	5545
600	CBR600F4I	600	2002>2006	4		0,9	IMR9C-9H	6777	CR9EH-9	7502
600	CBR600FX	600	1999>2001	4		0,9	CR8EH-9	5666		
600	CBR600F,FS	600	2001>	4		0,9	CR9EHIX-9	6216	CR9EH-9	7502
600	CBR600RR	600	2003>2004	4		0,9	IMR9C-9H	6777	CR9EH-9	7502
600	CBR600RR	600	2007>	4		0,9	IMR9C-9H	6777	CR9EH-9	7502
600	CBR600RR	600	2008>	4		0,9	IMR9C-9H	6777	CR9EH-9	7502
600	CBR600RR	600	2009>	4		0,9	IMR9C-9H	6777	CR9EH-9	7502
600	CBR600RR HANNSPREE	600	2008>	4		0,9	IMR9C-9H	6777	CR9EH-9	7502
600	FE5600 SILVER WING	600	2001>	4		0,9	CR8EH-9	5666		
600	VT600	600	1988>1993	2		0,9	DPR8EA-9	4929		
600	VT600CD SHADOW VLX	600	1999>2007	4		0,9	DPR8EA-9	4929		
600	VT600CV	600	1988>1993	2		0,9	DPR8EA-9	4929		
600	XL600L	600	1983>1987	1		0,9	DP8EA-9	5829	DPR8EA-9	4929
600	XL600R	600	1983>1987	1		0,9	DP8EA-9	5829	DPR8EA-9	4929
600	XR600R,RM,RP	600	1987>	1		0,9	DP9EA-9	6629	DPR9EA-9	5329
650	CB650C	650	1980>1981	4		0,9	DP8EA-9	5829	DPR8EA-9	4929
650	CB650S,SC,SCF	650	1983>1985	4		0,9	DP8EA-9	5829	DPR8EA-9	4929
650	CX650 C,E,CUSTOM	650	1983>	1		0,9	DP8EA-9	5829	DPR8EA-9	4929
650	FMX650	650	2005>	1		0,9	DPR8EA-9	4929		
650	TRANSALP 650V	650	2004>	1		0,9	DPR8EA-9	4929		
650	XL650RY	650	2000>	2		1,1	BKR8E-11	6587		
650	XR650L	650	1993>2006	1		0,9	DPR8EA-9	4929		
650	XR650R	650	2000>2007	1		0,8	BCPR7E	1272		
650	XRV650	650	1988>	1		0,9	DPR8EA-9	4929		
650	XRV650S	650	1989>1990	1		0,9	DPR9EA-9	5329	DPR9EIX-9	5545
680	TRANSALP680 VT	680	2008>	1		0,9	CPR8EA-9	2306		
700	NC 700 S , X	700	2012>	2		1,1	IFR6G-11K	1314		
700	TRANSALP700	700	2008>	1		0,9	CPR8EA-9	2306		
700	XL700V	700	2008>	1		0,9	CPR8EA-9	2306		
750	SHADOW 750	750	2008>	2		0,9	DPR7EA-9	5129		
750	750RS SHADOW	750	2010>	2		0,9	DPR7EA-9	5129		
750	BLACK SPIRIT 750	750	2010>	2		0,9	DPR7EA-9	5129		
750	CB750C,F,F2,K	750	1980>	4		0,7	D8EA	2120	DR8EA	7162
750	CB750,A,FZ,KZ	750	1980>	4		0,7	D8EA	2120	DR8EA	7162
750	CBX750F,2	750	1984>1986	4		0,9	DP8EA-9	5829	DPR8EA-9	4929
750	NC 750	750	2012>	2		1,1	IFR6G-11K	1314		
750	RVF 750 R,R45	750	1994>1997	4		0,9	CR9EHIX-9	6216	CR9EH-9	7502
750	SHADOW 750	750	2004>	2		0,9	DPR8EA-9	4929		
750	VF750,C,F,S	750	1997>2000	4		0,9	DPR9EA-9	5329	DPR9EIX-9	5545
750	VFR750,FN	750	1988>	4		0,9	DP9EA-9	6629	DPR9EA-9	5329
750	VT750C SHADOW AERO	750	2004>2006	2		0,9	DPR7EA-9	5129		
750	VT750C2 SHADOW	750	2000>	4		0,9	DPR8EA-9	4929		
750	VT750DC BLACK WIDOW	750	2001>	4		0,9	DPR8EA-9	4929		
750	VT750DC SHADOW SPIRIT	750	2006>	2		0,9	DPR7EA-9	5129		
750	XRV750	750	1993>	2		0,9	DPR8EA-9	4929		
750	XRV750ED	750	1993>	2		0,9	DPR8EA-9	4929		
800	VFR 800 VTEC	800	2013>	4		0,9	IMR9B-9H	4888	CR9EH-9	7502
800	VFR800	800	1998>	4		0,8	CR8EIX	4218	CR8E	1275
800	VFR800	800	1998>	4		0,9	CR9EH-9	7502		
800	VFR800F1 02	800	2002>	4		0,9	IMR9C-9H	6777	CR9EH-9	7502
800	VFR800,A INTERCEPTOR	800	2002>2005	4		0,9	IMR9C-9H	6777	CR9EH-9	7502
900	CB900F,F2	900	1979>	4		0,7	D9EA	2420		
900	CBR900	900	2003>	4		0,9	IMR9C-9H	6777	CR9EH-9	7502
900	CBR900RR	900	1996>	4		0,9	CR9EH-9	7502		



MOTOR CYCLES



Model	Type	Capacity	Year	Cyl	Engine	Gap	Recommended	Stock Code	Alternative	Stock Code
HONDA										
900	CBR900RR FIREBLADE	900	2002->	4		0,9	CR9EHIX-9	6216	CR9EH-9	7502
900	CBR900RRY	900	2000->	4		0,9	CR9EHIX-9	6216	CR9EH-9	7502
900	HORNET 900	900	2002->	4		0,9	CR8EH-9	5666		
929	CBR929RR	929	2000->2001	4		0,9	CR9EH-9	7502		
950	CBR954RR	954	2002->2003	4		0,9	IMR9C-9H	6777	CR9EH-9	7502
1000	CB1000R	1000	2008->	4		0,9	IMR9C-9H	6777	CR9EH-9	7502
1000	CB1000R	1000	2008->	4		0,9	IMR9E-9HES	7556	CR9EH-9	7502
1000	CB1000SF	1000	1994->1995	4		0,9	DPR8EA-9	4929		
1000	CBF 1000	1000	2006->	4		0,9	CR8EH-9	5666		
1000	CBF 1000	1000	2009->	4		0,9	CR8EH-9	5666		
1000	CBR1000	1000	1995->2000	4		0,9	DP9EA-9	6629	DPR9EA-9	5329
1000	CBR1000 FIRE BLADE	1000	2007->	4		0,9	IMR9C-9H	6777	CR9EH-9	7502
1000	CBR1000FK,FL	1000	1987->1988	4		0,9	DPR9EA-9	5329	DPR9EIX-9	5545
1000	CBR1000RR	1000	2005->2007	4		0,9	IMR9C-9H	6777	CR9EH-9	7502
1000	CBR1000RR	1000	2010->	4		0,9	IMR9E-9HES	7556	CR9EH-9	7502
1000	CBR1000RR FIREBLADE	1000	2009->	4		0,9	IMR9E-9HES	7556	CR9EH-9	7502
1000	CBR1000RR FIREBLADE	1000	2009->2010	4		0,9	IMR9E-9HES	7556	CR9EH-9	7502
1000	CBR1000RR FIREBLADE	1000	2010->	4		0,9	IMR9E-9HES	7556	CR9EH-9	7502
1000	CBX1000	1000	1978->1982	6		0,7	D8EA	2120	DR8EA	7162
1000	CFR1000	1000	2017->	2		0,9	SILMAR8A9S	90992		
1000	GL1000,LTD	1000	1976->	4		0,7	D8EA	2120	DR8EA	7162
1000	SP2 1000	1000	2003->	4		1,1	IFR9H-11	6588		
1000	VARADERO 1000	1000	2006->	2		0,9	LJR8B-9	4873	DPR8EA-9	4929
1000	VARADERO 1000	1000	2008->	2		0,9	LJR8B-9	4873	DPR8EA-9	4929
1000	VARADERO 1000	1000	2008->	2		0,9	LJR8B-9	4873	DPR8EA-9	4929
1000	VARADERO 1000	1000	2008->	2		0,9	LJR8B-9	4873	DPR8EA-9	4929
1000	VTR1000 SP1,SP2	1000	2003->	2		1,1	FR9BI-11	4709		
1000	VTR1000 SP2	1000	2002->	2		1,1	IFR8H-11	5068	BKR8E-11	6587
1000	VTR1000F FIRESTORM	1000	1997->	2		0,9	DCPR9EIX	2316	DCPR9E	2641
1000	VTR1000SP1	1000	2000->	2		1,1	FR9BI-11	4709		
1000	XL1000	1000	1982->1985	2		0,9	DP8EA-9	5829	DPR8EA-9	4929
1000	XL1000 VARADERO	1000	2003->	2		0,9	LJR8B-9	4873	DPR8EA-9	4929
1000	XL1000V VARADERO	1000	1999->2001	2		0,9	DPR8EA-9	4929		
1000	XLV1000 VARADERO	1000	1999->	2		0,9	DP8EA-9	5829	DPR8EA-9	4929
1100	CB 1100	1100	2013->	4		0,8	LMAR8A-9S	6817		
1100	CB1100F,R	1100	1983->	4		0,7	D8EA	2120	DR8EA	7162
1100	CB1100SF X-11	1100	1999->	4		0,9	CR8EH-9	5666		
1100	CBR1100 XX	1100	2006->2009	4		0,9	CR9EHIX-9	6216	CR9EH-9	7502
1100	CBR1100XV	1100	1995->1996	4		0,9	CR9EHIX-9	6216	CR9EH-9	7502
1100	CBR1100XX BLACKBIRD	1100	1997->	4		0,9	CR9EHIX-9	6216	CR9EH-9	7502
1100	CBR1100XX SUPER BLACKBIRD	1100	2001->	4		0,9	CR9EHIX-9	6216	CR9EH-9	7502
1100	GL1100 ASPENCADE,GOLD WING	1100	1982->1983	4		0,9	DP8EA-9	5829	DPR8EA-9	4929
1100	GL1100 INTERSTATE	1100	1982->1983	4		0,9	DP8EA-9	5829	DPR8EA-9	4929
1100	GL1100,DX	1100	1981->	4		0,7	D8EA	2120	DR8EA	7162
1100	GL1100,DX	1100	1982->	4		0,9	DP8EA-9	5829	DPR8EA-9	4929
1100	ST1100M	1100	1992->2002	4		0,9	CR8EH-9	5666		
1100	VT1100CV	1100	1987->2007	2		0,9	DPR7EA-9	5129		
1100	VT1100C,C2	1100	1987->2007	2		0,9	DPR7EA-9	5129		
1200	GL1200 ASPENCADE,GOLD WING	1200	1984->1987	4		0,9	DP8EA-9	5829	DPR8EA-9	4929
1200	GL1200 INTERSTATE,LIMITED EDITION	1200	1984->1987	4		0,9	DP8EA-9	5829	DPR8EA-9	4929
1200	VFR1200 F	1200	2010->	4		0,9	IMR9C-9H	6777	CR9EH-9	7502
1300	CB1300SF	1300	1987->1991	4		0,9	DPR8EA-9	4929		
1300	ST1300	1300	2003->2009	4		0,9	CR8EH-9	5666		
1300	VT1300 CX	1300	2010->	2		0,8	DCPR6E	3481		
1300	VTX1300 C	1300	2004->2009	4		0,8	DCPR6E	3481		
1300	VTX1300 CX	1300	2010->	4		0,8	DCPR6E	3481		
1300	VTX1300 R	1300	2005->2009	4		0,8	DCPR6E	3481		
1300	VTX1300 S	1300	2003->2007	4		0,8	DCPR6E	3481		
1300	VTX1300 T	1300	2008->2009	4		0,8	DCPR6E	3481		
1400	1400 GTR	1400	2011->	4		0,9	CR9EIA-9	6289	CR9E	6263
1500	GL1500CV	1500	1997->	6		0,9	DPR7EA-9	5129		
1500	GL1500L	1500	1991->1996	6		0,9	DPR7EA-9	5129		
1800	VTX 1800	1800	2001->	6		1,1	IFR6J-11	7658	BKR6E-11	94306
1800	VTX1800	1800	2001->	6		1,1	IFR6J-11	7658	BKR6E-11	94306
1800	VTX1800	1800	2003->	6		1,1	BKR6E-11	94306		
1880	GL1880	1880	2001->	6		0,8	BKR6E	97737		

HUSQVARNA										
50	CR 50	50	2011->	1		0,6	BR8ECM	3035		
50	CR 50 MINI MOTARD	50	2010->	1		0,8	BR9ES	5722		
50	HUSKY BOY BASIC 50	50	2001->	1		0,8	B8HS	5510	BR8HS	4322
50	HUSKY BOY JNR 50	50	2001->	1		0,6	B6HS	4510	BR6HS	3922



MOTOR CYCLES



Model	Type	Capacity	Year	Cyl	Engine	Gap	Recommended	Stock Code	Alternative	Stock Code
HUSQVARNA										
50	HUSKY BOY RACING	50	2001->	1		0,8	B6HS	4510	BR6HS	3922
50	HUSKY BOY SNR 50	50	2001->	1		0,6	B6HS	4510	BR6HS	3922
50	SM 50	50	2011->	1		0,6	BR8ECM	3035		
50	TC 50	50	2017->	1		0,7	LR8B	6208		
50	TC 50 MINI	50	2018->	1		0,8	LR8B	6208		
50	WRS 50	50	1999->	1		0,8	B9ES	2611	BR9ES	5722
65	CR 65 MINI CROSS	65	2011->	1		0,6	BR8ECM	3035		
65	TC 65	65	2017->	1		0,7	LR8B	6208		
85	TC 85	85	2014->	1		0,7	BR9ECMIX	2707		
125	CR 125	125	1990->1997	1		0,8	BR9EG	3230	BR9ES	5722
125	CR 125	125	2013->	1		0,8	BR9EG	3230	BR9ES	5722
125	MOTOCROSS CR125	125	1990->1997	1		0,8	B9ES	2611	BR9ES	5722
125	SM 125 S	125	1998->2003	1		0,8	BR9EG	3230	BR9ES	5722
125	SM S 125	125	2011->	1		0,8	CR8E	1275		
125	SMS 4	125	2011->	1		0,8	CR8E	1275		
125	TE 125	125	2011->	1		0,8	CR8E	1275		
125	TE 125 4T	125	2011->	1		0,8	CR8E	1275		
125	WMX 125	125	1990->1992	1		0,8	B9ES	2611	BR9ES	5722
125	WR 125	125	1998->2012	1		0,8	BR9EG	3230	BR9ES	5722
125	WR 125	125	2013->	1		0,8	BR9EG	3230	BR9ES	5722
125	WR 125	125	1998->2004	1		0,8	BR9EG	3230	BR9ES	5722
125	WRE 125	125	1998->2001	1		0,8	B9EG	3530	BR9EG	3230
250	250 EXC	250	2018->	1		1,3	ZGR7GI-13G	96760		
250	FC 250	250	2014->	1		0,8	LMAR9AI-8	97225		
250	FE 250	250	2014->	1		0,8	LMAR9AI-8	97225		
250	MOTOCROSS RT,CR250	250	2002->2004	1		0,8	B8ES	2411	BR8ES	5422
250	SPORTSMAN ENDURO 250	250	->1971	1		0,8	B9ES	2611	BR9ES	5722
250	TC 250	250	2002->2005	1		0,8	CR8E	1275		
250	TC 250	250	2010->	1		0,8	CR9EB	6955		
250	TC 250 R	250	2010->	1		0,8	CR9EB	6955		
250	TE 250	250	2002->2005	1		0,8	CR8E	1275		
250	TE 250 R	250	2010->	1		0,8	CR9EB	6955		
250	WR 250	250	2002->2005	1		0,8	BR8EG	3130	BR8ES	5422
250	WR 250	250	2013->	1		0,6	BR8EG	3130		
300	300 EXC	300	2018->	1		1,3	ZGR7GI-13G	96760		
300	TX300	300	2017->	1		0,6	BR7ES	5122		
300	WR 300	300	2009->	1		0,8	BR8EG	3130	BR8ES	5422
310	TE 310	310	2009->	1		0,8	CR8E	1275		
350	FE350	350	2017->	1		0,8	LMAR9AI-8	97225		
360	MOTOCROSS RT360	360	1992->1993	1		0,8	B8ES	2411	BR8ES	5422
360	SPORTSMAN ENDURO 360	360	->1971	1		0,8	B8ES	2411	BR8ES	5422
400	MOTOCROSS 400	400	->1971	1		0,8	B8ES	2411	BR8ES	5422
400	TE400	400	2001->	1		0,7	C7E	5096	CR7E	4578
450	TC 450	449	2011->	1		0,8	CR9EK	4548		
450	TE 450	449	2011->	1		0,8	CR9EK	4548		
450	MOTOCROSS 450	450	2001->2002	1		0,8	B8ES	2411	BR8ES	5422
450	SM 450R	450	2003->	1		0,8	CR8E	1275		
450	SMR 450	450	2004->	1		0,8	CR8E	1275		
450	TC 450	450	2002->2005	1		0,8	CR8E	1275		
450	TE 450	450	2002->2005	1		0,8	CR8E	1275		
460	CR 460	460	1987->	1		0,8	B8ES	2411	BR8ES	5422
500	TC 500	500	1986->	1		0,7	D8EA	2120	DR8EA	7162
510	CROSS COUNTRY 510	510	1990->	1		0,7	C7E	5096	CR7E	4578
510	MOTOCROSS 510	510	1990->	1		0,7	C7E	5096	CR7E	4578
510	TC 510	510	2004->2005	1		0,8	CR8E	1275		
510	TE 510	510	1987->1990	1		0,7	D8EA	2120	DR8EA	7162
510	TE 510	510	2004->2005	1		0,8	CR8E	1275		
511	SMR 511	511	2011->	1		0,8	CR9EK	4548		
511	TE 511	511	2011->	1		0,8	CR9EK	4548		
570	NOX570	570	2001->	1		0,7	C7E	5096	CR7E	4578
570	SM570R	570	2004->	1		0,8	C8E	7471	CR8E	1275
570	TC,TE570	570	2001->	1		0,7	C7E	5096	CR7E	4578
610	SM610	610	2003->	1		0,7	C7E	5096	CR7E	4578
610	SM610	610	2006->	1		0,8	CPR8EA-9	2306		
610	SM610S	610	2003->	1		0,8	C8E	7471	CR8E	1275
630	SMR 630	630	2004->	1		0,8	R0045Q-10	4216		
630	TE 630	630	2010->	1		0,8	CR8E	1275		
701	701 ENDURO	690	2017->	1		1	LKAR9BI9+ LMAR7DI-10			
701	701 SUPERMOTARD	690	2017->	1		1	LKAR9BI9+ LMAR7DI-10			



MOTOR CYCLES



Model	Type	Capacity	Year	Cyl	Engine	Gap	Recommended	Stock Code	Alternative	Stock Code
-------	------	----------	------	-----	--------	-----	-------------	------------	-------------	------------

HYOSUNG										
125	GA 125	125	2000->	1		0,9	CR8EH-9	5666	C8EH-9	7473
125	GPS 125	125	2001->	1		0,7	DR8EA	7162		
125	GT125	125	2006->	1		0,9	CR8EH-9	5666	C8EH-9	7473
125	GT125R TTC	125	2007->	1		0,8	CR8E	1275		
125	GV125 M CRUISER	125	2007->	1		0,8	CR8E	1275		
125	RX125	125	2000->	1		0,9	CR8EH-9	5666	C8EH-9	7473
250	GT250	250	2005->	1		0,8	CR8E	1275		
650	GT650I R	650	2007->	2		0,8	CR8E	1275		
650	GT650R	650	2006->	2		0,8	CR8E	1275		
650	GT650S	650	2006->	2		0,8	CR8E	1275		
650	GV650	650	2006->	2		0,8	CR8E	1275		
650	GV650I SPORT CRUISER	650	2007->	2		0,8	CR8E	1275		

ITAL JET										
50	MINI BAMBINO JUNIOR CROSS 50	50	1982->1984	1		0,6	B6HS	4510	BR6HS	3922
50	SCIMITAR KIT KAT 50	50	->1982	1		0,6	B6HS	4510	BR6HS	3922
50	TEENAGER JUNIOR CROSS 4M 50	50	->1982	1		0,6	B6HS	4510	BR6HS	3922
125	BUCCANEER 125	125	->1983	1		0,7	B7HS	5110	BR7HS	4122
125	KANGAROO COYOTE 125	125	1981->1982	1		0,8	B8HS	5510	BR8HS	4322
180	DRAGSTER 180	180	2000->	1		0,8	BR9ES	5722		
250	MILLENNIUM 250	250	2000->	1		0,7	DR8EA	7162		

JAWA										
50	STAR 50S,C	50	1986->1987	1		0,6	B6HS	4510	BR6HS	3922
125	BETKA 125	125	2006->	1		0,7	C7HSA	4629	CR7HSA	4549
125	DANDY 125	125	2000->	1		0,7	DR8EA	7162		
350	CHOPPER 350C,H	350	1987->	2		0,7	B7HS	5110	BR7HS	4122
350	DELIVERY 350C,M	350	1979->1981	2		0,7	B7HS	5110	BR7HS	4122
350	ECONOMY 1 350R,D	350	1982->1984	2		0,8	B8HS	5510	BR8HS	4322
350	SPORT 350R,D	350	->1984	2		0,7	B7HS	5110	BR7HS	4122
350	STYLE 350R,D	350	1987->	2		0,8	B8HS	5510	BR8HS	4322
350	TRAMP 350,F	350	->1981	2		0,7	B7HS	5110	BR7HS	4122
350	TRICYCLE 350 3,W	350	1993->	2		0,7	B7HS	5110	BR7HS	4122
500	500R	500	1986->1990	2		0,8	DR8EIX	6681	DR8EA	7162
500	SPECIAL 500	500	1990->1993	2		0,8	DR8EIX	6681	DR8EA	7162
500	SPEEDWAY 500DT	500	1985->1986	2		0,8	B9EG	3530	BR9EG	3230
650	DAKAR 650	650	2006->	2		0,7	DR8EA	7162		

JIALING										
50	CJ 50F, K	50	1990->1992	1		0,7	BPR6HS	7022		
50	LX 50	50	1987->1990	1		0,7	BPR6HS	7022		
50	QM 50	50	->1987	1		0,7	BPR4HS	7823		
50	TA 50	50	1987->1990	1		0,7	BPR6HS	7022		
90	K 90	90	->1984	1		0,7	BP7HS	5111		
100	K 100	100	1984->1986	1		0,7	BP7HS	5111		
100	QM 100	100	1986->1987	1		0,7	BP7HS	5111		
125	SANYANG DUKE 125	125	1989->1999	1		0,9	DPR7EA-9	5129		
125	SANYANG WOLF 125	125	1986->1989	1		0,7	DR8ESL	2923		

KAWASAKI										
50	AE50	50	1983->1997	1		0,8	B8ES	2411	BR8ES	5422
50	AR50	50	1982->1982	1		0,8	B8ES	2411	BR8ES	5422
50	STAR 50	50	1969->1970	1		0,7	B6HS	4510	BR6HS	3922
60	KX60	60	->1992	1		0,8	B9ES	2611	BR9ES	5722
65	KX65	65	2000->	1		0,8	BR10EG	3830		
65	KX65 ACF	65	2011->	1		0,8	BR10EG	3830		
65	KX65 AEF	65	2014->	1		0,8	BR10EG	3830		
80	AR80	80	1981->1982	1		0,8	BPR7ES	95164		
80	KDX80	80	1989->1992	1		0,8	B8ES	2411	BR8ES	5422
80	KX80	80	1981->1982	1		0,8	B9EG	3530	BR9EG	3230
85	KX85	85	2001->	1		0,8	R7436-10			
85	KX85 CEF	85	2014->	1		0,8	R7436-10			
90	KH90	90	1971->	1		0,8	B8ES	2411	BR8ES	5422
90	STAR 90	90	1969->1970	1		0,7	BR6HS	3922		
100	KC 100	100	1979->1986	1		0,8	B8ES	2411	BR8ES	5422
100	KE 100	100	1977->1999	1		0,8	B8ES	2411	BR8ES	5422
100	KH 100	100	1977->1981	1		0,8	B8ES	2411	BR8ES	5422
100	KV 100	100	1982->	1		0,8	B8ES	2411	BR8ES	5422
100	KV 100	100	1981->	1		0,7	B7HS	5110	BR7HS	4122
100	KX 100	100	1992->	1		0,8	B9ES	2611	BR9ES	5722



MOTOR CYCLES



Model	Type	Capacity	Year	Cyl	Engine	Gap	Recommended	Stock Code	Alternative	Stock Code
KAWASAKI						KAWASAKI				
100	KX100DCF	100	2001->2009	1		0,8	R7436-10			
110	KH110	110	1983->1995	1		0,8	B8ES	2411	BR8ES	5422
110	KLT110	110	1979->1983	1		0,7	C6HSA	3228	CR6HSA	2983
110	KLX110	110	2002->2010	1		0,7	CR6HSA	2983		
125	125	125	1986->1989	1		0,8	C8HSA	6821		
125	AR125	125	2001->	1		0,8	BR8ES	5422		
125	KE125	125	1976->1979	1		0,8	B9ES	2611	BR9ES	5722
125	KH125	125	1993->	1		0,8	B8ES	2411	BR8ES	5422
125	KMX125	125	1986->2000	1		0,8	B8ES	2411	BR8ES	5422
125	KX125	125	2003->	1		0,8	B9EG	3530	BR9EG	3230
125	KX125	125	2003->	1		0,8	BR9ES	5722		
125	KX125	125	2006->	1		0,8	BR9ECMIX	2707		
150	KRR ZX 150	150	2006->	1		0,8	B9ES	2611	BR9ES	5722
175	KE175	175	1979->	1		0,8	B7ES	1111	BR7ES	5122
175	KV175	175	1976->1978	1		0,8	B7ES	1111	BR7ES	5122
200	KDX200 (EI)	200	1995->1996	1		0,8	B9ES	2611	BR9ES	5722
200	KMX200	200	1990->1992	1		0,8	B8ES	2411	BR8ES	5422
200	Z200	200	1978->	1		0,8	B7ES	1111	BR7ES	5122
250	ESTRELLA	250	2014->	1		0,8	DR9EIX	4772	D9EA	2420
250	EX250JCF	250	2011->	1		0,8	CR8E	1275		
250	KDX250	250	1980->1983	1		0,8	B9ES	2611	BR9ES	5722
250	KL250,B	250	1976->	1		0,8	B9HS	5810	BR9HS	4522
250	KL250	250	1978->1982	1		0,8	B8ES	2411	BR8ES	5422
250	KLR250	250	1979->1980	1		0,8	B9ES	2611	BR9ES	5722
250	KLX250	250	1979->1980	1		0,8	B7ES	1111	BR7ES	5122
250	KLX250	250	2011->	1		0,8	CR8E	1275		
250	KR250	250	1975->1978	1		0,8	B9ES	2611	BR9ES	5722
250	KV250	250	1985->1987	1		0,8	B8ES	2411	BR8ES	5422
250	KX 250	250	1978->1981	1		0,8	B9ES	2611	BR9ES	5722
250	KX 250	250	2005->	1		0,8	BR8ECMIX	3520		
250	KX250 ZEF	250	2014->	1		0,8	CPR8EB-9	6607		
250	KX250F	250	2004->	1		0,8	CR8E	1275		
250	KX250F	250	2004->	1		0,8	CR8E	1275		
250	KX250R	250	2005->	1		0,8	BR8ECM	3035		
250	KX250R	250	2007->	1		0,8	BR8ECMIX	3520		
250	KX250YCF	250	2011->	1		0,9	CPR9EA-9	2308		
250	KXT250	250	1990->1991	1		0,8	B8ES	2411	BR8ES	5422
250	KZ250C	250	1983->	1		0,8	B8ES	2411	BR8ES	5422
250	NINJA 250 R	250	2011->	1		0,8	CR8E	1275		
250	Z250	250	1971->1972	1		0,8	B8ES	2411	BR8ES	5422
250	Z250	250	1998->	1		0,8	BR7ES	5122		
300	EX300 AEF	300	2014->	1		0,8	CR8E	1275		
300	KAF300 MULE 550,520	300	2000->	1		0,8	BPR5ES	94084		
300	KEF300A	300	2000->	1		0,7	DR8EA	7162		
300	KLF300	300	1988->2006	1		0,8	B8ES	2411	BR8ES	5422
300	KVF300	300	1998->2001	1		0,7	DR8EA	7162		
400	GPZ400	400	1985->	2		0,9	DP9EA-9	6629	DPR9EA-9	5329
400	KH400/A	400	1985->1991	3		0,8	B8HS	5510	BR8HS	4322
400	KVF400 4X4	400	2000->	1		0,9	DPR8EA-9	4929		
400	KX400,A	400	1975->1976	1		0,8	B9ES	2611	BR9ES	5722
400	KXF400A	400	2003->	4		0,8	CR8E	1275		
400	KZ400,B,C,D,G,H	400	1975->1976	4		0,8	B7ES	1111	BR7ES	5122
400	KZ400,E,J,K	400	1982->	2		0,7	D8EA	2120	DR8EA	7162
400	Z400F-II	400	1984->	4		0,9	DP9EA-9	6629	DPR9EA-9	5329
400	Z400F	400	1984->	4		0,9	DP9EA-9	6629	DPR9EA-9	5329
400	Z400GP	400	1982->1983	2		0,7	D7EA	7912	DR7EA	7839
400	Z400R	400	1975->1980	2		0,8	B7ES	1111	BR7ES	5122
400	ZX400	400	1993->	4		0,7	D9EA	2420		
400	ZX400C	400	1993->	4		0,7	DR9EIX	4772	D9EA	2420
400	ZXR400L	400	1998->	4		0,8	CR9EK	4548		
400	ZZR400	400	2002->	4		0,8	CR9EK	4548		
420	DX420	420	1981->	1		0,8	B8ES	2411	BR8ES	5422
420	KX420A	420	1980->1981	1		0,8	B9ES	2611	BR9ES	5722
440	Z440LTD	440	1980->1985	2		0,8	B7ES	1111	BR7ES	5122
450	DX450	450	1979->1982	1		0,8	B8ES	2411	BR8ES	5422
450	KLX 450R	450	2008->	1		0,9	CPR8EB-9	6607		
450	KLX450R	450	2008->	1		0,9	CPR8EB-9	6607		
450	KLX450R	450	2010->	1		0,9	CPR8EB-9	6607		
450	KSF450BCS	450	2011->	1		0,9	CPR8EB-9	6607		
450	KX450	450	1974->	1		0,8	B9ES	2611	BR9ES	5722
450	KX450 FEF	450	2014->	1		0,8	CPR8EB-9	6607		
450	KX450F	450	2006->	1		0,9	CPR8EB-9	6607		
450	KX450F	450	2006->	1		0,9	CPR8EB-9	6607		

MOTORCYCLES



MOTOR CYCLES



Model	Type	Capacity	Year	Cyl	Engine	Gap	Recommended	Stock Code	Alternative	Stock Code
KAWASAKI										
450	KX450FCF	450	2011->	1		0,9	CPR8EB-9	6607		
450	LTD450 LIQUID COOLED	450	1982->1989	4		0,7	D8EA	2120	DR8EA	7162
500	EN500	500	1990->	2		0,7	DR9EIX	4772	D9EA	2420
500	EX500	500	1990->	2		0,7	D9EA	2420		
500	EX500D NINJA	500	1997->2006	2		0,7	DR9EIX	4772	D9EA	2420
500	GPZ500R	500	1994->2000	4		0,7	D8EA	2120	DR8EA	7162
500	KDX-500	500	1991->1992	1		0,8	B9ES	2611	BR9ES	5722
500	KH500	500	1976->	3		1	B9HS-10	3626	BR9HS-10	4551
500	KLE500	500	1990->2005	2		0,7	DR9EIX	4772	D9EA	2420
500	KLE500	500	2003->2004	2		0,7	DR8EA	7162		
500	KX500	500	1993->	1		0,8	B8ES	2411	BR8ES	5422
550	GPZ550	550	1982->	4		0,9	DP9EA-9	6629	DPR9EA-9	5329
550	GT550	550	1983->2001	4		0,7	DR8EA	7162		
550	KZ550	550	1980->1983	4		0,7	D8EA	2120	DR8EA	7162
550	Z550F	550	1982->1985	4		0,7	D8EA	2120	DR8EA	7162
550	Z550GT	550	1983->2001	4		0,7	D8EA	2120	DR8EA	7162
550	Z550LTD	550	1981->1983	4		0,7	D8EA	2120	DR8EA	7162
550	ZR550C	550	1990->1991	4		0,7	DR9EIX	4772	D9EA	2420
600	600R NINJA	600	1992->2000	4		0,7	D9EA	2420		
600	GPZ600R	600	1992->1998	4		0,7	D9EA	2420		
600	KLR600	600	->1984	2		0,7	D8EA	2120	DR8EA	7162
600	KLR600B	600	1985->	2		0,9	DP8EA-9	5829	DPR8EA-9	4929
600	ZX-6R NINJA 600	600	2000->	4		0,8	CR9E	6263		
600	ZX600 REF	600	2014->	4		0,8	CR9E	6263		
600	ZX600RCF	600	2011->	4		0,8	CR9E	6263		
600	ZX600RR NINJA	600	2003->2006	4		0,8	CR9E	6263		
600	ZX6R NINJA 600	600	2003->	4		0,8	CR9E	6263		
600	ZX6RR 600	600	2004->	4		0,8	CR9E	6263		
600	ZZR600	600	2001->	4		0,8	CR9E	6263		
600	ZZR600 NINJA	600	2002->2006	4		0,8	CR9E	6263		
636	ZX636 EEF	636	2014->	4		0,8	CR9E	6263		
650	ER-6F,N 650	650	2006->2008	2		0,9	CR9EIA-9	6289	CR9E	6263
650	ER-6N	650	2011->	2		0,9	CR9EIA-9	6289	CR9E	6263
650	ER650ECF	650	2011->	2		0,9	CR9EIA-9	6289	CR9E	6263
650	ER6F 650	650	2006->	2		0,9	CR9EIA-9	6289	CR9E	6263
650	ER6N 650	650	2006->	2		0,9	CR9EIA-9	6289	CR9E	6263
650	EX650-A NINJA	650	2006->	1		0,9	DPR8EA-9	4929		
650	KL650ECF	650	2011->	1		0,9	DPR8EA-9	4929		
650	KL650DCF	650	2011->	1		0,9	CR9EIA-9	6289	CR9E	6263
650	KLR650	650	1995->	1		0,9	DPR8EA-9	4929		
650	KLR650-A	650	1997->2006	1		0,9	DPR8EA-9	4929		
650	KLR650 EEF	650	2014->	1		0,9	DPR8EA-9	4929		
650	KVF650 V TWIN	650	2001->	2		0,8	CR7E	4578		
650	VERSYS 650	650	2006->	2		0,9	CR9EIA-9	6289	CR9E	6263
650	VERSYS 650	650	2010->	2		0,9	CR9EIA-9	6289	CR9E	6263
650	Z650	650	1977->1979	4		0,8	B7ES	1111	BR7ES	5122
650	Z650	650	1985->1986	4		0,8	BR7ES	5122		
650	Z650	650	1986->1992	4		0,8	BR7ES	5122		
650	Z650 F-B	650	1982->1984	4		0,8	B8ES	2411	BR8ES	5422
750	750 TURBO	750	1982->	4		0,8	B9ES	2611	BR9ES	5722
750	750R NINJA	750	1987->1990	4		0,7	D8EA	2120	DR8EA	7162
750	GPX750R	750	1987->	4		0,7	D9EA	2420		
750	GPZ750	750	1982->	4		0,8	B9ES	2611	BR9ES	5722
750	GPZ750R	750	1982->1983	4		0,7	D8EA	2120	DR8EA	7162
750	GT750	750	1982->1987	4		0,8	B8ES	2411	BR8ES	5422
750	KZ750 TWIN	750	1976->1979	2		0,5	B6ES	7310		
750	KZX750	750	1985->1989	4		0,8	B9ES	2611	BR9ES	5722
750	LTD750	750	1985->	4		0,8	B8ES	2411	BR8ES	5422
750	Z750	750	2004->	4		0,8	CR9EK	4548		
750	Z750LTD	750	1980->1985	4		0,8	B8ES	2411	BR8ES	5422
750	Z750LTD TWIN	750	1982->1983	2		0,5	B6ES	7310		
750	ZEPHYR ZR750	750	1991->2000	4		0,7	DR8EA	7162		
750	ZR-7S 750	750	2001->	4		0,7	DR9EIX	4772	D9EA	2420
750	ZR750H	750	2001->2005	4		0,7	DR9EIX	4772	D9EA	2420
750	ZR750MCF	750	2011->	4		0,8	CR9EK	4548		
750	ZR750R	750	2005->	4		0,8	CR9EK	4548		
750	ZR750S	750	2005->	4		0,8	CR9EK	4548		
750	ZX750F	750	1987->1990	4		0,8	B9ES	2611	BR9ES	5722
800	VN800A,CLASSIC	800	2001->	2		0,8	CR7E	4578		
900	900 NINJA	900	1990->	4		0,7	D8EA	2120	DR8EA	7162
900	GPZ900R	900	1991->1993	4		0,7	D9EA	2420		
900	VN900	900	2009->	4		0,9	CPR8EA-9	2306		
900	VN900 CLASSIC	900	2006->	4		0,9	CPR8EA-9	2306		

MOTORCYCLES



MOTOR CYCLES



Model	Type	Capacity	Year	Cyl	Engine	Gap	Recommended	Stock Code	Alternative	Stock Code
KAWASAKI										
900	ZX-9R NINJA 900	900	1994->	4		0,8	CR9EK	4548		
1000	1000R NINJA	1000	1991->1997	4		0,7	D8EA	2120	DR8EA	7162
1000	GPZ1000	1000	1982->	4		0,7	D8EA	2120	DR8EA	7162
1000	GPZ1000R	1000	1985->1989	4		0,7	D8EA	2120	DR8EA	7162
1000	GPZ1000RX	1000	1982->1985	4		0,7	D8EA	2120	DR8EA	7162
1000	H2	1000	2015->	4		0,9	SILMAR9B-9	95399		
1000	KLV1000	1000	2004->	4		0,8	CR8EK	3478		
1000	KLZ1000 AEF	1000	2014->	4		0,8	CR9EIA-9	6289	CR9E	6263
1000	KZ1000J	1000	1993->	4		0,8	B8ES	2411	BR8ES	5422
1000	Z1 1000	1000	1985->1989	4		0,8	B8ES	2411	BR8ES	5422
1000	Z1000	1000	2003->2006	4		0,8	CR9EK	4548		
1000	Z1000	1000	2010->	4		0,9	CR9EIA-9	6289	CR9E	6263
1000	Z1000GTR	1000	1986->1994	4		0,7	D8EA	2120	DR8EA	7162
1000	Z1000LTD	1000	1981->1984	4		0,7	D8EA	2120	DR8EA	7162
1000	Z1000RX	1000	1981->1984	4		0,7	D8EA	2120	DR8EA	7162
1000	ZG1000	1000	1986->	4		0,7	D9EA	2420		
1000	ZR1000ECF	1000	2011->	4		0,9	CR9EIA-9	6289	CR9E	6263
1000	ZX-10	1000	1999->2001	4		0,8	C9E	7499	CR9E	6263
1000	ZX-10R	1000	2004->2007	4		0,9	CR9EIA-9	6289	CR9E	6263
1000	ZX-10R NINJA	1000	2006->	4		0,9	CR9EIA-9	6289	CR9E	6263
1000	ZX 10 R NINJA	1000	2016->	4		0,9	SILMAR9B-9	95399		
1000	ZX1000JCF	1000	2011->	4		0,9	CR9EIA-9	6289	CR9E	6263
1000	ZX10R	1000	2010->	4		0,9	CR9EIA-9	6289	CR9E	6263
1000	ZX10R NINJA	1000	2004->	4		0,9	CR9EIA-9	6289	CR9E	6263
1100	GPZ1100	1100	1995->	4		0,8	B8ES	2411	BR8ES	5422
1100	GPZ1100_ABS	1100	1997->	4		0,8	CR9EK	4548		
1100	LTD 1100	1100	1985->1987	4		0,8	B8ES	2411	BR8ES	5422
1100	Z1100JR	1100	1981->1983	4		0,6	B10ES	7928		
1100	ZEPHYR ZR1100A	1100	1996->1997	4		0,8	CR9E	6263		
1100	ZRX1100	1100	1997->2000	4		0,8	CR9EK	4548		
1100	ZX1100 EDDIE LAWSON	1100	1983->1988	4		0,8	B8ES	2411	BR8ES	5422
1100	ZZR1100	1100	1997->	4		0,8	CR9E	6263		
1200	VOYAGER-XII 1200	1200	1993->	4		0,9	DP8EA-9	5829	DPR8EA-9	4929
1200	ZRX1200R,S	1200	2001->	4		0,8	CR9EK	4548		
1200	ZX-12R NINJA	1200	2001->	4		0,7	CR9EKPA	7785	CR9E	6263
1200	ZZR1200	1200	2002->	4		0,8	CR9E	6263		
1300	KZ1300A	1300	1979->1982	6		0,8	B8ES	2411	BR8ES	5422
1300	VOYAGER 1300	1300	1983->1988	6		0,8	BPR6ES	96989		
1300	Z1300	1300	1978->1979	6		0,8	BPR6ES	96989		
1400	1400 GTR	1400	2011->	4		0,9	CR9EIA-9	6289	CR9E	6263
1400	GTR 1400	1400	2007->	4		0,9	CR9EIA-9	6289	CR9E	6263
1400	VULCAN 1400	1400	2008->	4		1,1	ILZKAR7B11	1654	LZKAR7A	6799
1400	ZG1400 CEF	1400	2014->	4		0,9	CR9EIA-9	6289	CR9E	6263
1400	ZG1400CCF	1400	2011->	4		0,9	CR9EIA-9	6289	CR9E	6263
1400	ZX14	1400	2006->	4		0,9	CR9EIA-9	6289	CR9E	6263
1400	ZZR1400	1400	2006->	4		0,9	CR9EIA-9	6289	CR9E	6263
1500	JT1500HCF	1500	2011->	4		0,8	PMR9B	4717	CPR9EA-9	2308
1500	VN1500	1500	1999->	2		0,9	DPR7EA-9	5129		
1500	VN1500 DRIFTER	1500	1999->	2		0,9	DPR5EA-9	2887		
1500	VNF1500F CLASSIC	1500	1998->	2		0,9	DPR5EA-9	2887		
1600	VN1600	1600	2005->	2		0,9	DR7EA	7839		
1700	VN1700 AEF	1700	2014->	4		1,1	ILZKAR7B11	1654	LZKAR7A	6799
1700	VULCAN VOYAGER	1700	2011->	2		1,1	ILZKAR7B11	1654	LZKAR7A	6799
2000	VN2000	2053	2004->	2		1,1	IZFR6F-11	4095	ZFR6F-11	93208

KAZUMA										
50	MEERKAT 50	50	2011->	1		0,8	C7HSA	4629	CR7HSA	4549
50	WOMBAT 50	50	2011->	1		0,8	C7HSA	4629	CR7HSA	4549
90	MEERKAT 90	90	2011->	1		0,8	C7HSA	4629	CR7HSA	4549
110	BABY FALCON 110	110	2011->	1		0,8	C7HSA	4629	CR7HSA	4549
110	COYOTE 110	110	2011->	1		0,8	C7HSA	4629	CR7HSA	4549
110	FALCON 110 MKI	110	2011->	1		0,8	C7HSA	4629	CR7HSA	4549
110	FALCON MKII 110	110	2011->	1		0,8	C7HSA	4629	CR7HSA	4549
110	VIPER 110	110	2011->	1		0,8	C7HSA	4629	CR7HSA	4549
125	CHEETAH 125	125	2011->	1		0,8	C7HSA	4629	CR7HSA	4549
125	EAGLE 125	125	2011->	1		0,8	C7HSA	4629	CR7HSA	4549
125	SPRINGBOK 125	125	2011->	1		0,8	C7HSA	4629	CR7HSA	4549
150	COYOTE 150	150	2011->	1		0,8	C7HSA	4629	CR7HSA	4549
150	DINGO 150	150	2011->	1		0,8	D8EA	2120	DR8EA	7162
150	FALCON 150	150	2011->	1		0,8	C7HSA	4629	CR7HSA	4549
150	JAGUAR 150	150	2011->	1		0,8	C7HSA	4629	CR7HSA	4549
150	SPRINGBOK 150	150	2011->	1		0,8	C7HSA	4629	CR7HSA	4549



MOTOR CYCLES



Model	Type	Capacity	Year	Cyl	Engine	Gap	Recommended	Stock Code	Alternative	Stock Code
KAZUMA										
200	CHEETAH 200	200	2011->	1		0,8	D8EA	2120	DR8EA	7162
250	ADULT FALCON 250	250	2011->	1		0,8	D8EA	2120	DR8EA	7162
250	COUGAR 250	250	2011->	1		0,8	D8EA	2120	DR8EA	7162
250	DINGO 250	250	2011->	1		0,8	D8EA	2120	DR8EA	7162
250	FALCON 250	250	2011->	1		0,8	D8EA	2120	DR8EA	7162
500	JAGUAR 500 DELUXE	500	2011->	2		0,8	BKR6E	97737		
500	JAGUAR 500 REGULAR	500	2011->	2		0,8	BKR6E	97737		
800	MAMMOTH 800	800	2011->	4		0,8	BP4HS	3611	BPR4HS	7823
KTM										
50	SX 50	50	2008->	1		0,8	CR8HIX	7669	CR8HSA	2086
50	SX 50	50	2008->	1		0,8	LR8A	6199		
50	SX 50	50	2010->	1		0,8	LR8B	6208		
50	SX PRO JNR 50	50	1999->1999	1		0,8	B8HS	5510	BR8HS	4322
50	SX PRO JNR 50	50	2000->2002	1		0,8	BR8HS	4322		
50	SX PRO JNR 50	50	2003->2005	1		0,8	BR8ECM	3035		
50	SX PRO SENIOR 50	50	2002->	1		0,8	BR10EG	3830		
65	SX 65	65	2003->2009	1		0,8	BR8ECM	3035		
65	SX 65	65	2008->	1		0,8	LR8B	6208		
65	SX 65	65	2009->	1		0,8	LR8B	6208		
80	CHOPPER 80	80	1986->	1		0,8	B9HS	5810	BR9HS	4522
85	SX 85	85	2006->2007	1		0,8	BR10ECMIX	3006		
85	SX17/14, 19/16	85	2010->	1		0,8	BR9ECMIX	2707		
100	GS,MC 100	100	1981->1982	1		0,8	B9HS	5810	BR9HS	4522
125	125 DUKE	125	2015->	1		0,9	LKAR8BI-9	1553		
125	COMT GP RS 125	125	1977->	1		0,8	B8HS	5510	BR8HS	4322
125	EXC 125	125	2000->	1		0,8	BR9EG	3230	BR9ES	5722
125	EXC SIX DAYS 125	125	2010->	1		0,8	BR9ECMIX	2707		
125	GS125 12.7MM REACH	125	1985->	1		0,8	B8HS	5510	BR8HS	4322
125	GS127 19.0MM REACH	125	1979->	1		0,8	B9ES	2611	BR9ES	5722
125	LC 125	125	2000->	1		0,8	B9ES	2611	BR9ES	5722
125	MC125 12.7MM REACH	125	1979->	1		0,8	B8HS	5510	BR8HS	4322
125	MC125 19.0MM REACH	125	1982->1984	1		0,8	B9ES	2611	BR9ES	5722
125	MX,ENDURO 125	125	1984->1986	1		0,6	B10ES	7928		
125	SUPERMOTO 125	125	2001->	1		0,8	BR8HS	4322		
125	SX 125	125	2001->	1		0,8	BR9EG	3230	BR9ES	5722
150	SX,XC 150	150	2010->	1		0,8	BR9ECMIX	2707		
175	GS,MC 175	175	1985->	1		0,8	B8HS	5510	BR8HS	4322
200	200 DUKE	200	2015->	1		0,9	LKAR8BI-9	1553		
200	EXC 200	200	1998->	1		0,8	BR8EG	3130		
200	EXC,XC-W 200	200	2010->	1		0,8	BR8EG	3130		
200	SX 200	200	2003->	1		0,8	BR9EIX	3981	BR9ES	5722
200	XC 200	200	2007->2009	1		0,8	BR8EIX	5044	BR8ES	5422
250	250 EXC	250	2018->	1		1,3	ZGR7GI-13G	96760		
250	250 SX	250	2010->	1		0,8	BR8ECM	3035		
250	EXC-F 250	250	2007->	1		0,8	CR9EK	4548		
250	EXC ENDURO 250	250	2003->	1		0,8	BR7ES	5122		
250	EXC GS 250	250	2003->	1		0,8	DCPR8E	4339		
250	EXC,EXC SIX DAYS 250	250	2010->	1		0,8	BR7ES	5122		
250	GS250 12.7MM REACH	250	1985->	1		0,8	B9HS	5810	BR9HS	4522
250	GS250 19.0MM REACH	250	1985->	1		0,8	B9ES	2611	BR9ES	5722
250	MC 250 12.7MM REACH	250	->1985	1		0,8	B9HS	5810	BR9HS	4522
250	MC250 19.0MM REACH	250	1985->1989	1		0,8	B9ES	2611	BR9ES	5722
250	SX-F 250	250	2003->2005	1		0,8	CR9EK	4548		
250	SX-F 250	250	2013->	1		0,8	LMAR9AI-8	97225		
250	SX 250 4 TAKT	250	2005->2009	1		0,8	CR9EK	4548		
250	XCF-W 250	250	2010->	1		0,8	CR9EK	4548		
250	XC,XC-W 250	250	2010->	1		0,8	BR7ES	5122		
300	300 EXC	300	2018->	1		1,3	ZGR7GI-13G	96760		
300	EXC,EXC SIX DAYS 300	300	2011->	1		0,8	BR7ES	5122		
300	XC,XC-W 300	300	2011->	1		0,8	BR7ES	5122		
350	EXC-F 350	350	2011->	1		0,8	LMAR9AI-8	97225		
350	FREERIDE SX	350	2011->	1		0,8	LMAR9AI-8	97225		
375	EXC RACING 375	375	2009->	1		0,9	LKAR8A-9	4786		
390	390 DUKE	390	2014->	1		0,9	LKAR8AI-9	6706	LKAR8A-9	4786
390	FE 390	390	2010->	1		0,9	LKAR8AI-9	6706	LKAR8A-9	4786
400	EXC 400	400	2003->	1		0,8	DCPR8E	4339		
400	EXC 400	400	2010->	1		0,9	LKAR8AI-9	6706	LKAR8A-9	4786
400	GS,MC,400	400	1987->1990	1		0,8	B9HS	5810	BR9HS	4522
400	SX LC4 400	400	2000->	1		0,8	CR8EK	3478		
400	XC-W 400	400	2010->	1		0,9	LKAR8AI-9	6706	LKAR8A-9	4786
450	450 SX-F	450	2015->	1		0,9	LKAR8AI-9	6706	LKAR8A-9	4786



MOTOR CYCLES



Model	Type	Capacity	Year	Cyl	Engine	Gap	Recommended	Stock Code	Alternative	Stock Code
KTM										
450	EXC 450	450	2003->	1		0,8	DCPR8E	4339		KTM
450	EXC 450	450	2008->	1		0,8	LKAR8A-9	4786		
450	EXC 450	450	2008->	1		0,9	LKAR8A-9	4786		
450	EXC,EXC SIX DAYS 450	450	2010->	1		0,9	LKAR8AI-9	6706	LKAR8A-9	4786
450	FE,FX 450	450	2010->	1		0,9	LKAR8AI-9	6706	LKAR8A-9	4786
450	MXC,GS 450	450	2003->	1		0,8	DCPR8E	4339		
450	SMR 450	450	2005->	1		0,8	DCPR8E	4339		
450	SX-F 450	450	2007->	1		0,8	CR9EK	4548		
450	SX-F 450	450	2007->	1		0,8	CR9EK	4548		
450	SX 450	450	2003->	1		0,8	DCPR8E	4339		
450	SX,SX-F 450	450	2010->	1		0,8	CR9EK	4548		
450	XC-W,XC-W SIX DAYS 450	450	2010->	1		0,9	LKAR8AI-9	6706	LKAR8A-9	4786
500	DXC,EXC 500	500	1989->1992	1		0,8	B9ES	2611	BR9ES	5722
500	GS 500	500	1983->1990	1		0,8	B10EG	3630	BR10EG	3830
500	GS 500	500	1988->1989	1		0,7	D8EA	2120	DR8EA	7162
500	MC 500	500	1983->1990	1		0,6	B10ES	7928		
500	MX 500	500	1984->1987	1		0,8	B9EG	3530	BR9EG	3230
500	SX 500	500	1993->	1		0,6	B10ES	7928		
505	SX 505	505	2010->	1		0,8	CR9EK	4548		
510	EXC RACING 510	510	2008->	1		0,9	LKAR8A-9	4786		
510	XC DESERT RACING 510	510	2007->	1		0,8	DCPR8E	4339		
520	EXC 520	520	1999->2002	1		0,8	CR8EK	3478		
520	EXC 520	520	2002->	1		0,8	DCPR8E	4339		
520	EXC LC4 520	520	2000->	1		0,8	CR8EK	3478		
520	SX 520	520	1999->2002	1		0,8	CR8EK	3478		
520	SX 520	520	2002->	1		0,8	DCPR8E	4339		
525	EXC,MXC,SMR 525	525	2003->2005	1		0,8	DCPR8E	4339		
530	EXC 530	530	2008->2009	1		0,9	LKAR8A-9	4786		
530	EXC,SIX DAYS,XC-W,XC-W SIX DAYS 530	530	2010->	1		0,9	LKAR8AI-9	6706	LKAR8A-9	4786
570	FE,FS 570	570	2010->	1		0,9	LKAR8AI-9	6706	LKAR8A-9	4786
600	ENDURA 600	600	1990->1992	1		0,7	D8EA	2120	DR8EA	7162
600	MX 600	600	1986->1990	1		0,7	D8EA	2120	DR8EA	7162
640	ADVENTURE 625	625	2000->	1		0,9	DPR8EA-9	4929		
640	DUKE 625	625	1998->2001	1		0,7	DR8EA	7162		
640	DUKE2 LC4 625	625	2000->	1		0,9	DPR8EA-9	4929		
640	E SUPERMOTO LC4 625	625	2000->	1		0,9	DPR8EA-9	4929		
640	LC4 RALLY ADV 625	625	1999->2002	1		0,7	DR8EA	7162		
640	SUPERMOTO LC4 625	625	2001->	1		0,7	DR8EA	7162		
650	ENDURA LC4 650	650	2008->	1		0,9	LKAR8A-9	4786		
660	LC4 650	650	2003->	1		0,7	DR9EIX	4772	D9EA	2420
654	PRESTIGE 654	654	2007->	1		0,9	LKAR8AI-9	6706	LKAR8A-9	4786
690	690 DUKE	690	2012->	1		0,9	LKAR8AI-9 + LMAR7A-9	6706 + 4908		
690	DUKE BLACK,ORANGE, WHITE 690	690	2010->2011	1		0,9	LKAR8AI-9	6706	LKAR8A-9	4786
690	ENDURO,ENDURO R 690	690	2010->	1		0,9	LKAR8AI-9	6706	LKAR8A-9	4786
690	SMC 690	690	2011->	1		0,9	LKAR8AI-9	6706	LKAR8A-9	4786
690	SUPERMOTO 690	690	2007->	1		0,9	LKAR8AI-9	6706	LKAR8A-9	4786
700	DUKE 3 LC4 700	700	2008->	1		0,9	LKAR8A-9	4786		
780	SX 780	780	2006->	1		0,9	LKAR8A-9	4786		
950	ADV 950	950	2003->2005	2		0,8	CR8EIX	4218	CR8E	1275
950	ADVENTURE 950	950	2003->	2		0,8	CR8EK	3478		
950	LC8 950	950	2003->	2		0,8	CR8EK	3478		
950	LC8 950	950	2006->	2		0,8	KR8DI	4742	DCPR8E	4339
950	LC8 ADV 950	950	2003->2004	2		0,8	CR8EK	3478		
950	LC8 EFI 950	950	2009->	2		0,8	KR8DI	4742	DCPR8E	4339
950	SUPER ENDURO 950	950	2006->	2		0,8	CR8EK	3478		
950	SUPERMOTO 950	950	2005->	2		0,8	CR8EK	3478		
990	990 SMT	990	2009->	2		0,8	KR8DI	4742	DCPR8E	4339
990	990 SMT	990	2009->	2		0,8	KR8DI	4742	DCPR8E	4339
990	ADVENTURE/R 990	990	2010->	2		0,9	LKAR8BI-9	1553		
990	SUPER DUKE OLIVE, ORANGE 990	990	2010->	2		0,8	KR8DI	4742	DCPR8E	4339
990	SUPER DUKE R 990	990	2010->	2		0,9	LKAR8AI-9	6706	LKAR8A-9	4786
990	SUPERMOTO R, T ORANGE, T SILVER 990	990	2010->	2		0,8	KR8DI	4742	DCPR8E	4339
1000	DUKE 1000	1000	2004->	2		0,8	DCPR8E	4339		
1000	SUPERDUKE 1000	1000	2005->	2		0,8	DCPR8E	4339		
1000	990 SUPERMOTO	1000	2009->	2		0,8	KR8DI	4742	DCPR8E	4339
1000	ADVENTURE S 1000	1000	2006->	2		0,8	DCPR8E	4339		
1050	1050 ADVENTURE	1050	2015->	2		1	LKAR9BI9 + LMAR7DI-10	6205+96956		
1050	ADVENTURE	1050	2015->2016	2		0,9	LKAR9BI-10 + LMAR7DI-10	95371+96956		
1090	1090 ADVENTURE S	1090	2017->	2		1	LKAR9BI9 + LMAR7DI-10	6205+96956		



MOTOR CYCLES



Model	Type	Capacity	Year	Cyl	Engine	Gap	Recommended	Stock Code	Alternative	Stock Code
KTM										
1090	ADVENTURE R/L	1090	2017->	2		0,9	LKAR9BI-10 + LMAR7DI-10			KTM
1148	RC8 1148	1148	2008->	2		0,9	LKAR9BI9	6205		
1190	RC8,R 1190	1190	2009->	2		0,9	LKAR9BI9 + LMAR7DI-10	6205+96956		
1290	SUPER ADVENTURE & R/S/T	1290	2015->2016	2		0,9	LKAR9BI-10+ LMAR7DI-10			
1290	SUPER DUE GT	1290	2016->	2		1	LKAR9BI-10 + LMAR7DI-10	95371+96956		
1290	SUPER DUKE R	1290	2014->2015	2		1	LKAR9BI9 + LMAR7DI-10	6205+96956		
KYMCO										
50	LIKE 50 2T	50	2009->	1		0,8	BR8HS	4322		
50	LIKE 50 4T	50	2009->	1		0,8	CR7HSA	4549		
50	SENTO 50	50	2009->	1		0,8	CR7HSA	4549		
50	SUPER8 50 2T	50	2009->	1		0,8	BR8HS	4322		
50	TOMOS 50 TX	50	2001->	1		0,6	B6HS	4510	BR6HS	3922
125	HIPSTER 125	125	1998->2000	1		0,8	CR8E	1275		
125	HIPSTER 125	125	2001->	1		0,7	DR8EA	7162		
125	DOWNTOWN 125I	125	2009->	1		0,8	CR7E	4578		
125	LIKE 125	125	2009->	1		0,8	CR7HSA	4549		
125	STRIKER 125	125	2001->2002	1		0,7	DR8EA	7162		
125	STRYKER 2 125	125	2002->	1		0,7	DR8EA	7162		
200	DOWNTOWN 200I	200	2009->	1		0,8	CR7E	4578		
200	LIKE 200I	200	2009->	1		0,8	CR7HSA	4549		
300	EXCITING 300I R	300	2009->	1		0,9	DPR6EA-9	5531		
300	XCITING 300 R	300	2016->	1		0,9	CPR6EAIX-9S	93921		
500	EXCITING 500I R	500	2009->	1		0,8	CR7E	4578		
LAVERDA										
125	CUSTOM STRADA 125	125	1986->	1		0,8	B9ES	2611	BR9ES	5722
125	CU,GS 125	125	1986->1986	1		0,8	B8ES	2411	BR8ES	5422
125	LB UNO 125	125	1985->1985	1		0,8	B8ES	2411	BR8ES	5422
350	ALPINO 350	350	1978->1982	2		0,7	D9EA	2420		
500	ALPINO 500	500	1977->1978	2		0,7	D9EA	2420		
600	OR ATLAS 600	600	1985->1986	2		0,7	D8EA	2120	DR8EA	7162
750	GT GS S SFC SF2 2D 750	750	1970->1972	3		0,8	BPR7ES	95164		
750	GTL 750	750	1973->1975	3		0,8	BPR7ES	95164		
750	SF2 1D, SF3 750	750	1973->1975	3		0,8	B8ES	2411	BR8ES	5422
750	SF, SF COMPETIZIONE 750	750	2000->2003	3		0,6	B10ES	7928		
750	SS, SPORT 750	750	1998->2000	3		0,6	B10ES	7928		
1000	JARAMA JOTA EXEC 1000	1000	1976->1982	3		0,8	B8ES	2411	BR8ES	5422
1000	SC, 3C,E, 3CL, SFC 1000	1000	1978->1980	3		0,8	B8ES	2411	BR8ES	5422
1200	JOTA, MIRAGE 1200	1200	1978->1979	4		0,8	B8ES	2411	BR8ES	5422
LEM										
50	LX2 50	50	1997->	1		0,7	B7HS	5110	BR7HS	4122
LINHAI										
260	LH 260	260	2005->	1		0,7	DR8EA	7162		
MAICO										
125	GS,MC 125	125	1978->1979	1		0,8	B9ES	2611	BR9ES	5722
250	GSE 250	250	1992->1993	1		0,8	B9ES	2611	BR9ES	5722
250	GS,MC 250	250	1994->	1		0,8	B9ES	2611	BR9ES	5722
350	RX 350	350	1974->1975	1		0,8	B8HS	5510	BR8HS	4322
350	TAIFUN 350	350	1978->1982	1		0,7	B7HS	5110	BR7HS	4122
360	GS,MC 360	360	1989->1992	1		0,5	B9HS	5810	BR9HS	4522
400	GS,MC 400	400	1974->1983	1		0,8	B9ES	2611	BR9ES	5722
450	MC 450	450	1972->1974	1		0,8	B9ES	2611	BR9ES	5722
490	GS,MC 490	490	->1983	1		0,8	B9ES	2611	BR9ES	5722
500	GS,MC 500	500	1979->1982	1		0,8	B9ES	2611	BR9ES	5722
MONTESA										
340	COTA 304 + COTA 335	340	1969->1972	1		0,8	BPR5ES	94084		



MOTOR CYCLES



Model	Type	Capacity	Year	Cyl	Engine	Gap	Recommended	Stock Code	Alternative	Stock Code
MOTO GUZZI						MOTO GUZZI				
500	V50, V50II, V50III	500	1981->1987	2		0,8	B7ES	1111	BR7ES	5122
650	SP 650	650	1982->1985	2		0,8	B7ES	1111	BR7ES	5122
650	V65 LARIO	650	>1986	2		0,7	C7HSA	4629	CR7HSA	4549
700	V7 700	700	2008->	2		0,8	B8ES	2411	BR8ES	5422
750	BREVA TOURING 750	750	2006->	2		0,8	BR8ES	5422		
750	NEVADA CLASSIC IE 750	750	2004->	2		0,8	BR8ES	5422		
750	S 750	750	1972->1974	2		0,8	B7ES	1111	BR7ES	5122
750	S 750	750	1974->	2		0,8	B7ES	1111	BR7ES	5122
750	V7 CAFE CLASSIC 750	750	2009->	2		0,8	BR8ES	5422		
750	V7 CLASSIC 750	750	2008->	2		0,8	BR8ES	5422		
850	LE MANS 850	850	1978->1981	2		0,8	BPR6ES	96989		
850	850T	850	1992->	2		0,8	B8ES	2411	BR8ES	5422
850	GT, CALIFORNIA, T3 850	850	1975->1981	2		0,8	BPR6ES	96989		
850	T5 850	850	1983->1987	2		0,8	BPR6ES	96989		
850	V7 SPORT 850	850	1982->1991	2		0,8	B9ES	2611	BR9ES	5722
940	BELLAGIO 940	940	2007->	2		0,8	BPR6ES+PMR8B	96989+6378		
1000	LE MANS 1000	1000	1990->	2		0,8	BPR6ES	96989		
1000	V G5 CONVERT,CX,XP 1000	1000	1992->	2		0,8	BPR6ES	96989		
1100	V11 LE MANS NERO CORSA	1100	2004->	2		0,8	BPR6ES	96989		
1100	V11 SCURA	1100	2003->	2		0,8	BPR6ES	96989		
1150	GRISO 8V SPECIAL EDITION	1150	2009->	2		0,8	CR8EK	3478		
1150	NORGE GT 1150	1150	2006->2009	2		0,8	BPR6ES+PMR8B	96989+6378		
1150	STELVIO 1150	1150	2008->	2		0,8	CR8EK	3478		
1150	STELVIO 1150 NTX	1150	2009->	2		0,8	CR8EK	3478		
1200	BREVA 1200	1200	2007->	2		0,8	BPR6ES+PMR8B	96989+6378		
1200	GT 1200	1200	2006->	2		0,8	BPR6ES	96989		
1200	GT 1200 TWIN SPARK	1200	2006->	2		0,8	BPR6ES+PMR8B	96989+6378		
1200	NORDE 1200	1200	2006->	2		0,8	BPR6ES	96989		

MOTORCYCLES

MV AGUSTA						MV AGUSTA				
675	BRUTALE 675, F3	675	2012->	3		0,8	CR9EK	4548		
750	BRUTALE 750	750	2000->	4		0,8	CR9EK	4548		
750	F4 S1 BIPOSTO ORO S 750	750	2000->	4		0,8	CR9EK	4548		
800	BRUTALE 800	800	2012->	3		0,9	CR9EIA-9	6289	CR9E	6263
800	RIVALE 800	800	2013->	3		0,9	CR9EIA-9	6289	CR9E	6263
989	BRUTALE R 989	989	2008->	4		0,8	CR9EB	6955		
1000	F4 SENNA 1000	1000	2006->	4		1	R0045Q-10	4216		
1090	BRUTALE 1090 R	1090	2012->	4		0,8	CR9EB	6955		
1078	BRUTALE 1078RR	1100	2008->	4		0,8	CR9EB	6955		
1078	F4 1078RR	1100	2008->	4		0,8	CR9EB	6955		

NORTON						NORTON				
600	DOMINATOR 600	600	1949->	2		0,8	B6ES	7310	BP6ES	91076
650	C652 SM	650	1999->	2		0,8	D8EA	2120	DR8EA	7162
650	MANXMAN 650	650	1946-1963->	2		0,8	BP7ES	95442		
750	ATLAS 750	750	1962->1968	2		0,8	BP8ES	2912	BP9ES	7526
750	COMMANDO FASTBACK 750	750	1967->1973	2		0,8	BP7ES	95442		
750	COMMANDO ROADSTER 750	750	1970->1975	2		0,8	BP7ES	95442		
750	RANGER P11A 750	750	1967->1968	2		0,8	BP8ES	2912	BP9ES	7526
1000	F1 ROTARY ENGINE	1000	1981->1992	4		0,8	C8E	7471	CR8E	1275

PGO						PGO				
90	PMX 90	90	1991->1993	1		0,7	BP7HS	5111		
110	PMX SPORT 110	110	1990->1994	1		0,7	BP7HS	5111		
125	G-MAX 125	125	2006->	1		0,7	C7HSA	4629	CR7HSA	4549
125	T-REX 125	125	1999->	1		0,7	C7HSA	4629	CR7HSA	4549

PUZEY						PUZEY				
125	125 PIT	125	2011->	1		0,8	C7HSA	4629	CR7HSA	4549
125	GWIZZ 125	125	2011->	1		0,8	C7HSA	4629	CR7HSA	4549
125	MEGELLI 125	125	2011->	1		0,8	D8EA	2120	DR8EA	7162
125	MXR 125	125	2011->	1		0,8	C7HSA	4629	CR7HSA	4549
150	150 PIT	150	2011->	1		0,8	C7HSA	4629	CR7HSA	4549
150	MXR 150	150	2011->	1		0,8	C7HSA	4629	CR7HSA	4549
250	LC2 250	250	2011->	1		0,8	D8EA	2120	DR8EA	7162
250	MEGELLI 250	250	2011->	1		0,8	D8EA	2120	DR8EA	7162
250	XTR 250	250	2011->	1		0,8	D8EA	2120	DR8EA	7162
300	300LC	300	2011->	1		0,8	D8EA	2120	DR8EA	7162
300	XTR4 300	300	2011->	1		0,8	BP5HS	4111		
500	500AC	500	2011->	1		0,9	DPR8EA-9	4929		
500	XTR4 500	500	2011->	1		0,8	BP5HS	4111		



MOTOR CYCLES



Model	Type	Capacity	Year	Cyl	Engine	Gap	Recommended	Stock Code	Alternative	Stock Code
REGAL RAPTOR						REGAL RAPTOR				
300	SPIDER 300	300	2011->	2		0,8	D8EA	2120	DR8EA	7162
350	CRUISER 350	350	2011->	2		0,8	D8EA	2120	DR8EA	7162
350	DAYTONA 350	350	2011->	2		0,8	D8EA	2120	DR8EA	7162
350	SPIDER 350	350	2011->	2		0,8	D8EA	2120	DR8EA	7162
SUZUKI						SUZUKI				
50	50DC	50	1976->1977	1		0,7	BP4HS	3611	BPR4HS	7823
50	50N	50	1984->1985	1		0,6	BP6HS	4511	BPR6HS	7022
50	A50K	50	1988->1993	1		0,7	BP7HS	5111		
50	A50,D,E	50	1990->1999	1		0,8	B8HS	5510	BR8HS	4322
50	AD50W,WK,WM,R	50	1971->1974	1		0,6	BP6HS	4511	BPR6HS	7022
50	C1 50F3	50	1989->1990	1		0,6	BP6HS	4511	BPR6HS	7022
50	CP50	50	1985->1992	1		0,6	BP6HS	4511	BPR6HS	7022
50	CP50F	50	1990->1999	1		0,6	BP6HS	4511	BPR6HS	7022
50	CS50	50	1970->1971	1		0,7	BP4HS	3611	BPR4HS	7823
50	CX50	50	1981->	1		0,6	BP6HS	4511	BPR6HS	7022
50	CY50	50	1981->1982	1		0,6	BP6HS	4511	BPR6HS	7022
50	CY50F	50	1985->1992	1		0,6	BP6HS	4511	BPR6HS	7022
50	DR 50ET	50	1978->1985	1		0,6	BP6HS	4511	BPR6HS	7022
50	FA50	50	1986->	1		0,7	BP4HS	3611	BPR4HS	7823
50	FA50/K	50	1981->1984	1		0,7	BP4HS	3611	BPR4HS	7823
50	FS50	50	1981->	1		0,7	BP4HS	3611	BPR4HS	7823
50	FZ50	50	1979->1982	1		0,7	BP4HS	3611	BPR4HS	7823
50	JR50,R,X,L,N	50	1979->1993	1		0,7	BP4HS	3611	BPR4HS	7823
50	QM50QWA	50	1979->1980	1		0,7	BP4HS	3611	BPR4HS	7823
50	RB 50	50	1985->1991	1		0,7	C6HSA	3228	CR6HSA	2983
50	RG50	50	1988->	1		0,8	B8ES	2411	BR8ES	5422
50	RG50E	50	1989->1991	1		0,8	BPR7ES	95164		
50	RG50W,K,R	50	1987->1988	1		0,8	BPR7ES	95164		
50	TS50ERK	50	1991->1993	1		0,6	BP6HS	4511	BPR6HS	7022
50	TS50W,WG,WP	50	1994->1998	1		0,8	BPR7ES	95164		
50	TS50XAE	50	1998->	1		0,6	BP6HS	4511	BPR6HS	7022
50	TS50,ER,ERA,ERAP,K,P,X	50	1984->	1		0,6	BP6HS	4511	BPR6HS	7022
50	TV50M,P	50	1981->1984	1		0,8	BPR8ES	3923		
80	A80	80	1978->1979	1		0,7	BP7HS	5111		
80	DS80,X,L,N,P	80	1996->	1		0,8	B7ES	1111	BR7ES	5122
80	FR80	80	1983->1984	1		0,6	BP6HS	4511	BPR6HS	7022
80	FR80M	80	1984->1987	1		0,6	BP6HS	4511	BPR6HS	7022
80	JR80	80	2001->	1		0,8	BPR7ES	95164		
80	RM80E	80	1982->	1		0,8	B9ES	2611	BR9ES	5722
80	RM80,H,X,P,R,N	80	1991->	1		0,8	B9ES	2611	BR9ES	5722
80	RM80,M	80	1982->	1		0,8	B9ES	2611	BR9ES	5722
85	RM85	85	2002->2005	1		0,8	BR10EG	3830		
85	RM85L	85	2002->2005	1		0,8	BR10EG	3830		
85	RM85L	85	2002->2005	1		0,8	BR10EG	3830		
90	RV90B	90	1972->1979	1		0,6	BP6HS	4511	BPR6HS	7022
100	A100	100	1995->	1		0,7	BP7HS	5111		
100	A100M	100	1977->1979	1		0,6	BP6HS	4511	BPR6HS	7022
100	A100N	100	1976->	1		0,6	BP6HS	4511	BPR6HS	7022
100	AG100JT	100	1995->	1		0,7	BP7HS	5111		
100	AX100	100	1979->1982	1		0,6	BP6HS	4511	BPR6HS	7022
100	GP100X	100	1978->1992	1		0,8	B8HS	5510	BR8HS	4322
100	RM100,X	100	1976->1979	1		0,8	B9ES	2611	BR9ES	5722
120	B120M,D	120	1983->1987	1		0,7	BP7HS	5111		
125	AN125	125	1995->1996	1		0,8	CR7E	4578		
125	DR125SJ	125	1994->1996	1		0,7	D8EA	2120	DR8EA	7162
125	DR125SM	125	2008->	1		0,7	DR8EA	7162		
125	DRZ125L	125	2003->2009	1		0,7	DR8EA	7162		
125	GN 125	125	2011->	1		0,8	DR8EA	7162		
125	GP125	125	1978->1989	1		0,8	B8HS	5510	BR8HS	4322
125	GS125D,ES	125	1982->1983	1		0,7	D8EA	2120	DR8EA	7162
125	RG125R	125	1985->	1		0,8	BR9ECM	3252		
125	RM125	125	1986->	1		0,8	B9EG	3530	BR9EG	3230
125	RM125	125	1987->	1		0,8	B9ES	2611	BR9ES	5722
125	RM125F,N	125	1982->1991	1		0,8	B9EG	3530	BR9EG	3230
125	RV125 K7	125	2007->	1		0,8	CR8E	1275		
125	TC125	125	1972->1977	1		0,8	B8HS	5510	BR8HS	4322
125	TF125	125	1975->1977	1		0,8	B7ES	1111	BR7ES	5122
125	TF125,X	125	1982->1983	1		0,8	B7ES	1111	BR7ES	5122
125	TS125X	125	1978->1981	1		0,8	B8ES	2411	BR8ES	5422
125	TS125XU	125	1976->1977	1		0,8	B8ES	2411	BR8ES	5422
160	LT160EK	160	1989->1989	1		0,7	D7EA	7912	DR7EA	7839
175	PE175	175	1979->	1		0,6	B10ES	7928		



MOTOR CYCLES



Model	Type	Capacity	Year	Cyl	Engine	Gap	Recommended	Stock Code	Alternative	Stock Code
SUZUKI										
175	PE175	175	1978->	1		0,8	B8ES	2411	BR8ES	5422
175	PE175F	175	1980->	1		0,6	B10ES	7928		
185	TC185	185	1974->1977	1		0,7	B7HS	5110	BR7HS	4122
185	TS185ERZ,ERP	185	1990->	1		0,8	BPR7ES	95164		
185	TS185,X	185	1982->	1		0,8	B7ES	1111	BR7ES	5122
185	TS185,X	185	1977->	1		0,7	B7HS	5110	BR7HS	4122
185	TS185,X	185	1981->	1		0,8	BPR7ES	95164		
200	B200	200	1981->	1		0,8	B8ES	2411	BR8ES	5422
200	B200	200	1980->	1		0,8	BPR6ES	96989		
200	B200N	200	1982->1984	1		0,8	B8ES	2411	BR8ES	5422
200	BURGMAN UH200	200	2007->	1		0,8	CR8EK	3478		
200	DF200ET	200	1992->	1		0,7	DR8EA	7162		
200	DR200	200	1986->1988	1		0,7	D8EA	2120	DR8EA	7162
200	DR200SE	200	1996->2005	1		0,7	DR8EA	7162		
200	DR200,J	200	1995->	1		0,7	D8EA	2120	DR8EA	7162
200	GT200	200	1978->1979	1		0,8	B8ES	2411	BR8ES	5422
200	SB200Z	200	1979->1983	1		0,8	B8ES	2411	BR8ES	5422
200	TS200X	200	1988->1989	1		0,8	B8ES	2411	BR8ES	5422
200	TS200XF	200	1984->1985	1		0,8	B8ES	2411	BR8ES	5422
250	DR250	250	1990->1993	1		0,7	D8EA	2120	DR8EA	7162
250	DR250S	250	1983->1985	1		0,7	D8EA	2120	DR8EA	7162
250	GN250	250	1983->1988	1		0,7	DR8EA	7162		
250	GN250,D,EDM,N	250	1984->1987	1		0,7	D8EA	2120	DR8EA	7162
250	GSX250T,L	250	1980->1981	1		0,7	D8EA	2120	DR8EA	7162
250	GT250	250	1976->1977	2		0,8	B9ES	2611	BR9ES	5722
250	PE250	250	1978->	1		0,8	B8ES	2411	BR8ES	5422
250	PE250	250	1979->	1		0,8	B9ES	2611	BR9ES	5722
250	PE250	250	1980->	1		0,6	B10ES	7928		
250	RG250	250	1984->1985	2		0,8	B9ES	2611	BR9ES	5722
250	RG250WD,WE	250	1983->1989	2		0,8	B9ES	2611	BR9ES	5722
250	RGV250K	250	1989->1990	2		0,8	BR9ES	5722		
250	RGV250P	250	1990->1997	2		0,8	BR9ECM	3252		
250	RM250	250	1981->	1		0,8	B9ES	2611	BR9ES	5722
250	RM250	250	2001->2005	1		0,8	BR8EG	3130		
250	RM250 K1	250	2001->	1		0,8	BR8EG	3130		
250	RM250N	250	2001->2008	1		0,8	B8ES	2411	BR8ES	5422
250	RMX250W	250	1993->1998	1		0,8	B9EG	3530	BR9EG	3230
250	RMZ 250	250	2007->	1		0,8	CR8E	1275		
250	RMZ250	250	2004->2006	1		0,8	CR8E	1275		
250	RMZ250	250	2006->	1		0,8	CR8E	1275		
250	TS250,X	250	1977->1979	1		0,8	B8ES	2411	BR8ES	5422
350	DR350SN,SP	350	1994->	1		0,9	DPR9EA-9	5329	DPR9EIX-9	5545
370	SP370	370	1978->1979	1		0,7	D8EA	2120	DR8EA	7162
400	AN400	400	1970->1973	1		0,8	CR7E	4578		
400	DR400	400	1980->	1		0,7	D8EA	2120	DR8EA	7162
400	DR400S	400	1980->	1		0,7	D8EA	2120	DR8EA	7162
400	DRZ400 S,Y,K1	400	2000->	1		0,8	CR8E	1275		
400	DRZ400SM	400	2000->2009	1		0,8	CR8E	1275		
400	GN400T	400	1981->1983	1		0,7	D8EA	2120	DR8EA	7162
400	GN400,TX,XX	400	1979->1980	1		0,7	D8EA	2120	DR8EA	7162
400	GS400,E,X	400	1977->1978	2		0,8	B8ES	2411	BR8ES	5422
400	GSX400E	400	1982->1985	2		0,7	D8EA	2120	DR8EA	7162
400	GSX400EF	400	1982->	2		0,7	D8EA	2120	DR8EA	7162
400	GSX400F	400	1980->	2		0,7	D8EA	2120	DR8EA	7162
400	GSX400T	400	1979->1984	2		0,7	D8EA	2120	DR8EA	7162
400	GSXR400	400	1993->	2		0,7	CR8EK	3478		
400	GSXR400	400	1993->	4		0,8	CR8EK	3478		
400	PE400,X	400	1980->1981	1		0,8	B9ES	2611	BR9ES	5722
400	RM400	400	1978->1979	1		0,8	B8ES	2411	BR8ES	5422
400	RMZ400	400	2007->	1		1	DIMR8C10		CR8E	1275
400	SP400	400	1980->	1		0,7	D8EA	2120	DR8EA	7162
425	GS425	425	1979->1979	2		0,8	B8ES	2411	BR8ES	5422
450	GS450E,ES,GA,L,T,TX	450	1980->1988	2		0,8	B8ES	2411	BR8ES	5422
450	GS450L	450	1985->	2		0,8	B8ES	2411	BR8ES	5422
450	GS450LF	450	1982->1983	2		0,8	B8ES	2411	BR8ES	5422
450	GS450SF	450	1985->1986	2		0,8	B8ES	2411	BR8ES	5422
450	RMX 450	450	2010->	1		1	DIMR8C10		CR8E	1275
450	RMZ450	450	2004->	1		1	CR8EIB-10	4948	CR8E	1275
450	RMZ450	450	2007->	1		1	DIMR8C10		CR8E	1275
450	RMZ450	450	2008->	1		1	DIMR8C10		CR8E	1275
500	DR500,D	500	1985->1985	1		0,7	D8EA	2120	DR8EA	7162
500	GS500EM	500	1989->2000	2		0,9	DPR8EA-9	4929		
500	GS500EP,ER	500	1993->2000	2		0,9	DPR8EA-9	4929		

MOTORCYCLES



MOTOR CYCLES



Model	Type	Capacity	Year	Cyl	Engine	Gap	Recommended	Stock Code	Alternative	Stock Code
SUZUKI										
500	GS500F	500	2004->	2		0,9	DPR8EA-9	4929		
500	RG500	500	1987->	4		0,8	B9ES	2611	BR9ES	5722
500	RM500	500	1981->1982	1		0,8	B8ES	2411	BR8ES	5422
500	RM500E	500	1983->1986	1		0,8	B8ES	2411	BR8ES	5422
500	RM500F	500	1981->1982	1		0,8	B8ES	2411	BR8ES	5422
550	GS550M,P,TX	550	1986->	2		0,8	B8ES	2411	BR8ES	5422
550	GS550,E,ES	550	1983->	2		0,8	B8ES	2411	BR8ES	5422
600	GSF600V	600	1995->	1		0,8	CR9EK	4548		
600	GSR600	600	2006->	4		0,8	CR9E	6263		
600	GSX-R600	600	1997->2005	4		0,8	CR9E	6263		
600	GSX-R600	600	2008->	4		0,9	CR9EIA-9	6289	CR9E	6263
600	GSX600F KATANA	600	1996->2005	4		0,8	CR9EK	4548		
600	GSXR600V	600	1997->2007	4		0,8	CR9E	6263		
650	AN650	650	2005->2009	1		0,8	CR8E	1275		
650	DL 650 V STORM TWIN SPARK	650	2012->	2		0,8	CR8EIX	4218	CR8E	1275
650	DL650 V-STORM	650	2004->2005	2		0,8	CR8EK	3478		
650	DL650 V-STROM	650	2004->	2		0,8	CR8E	1275		
650	DL650XAL7	650	2017->	1		0,9	MR8E-9	90527		
650	DR650RSEP	650	1990->	1		0,9	DPR9EA-9	5329	DPR9EIX-9	5545
650	DR650SE	650	1996->2005	1		0,8	CR10E	6264		
650	DR650SE	650	1996->2009	1		0,8	CR10E	6264		
650	GS650	650	1981->	4		0,8	DR8ESL	2923		
650	GS650G,GE,GL,GT,GX,M	650	1981->	4		0,7	D8EA	2120	DR8EA	7162
650	GSF 650,S	650	2005->	4		0,8	CR8EK	3478		
650	GSF650	650	2005->2006	4		0,8	CR9E	6263		
650	GSF650 K7	650	2007->	4		0,8	CR9E	6263		
650	GSF650S	650	2005->2006	4		0,8	CR9E	6263		
650	GSX 650 A,SA	650	2008->	4		0,8	CR8E	1275		
650	GSX 650 F	650	2008->	4		0,8	CR8E	1275		
650	GSX650 A/SA	650	2008->	4		0,8	CR8E	1275		
650	GSX650F	650	2008->	4		0,8	CR8E	1275		
650	LS650P SAVAGE	650	2000->2005	1		0,9	DPR8EA-9	4929		
650	SFV650 GLADIUS	650	2009->	2		0,9	CR9EIA-9	6289	CR9E	6263
650	SV 650	650	1999->2009	2		0,8	CR8E	1275		
650	SV 650	650	2016->	2		0,9	MR8E-9	90527		
650	SV650S	650	1999->2009	2		0,8	CR8E	1275		
650	SV650,S	650	1999->2005	4		0,8	CR8E	1275		
650	SV650,S	650	1999->2009	2		0,8	CR8E	1275		
650	V-STROM TRAVELLER 650	650	2010->	2		0,8	CR8EK	3478		
650	XF650 FREEWIND	650	2000->	2		0,8	CR10E	6264		
750	GS750	750	1980->	4		0,8	B8ES	2411	BR8ES	5422
750	GS750	750	1981->	4		0,7	D8EA	2120	DR8EA	7162
750	GS750D,E,P	750	1977->1979	4		0,8	B8ES	2411	BR8ES	5422
750	GS750ED,ESD,SD	750	1980->1983	4		0,7	D8EA	2120	DR8EA	7162
750	GS750S	750	1980->1983	4		0,7	D9EA	2420		
750	GSR750WN,WP	750	1999->	4		0,8	CR9EK	4548		
750	GSX750EE	750	1997->	4		0,7	D8EA	2120	DR8EA	7162
750	GSX750ES	750	1985->	4		0,7	D9EA	2420		
750	GSX750ES	750	1984->1984	4		0,7	D8EA	2120	DR8EA	7162
750	GSX750ESE	750	1989->	4		0,7	D8EA	2120	DR8EA	7162
750	GSX750E,EF,ES	750	1989->	4		0,7	D8EA	2120	DR8EA	7162
750	GSX750F KATANA	750	1999->2005	4		0,8	CR9EK	4548		
750	GSX750S	750	1989->1996	4		0,7	D8EA	2120	DR8EA	7162
750	GSX750,L,S,T	750	1989->1996	4		0,7	D8EA	2120	DR8EA	7162
750	GSXR750	750	1986->1987	4		0,7	D9EA	2420		
750	GSXR750	750	1994->2005	4		0,8	CR9E	6263		
750	GSXR750	750	2008->	4		0,9	CR9EIA-9	6289	CR9E	6263
750	GSXR750 J,K	750	1988->1989	4		0,6	JR9C	6193		
750	GSXR750 K6	750	2006->	4		0,8	CR9E	6263		
750	GSXR750 Y,K1	750	2000->	4		0,8	CR9E	6263		
750	GT750	750	1975->1977	3		0,8	B8ES	2411	BR8ES	5422
800	VL800 VOLUSIA	800	2001->	2		0,9	DPR7EA-9	5129		
800	VX800L,N,P	800	1990->1996	2		0,9	DPR8EA-9	4929		
800	VZ800	800	2009->	2		0,9	DPR7EA-9	5129		
800	VZ800	800	2009->	2		0,7	DR7EA	7839		
800	VZ800V	800	1997->2001	2		0,9	DPR8EA-9	4929		
800	VZ800,M800	800	2005->	2		0,9	DPR7EA-9	5129		
850	GS850G	850	1979->1988	4		0,8	B8ES	2411	BR8ES	5422
850	GS850GE	850	1979->1989	4		0,8	B8ES	2411	BR8ES	5422
900	RF900RV	900	1994->	4		0,8	CR9E	6263		
1000	DL 1000 V-STORM	1000	2013->	2		0,8	CR8EIX	4218	CR8E	1275
1000	DL1000	1000	2015->2016	4		0,9	LMAR8BI-9	91909		
1000	DL1000 V STORM	1000	2002->2005	2		0,8	CR8EK	3478		



MOTOR CYCLES



Model	Type	Capacity	Year	Cyl	Engine	Gap	Recommended	Stock Code	Alternative	Stock Code
SUZUKI										
1000	DL100XAL8	1000	2017->	2		0,9	LMAR8BI-9	91909		
1000	GS1000S	1000	1982->	4		0,8	B8ES	2411	BR8ES	5422
1000	GS1000_D,E,GL,GX,H	1000	1980->	4		0,8	B8ES	2411	BR8ES	5422
1000	GSX-R 1000R	1000	2013->	4		0,9	CR9EIA-9	6289	CR9E	6263
1000	GSX R-1000	1000	2001->2005	4		0,8	CR9E	6263		
1000	GSX R-1000	1000	2001->2005	4		1	CR9EIX	3521	CR9E	6263
1000	GSX R-1000	1000	2009->	4		0,9	CR9EIA-9	6289	CR9E	6263
1000	GSX R-1000 K3	1000	2003->	4		0,8	CR9E	6263		
1000	GSX R-1000 K1	1000	2000->2006	4		0,8	CR9E	6263		
1000	GSX R-1000 K7	1000	2007->	4		0,9	CR9EIA-9	6289	CR9E	6263
1000	SV1000S	1000	2003->	2		0,8	CR8EK	3478		
1000	TL1000R R	1000	1998->	2		0,8	CR9EK	4548		
1000	TL1000SV SV	1000	1997->	2		0,8	CR9E	6263		
1000	TL1000SW,SX,SY	1000	1997->	2		0,8	CR8EK	3478		
1100	GS1100EF,ES	1100	1984->1988	4		0,7	D8EA	2120	DR8EA	7162
1100	GSX1100EFF,ESF	1100	1984->1988	4		0,7	D9EA	2420		
1100	GSX1100E,S	1100	1985->	4		0,7	D8EA	2120	DR8EA	7162
1100	GSX1100F	1100	1987->	4		0,6	JR9C	6193		
1100	GSXR1100	1100	1989->1992	4		0,6	JR9C	6193		
1100	GSXR1100M	1100	1989->1993	4		0,7	JR9B	3188		
1100	GSXR1100W	1100	1993->	4		0,8	CR9E	6263		
1100	SGX1100	1100	1987->	4		0,7	DR8EA	7162		
1200	GS 1200SS	1200	1996->2002	4		0,8	IJR8B-9	4873	DPR8EA-9	4929
1200	GSF1200 BANDIT	1200	2000->	4		0,7	JR9B	3188		
1200	GSF1200V	1200	1996->	4		0,7	JR9B	3188		
1200	GSX1200	1200	1999->2001	4		0,7	JR9B	3188		
1250	GSF1250 BANDIT	1250	2007->	4		0,8	CR7E	4578		
1250	GSF1250S	1250	2007->	4		0,8	CR7E	4578		
1250	GSX1250	1250	2011->	4		0,8	CR7E	4578		
1300	GSX 1300 R HAYABUSA	1300	2008->	4		0,9	CR9EIA-9	6289	CR9E	6263
1300	GSX 1300R HAYABUSA	1300	1999->2005	4		0,8	CR9E	6263		
1300	GSX1300	1300	1999->	4		0,8	CR9E	6263		
1300	GSX1300RZ	1300	1999->2007	4		0,8	CR9E	6263		
1300	GSXR1300 HAYABUSA	1300	1999->	4		0,8	CR9E	6263		
1400	GSX1400	1400	2001->	4		0,8	CR8EK	3478		
1400	VS1400GLPR	1400	1987->	2		0,9	DPR8EA-9	4929		
1500	C 1500 INTRUDER	1500	2013->	2		0,9	CPR6EA-9S	1582		
1500	M1500 INTRUDER	1500	2009->	2		0,8	CR6E	6965		
1500	VL1500	1500	1999->	2		0,9	DPR7EA-9	5129		
1500	VL1500 INTRUDER C	1500	2005->	2		0,9	DPR7EA-9	5129		
1800	C 1800 R INTRUDER	1800	2008->	2		0,8	CR8EK	3478		
1800	C1800R INTRUDER	1800	2008->	2		0,8	CR8EK	3478		
1800	M1800R INTRUDER	1800	2006->	2		0,8	CR8EK	3478		
1800	VZR1800	1800	2001->	2		0,8	CR8EK	3478		
1800	VZR1800Z	1800	2007->2009	2		0,8	CR8EK	3478		
SYM										
50	SIMPLY 50	50	2009->	1		0,8	CR7HSA	4549		
50	SYMPHONY 50	50	2009->	1		0,8	CR7HSA	4549		
100	JET 100	100	1999->	1		0,8	BR8HS	4322		
125	GTS 125	125	2006->	1		0,8	CR8E	1275		
125	SHARK 125, R125	125	1999->	1		0,8	CR8E	1275		
125	SIMPLY 125	125	2009->	1		0,8	CR7HSA	4549		
125	SYMPHONY 125	125	2009->	1		0,8	CR7HSA	4549		
125	WOLF 125	125	2005->	1		0,8	DR8EA	7162		
250	GTS 250	250	2006->	1		0,8	CR8E	1275		
TM										
125	125EN	125	2003->	1		0,8	BR9EG	3230	BR9ES	5722
125	CROSS ENDURO 125	125	1994->	1		0,8	B10EG	3630	BR10EG	3830
250	250 EN	250	2003->	2		0,8	BR8EG	3130		
250	250 EN-F	250	2004->	2		0,8	CR8E	1275		
TRIUMPH										
650	T120R BONNEVILLE	650	1968->1974	3		0,8	BR8ES	5422		
650	T120V BONNEVILLE	650	1968->1974	3		0,8	BR8ES	5422		
675	DAYTONA	675	2006->	3		0,8	CR9EK	4548		
675	DAYTONA 675	675	2013->	3		0,9	CR9EIA-9	6289	CR9E	6263
675	DAYTONA 675 RR	675	2013->	3		0,8	CR9EIA-9	6289	CR9E	6263



MOTOR CYCLES



Model	Type	Capacity	Year	Cyl	Engine	Gap	Recommended	Stock Code	Alternative	Stock Code
TRIUMPH										
675	DAYTONA R	675	2008->	3		0,8	CR9EK	4548		
675	SPEED TRIPLE 675	675	2007->	3		0,8	CR9EK	4548		
750	750 TRIDENT LIQUID COOLED DOHC 95->	750	1991->1998	3		0,9	DPR9EA-9	5329	DPR9EIX-9	5545
750	T140D BONNEVILLE 750	750	1973->1980	2		0,8	B6ES	7310	BP6ES	91076
750	T140E BONNEVILLE 750	750	1973->1980	2		0,8	B6ES	7310	BP6ES	91076
790	T140V BONNEVILLE 790	790	2001->2003	2		0,9	DPR8EA-9	4929		
800	TIGER 800	800	2011->	3		0,8	CR9EK	4548		
800	TIGER 800 XC	800	2011->	3		0,8	CR9EK	4548		
865	AMERICA	865	2010->	2		0,9	DPR8EA-9	4929		
865	BONNEVILLE	865	2010->	2		0,9	DPR8EA-9	4929		
865	BONNEVILLE BLACK	865	2010->	2		0,9	DPR8EA-9	4929		
865	BONNEVILLE T100	865	2008->	2		0,9	DPR8EA-9	4929		
865	SCRAMBLER	865	2010->	2		0,8	DPR8EA-9	4929		
865	SPEED MASTER	865	2010->	2		0,9	DPR8EA-9	4929		
865	THRUXTON	865	2010->	2		0,9	DPR8EA-9	4929		
865	THRUXTON 900	865	2004->	2		0,9	DPR8EA-9	4929		
900	900 ADVENTURER LIQUID COOLED DOHC 95->	900	1996->2001	3		0,9	DPR8EA-9	4929		
900	900 DAYTONA LIQUID COOLED DOHC 95->	900	1994->1996	3		0,9	DPR9EA-9	5329	DPR9EIX-9	5545
900	900 SPEED TRIPLE LIQUID COOLED 95->	900	1997->	3		0,9	DPR8EA-9	4929		
900	900 SPRINT LIQUID COOLED DOHC 95->	900	1993->1996	3		0,9	DPR8EA-9	4929		
900	900 SUPER 111 LIQUID COOLED DOHC 95->	900	1994->1997	3		0,9	DPR9EA-9	5329	DPR9EIX-9	5545
900	900 THUNDERBIRD THUNDERBIRD LIQUID COOLED DOHC 95->	900	1995->2004	3		0,9	DPR8EA-9	4929		
900	900 TIGER LIQUID COOLED DOHC 95->	900	1993->1998	3		0,9	DPR9EA-9	5329	DPR9EIX-9	5545
900	900 TRIDENT LIQUID COOLED DOHC 95->	900	1991->1998	3		0,9	DPR9EA-9	5329	DPR9EIX-9	5545
900	900 TROPHY LIQUID COOLED DOHC 95->	900	1991->1995	3		0,9	DPR9EA-9	5329	DPR9EIX-9	5545
900	AMERICA LT	900	2006->	2		0,9	DPR8EA-9	4929		
900	SPEEDMASTER	900	2009->	2		0,9	DPR8EA-9	4929		
900	THRUXTON	900	2010->	2		0,9	DPR8EA-9	4929		
955	955 DAYTONA I	955	2002->2004	3		0,8	CR9EK	4548	CR9EIX	3521
1050	1050 TIGER	1050	2011->	3		0,8	CR9EK	4548		
1050	SPEED TRIPLE	1050	2011->	3		0,8	CR9EIX	3521		
1200	1200 DAYTONA LIQUID COOLED DOHC 95->	1200	1993->2000	4		0,9	DPR9EA-9	5329	DPR9EIX-9	5545
1200	1200 TROPHY LIQUID COOLED DOHC 95->	1200	1991->2003	4		0,9	DPR9EA-9	5329	DPR9EIX-9	5545
1200	TIGER EXPLORER	1215	2010->	3		0,9	DPR8EA-9	4929		
1200	TOURING SE	1215	2008->	3		0,9	DPR8EA-9	4929		
1600	THUNDER BIRD	1600	2010->	2		0,9	DPR6EA-9	5531		
1600	THUNDERBIRD STORM	1600	2009->	2		0,9	DPR6EA-9	5531		
1700	THUNDERBIRD COMMANDER	1700	2010->	3		0,9	DPR8EA-9	4929		
2300	ROCKET 3	2300	2004->	6		0,9	DPR8EA-9	4929		
2300	ROCKET 3 TWIN SPARK	2300	2009->	3		0,9	DPR8EA-9	4929		
VICTORY										
1634	HAMMER 100CU IN FREEDOM 1634	1634	2006->	2		0,9	CPR6EA-9S	1582		
1634	NESS SIGNATURE JACKPOT 1634	1634	2006->	2		0,9	CPR6EA-9S	1582		
1634	TOURING CRUISER 1634	1634	2006->	2		0,9	CPR6EA-9S	1582		
1634	VEGAS 1634	1634	2006->	2		0,9	CPR6EA-9S	1582		
1634	VEGAS 8 BALL 1634	1634	2006->	2		0,9	CPR6EA-9S	1582		
1634	VEGAS JACKPOT 1634	1634	2006->	2		0,9	CPR6EA-9S	1582		
1700	ARLEN NESS	1731	2011->	2		0,8	DCPR6E	3481		
1700	BOARDWALK	1731	2011->	2		0,8	DCPR6E	3481		
1700	CORY NESS CROSS COUNTRY	1731	2011->	2		0,8	DCPR6E	3481		
1700	CROSS COUNTRY	1731	2011->	2		0,8	DCPR6E	3481		
1700	CROSS COUNTRY TOUR	1731	2011->	2		0,8	DCPR6E	3481		
1700	CROSS ROADS CLASSIC	1731	2011->	2		0,8	DCPR6E	3481		
1700	HAMMER 8 BALL	1731	2011->	2		0,8	DCPR6E	3481		
1700	HAMMER S	1731	2011->	2		0,8	DCPR6E	3481		
1700	HARD BALL	1731	2011->	2		0,8	DCPR6E	3481		
1700	HIGHBALL	1731	2011->	2		0,8	DCPR6E	3481		
1700	JACKPOT	1731	2011->	2		0,8	DCPR6E	3481		
1700	JUDGE	1731	2011->	2		0,8	DCPR6E	3481		
1700	VEGAS 8 BALL	1731	2011->	2		0,8	DCPR6E	3481		
1700	VISION TOUR	1731	2011->	2		0,8	DCPR6E	3481		
1700	ZACH NESS TOUR	1731	2011->	2		0,8	DCPR6E	3481		
VUKA										
125	RS 125	125	2011->	1		0,8	C7HSA	4629	CR7HSA	4549
125	RT 125	125	2011->	1		0,8	C7HSA	4629	CR7HSA	4549
125	TMI 125	125	2011->	1		0,8	C7HSA	4629	CR7HSA	4549

MOTORCYCLES



MOTOR CYCLES



Model	Type	Capacity	Year	Cyl	Engine	Gap	Recommended	Stock Code	Alternative	Stock Code
YAMAHA										
110	TTR110	1	2013->	1		0,8	CR6HSA	2983		
50	BW 50 R12	50	2001->	1		0,8	BR8HS	4322		
50	CE50	50	1986->1987	1		0,7	BP4HS	3611	BPR4HS	7823
50	CW50W	50	1991->	1		0,7	BP7HS	5111		
50	CY50	50	1994->	1		0,7	BPR6HS	7022		
50	DT50 LC	50	1988->1990	1		0,8	B8ES	2411	BR8ES	5422
50	GT50B,D	50	1983->	1		0,7	B7HS	5110	BR7HS	4122
50	MR50,H	50	1984->	1		0,7	B7HS	5110	BR7HS	4122
50	PW50	50	1981->2006	1		0,7	BP4HS	3611	BPR4HS	7823
50	PW50	50	2013->	1		0,8	BPR4HS	7823		
50	RD50DX	50	1986->1989	1		0,8	B8HS	5510	BR8HS	4322
50	RZ50	50	1982->	1		0,8	B8ES	2411	BR8ES	5422
50	RZ50K	50	1982->	1		0,8	B8ES	2411	BR8ES	5422
50	SA50,H,M	50	1982->1986	1		0,7	BP4HS	3611	BPR4HS	7823
50	SH50	50	1987->2001	1		0,6	BP6HS	4511	BPR6HS	7022
50	SH50T	50	1993->	1		0,6	BP6HS	4511	BPR6HS	7022
50	TTR50E	50	2006->	1		0,8	CR7HSA	4549		
50	TZR50	50	2013->	1		0,8	CR8E	1275		
50	V50E	50	2007->2007	1		0,7	B7HS	5110	BR7HS	4122
50	YA50	50	1997->	1		1	BP7HS-10	7829	BPR7HS-10	1092
50	YB50,S	50	1981->1983	1		0,7	B7HS	5110	BR7HS	4122
50	YSR50	50	1988->1992	1		0,8	B8HS	5510	BR8HS	4322
60	JT1,L, JT2,M 60	60	->1975	1		0,7	B7HS	5110	BR7HS	4122
60	JT1,L, JT2,M 60	60	->1975	1		0,7	B7HS	5110	BR7HS	4122
60	YT60S	60	->1975	1		0,6	BP6HS	4511	BPR6HS	7022
70	70	70	2013->	1		0,8	LKR7E	1643		
80	CV80	80	1983->1984	1		0,7	BP7HS	5111		
80	CV80J	80	1982->1986	1		0,6	BP6HS	4511	BPR6HS	7022
80	LB80	80	1976->1978	1		0,6	BP6HS	4511	BPR6HS	7022
80	LB80-2A,AC,AD,H,3,3D	80	1976->1978	1		0,6	B6HS	4510	BR6HS	3922
80	LB80-2HD	80	1976->1978	1		0,7	B7HS	5110	BR7HS	4122
80	LB80II	80	1981->1985	1		0,7	B7HS	5110	BR7HS	4122
80	PW80	80	1983->1990	1		0,6	BP6HS	4511	BPR6HS	7022
80	PW80	80	1983->2006	1		0,7	BPR6HS	7022		
80	PW80K	80	1984->	1		0,6	BP6HS	4511	BPR6HS	7022
80	PW80L	80	1983->2006	1		0,6	BP6HS	4511	BPR6HS	7022
80	PW80N	80	1983->2006	1		0,6	BP6HS	4511	BPR6HS	7022
80	YZ80	80	1985->	1		0,8	B9ES	2611	BR9ES	5722
80	YZ80C,D,E,H	80	1976->1981	1		0,8	B8ES	2411	BR8ES	5422
80	YZ80E	80	->1992	1		0,8	B10EG	3630	BR10EG	3830
80	YZ80J	80	1982->	1		0,8	B9ES	2611	BR9ES	5722
80	YZ80K/L	80	1982->	1		0,8	B9ES	2611	BR9ES	5722
80	YZ80N	80	1983->1986	1		0,8	B9ES	2611	BR9ES	5722
80	YZ80S	80	1982->	1		0,8	BP9ES	7526	BR9ES	5722
80	YZ80T	80	1982->	1		0,8	B9ES	2611	BR9ES	5722
85	YZ85	85	2006->	1		0,8	BR10EG	3830		
85	YZ85	85	2013->	1		0,8	BR10EG	3830		
90	TTR90	90	2000->	1		0,7	CR6HSA	2983		
90	V90	90	2007->	1		0,7	B7HS	5110	BR7HS	4122
90	YA90	90	1993->	1		0,8	BR7HS	4122		
100	AG100	100	1980->	1		0,7	B7HS	5110	BR7HS	4122
100	AG100	100	1982->	1		0,8	B7ES	1111	BR7ES	5122
100	AG100H,J,K	100	1984->	1		0,8	B7ES	1111	BR7ES	5122
100	RT100	100	1990->2000	1		0,8	BR7ES	5122		
100	RT100	100	2000->	1		1	BR8HS-10	1134		
100	RT100	100	2002->	1		0,8	BR7ES	5122		
100	YB100	100	1987->1992	1		0,7	BP7HS	5111		
100	YB100M	100	1993->	1		0,8	B8HS	5510	BR8HS	4322
100	YB100P	100	1985->	1		0,7	B7HS	5110	BR7HS	4122
100	YZ100L	100	1982->	1		0,8	B9ES	2611	BR9ES	5722
100	YZ100,E,H,J	100	1976->1981	1		0,6	B10ES	7928		
110	TT R110 E	110	2008->	1		0,7	CR6HSA	2983		
115	RX115	115	1993->	1		0,8	BP8HS	2630	BPR8HS	3725
125	DT125	125	1986->	1		0,8	B8ES	2411	BR8ES	5422
125	DT125E,ED,F,H,MX	125	1983->	1		0,8	B8ES	2411	BR8ES	5422
125	DT125K,J,LC	125	1974->1981	1		0,8	B8ES	2411	BR8ES	5422
125	DT125RE	125	2004->	1		0,8	B8ES	2411	BR8ES	5422
125	RD125 12.7MM REACH	125	1984->	1		0,8	B8HS	5510	BR8HS	4322
125	RD125 19.0MM REACH	125	1976->	1		0,8	B8ES	2411	BR8ES	5422
125	RD125C	125	1976->	1		0,8	B8ES	2411	BR8ES	5422
125	RD125D-DX	125	1973->1975	1		0,8	B7ES	1111	BR7ES	5122
125	RD125LC	125	1976->	1		0,8	B8ES	2411	BR8ES	5422
125	RS125E	125	1982->	1		0,7	B7HS	5110	BR7HS	4122
125	RZ125L	125	1972->	1		0,8	B8ES	2411	BR8ES	5422



MOTOR CYCLES



Model	Type	Capacity	Year	Cyl	Engine	Gap	Recommended	Stock Code	Alternative	Stock Code
YAMAHA										
125	TA125,A	125	1974->1977	1		0,6	B10ES	7928		
125	TTR125	125	2007->	1		0,8	CR7HSA	4549		
125	TTR125E L T	125	2000->2006	1		0,8	CR7HSA	4549		
125	TY125	125	1977->1981	1		0,8	BR7ES	5122		
125	TZR125	125	1993->1997	1		0,8	BR9ECM	3252		
125	WR125R	125	2009->	1		0,8	CR8E	1275		
125	WR125R,X	125	2009->	1		0,8	CR8E	1275		
125	WR125X	125	2009->	1		0,8	CR8E	1275		
125	XN125	125	2000->	1		0,8	CR8E	1275		
125	XT125R	125	2005->	1		0,8	CR7HSA	4549		
125	XT125X	125	2005->	1		0,8	CR7HSA	4549		
125	XV125	125	1997->	1		0,7	CR6HSA	2983		
125	YB125 B,C,E,F	125	1971->1976	1		0,7	B7HS	5110	BR7HS	4122
125	YBR125	125	2005->	1		0,7	CR6HSA	2983		
125	YBR125	125	2010->	1		0,8	CR6HSA	2983		
125	YP125XRX MAX	125	2006->	1		0,9	CPR9EA-9	2308		
125	YZ125	125	1974->1976	1		0,8	BR9EIX	3981	BR9ES	5722
125	YZ125	125	1985->	1		0,8	B9ES	2611	BR9ES	5722
125	YZ125	125	2006->	1		0,8	BR9EIX	3981	BR9ES	5722
125	YZ125	125	2006->	1		0,8	BR9EIX	3981	BR9ES	5722
125	YZ125	125	2013->	1		0,8	BR9EG	3230	BR9ES	5722
125	YZ125B,C,H,K,L	125	1996->1998	1		0,8	B9ES	2611	BR9ES	5722
125	YZ125E	125	1998->2005	1		0,8	BR9EG	3230	BR9ES	5722
125	YZ125N	125	1996->1998	1		0,8	B9ES	2611	BR9ES	5722
125	YZ125S	125	1996->1998	1		0,8	B9ES	2611	BR9ES	5722
125	YZ125T	125	1996->1998	1		0,8	B9ES	2611	BR9ES	5722
125	YZF-R125	125	2008->	1		0,8	CR8E	1275		
125	YZFR 125	125	2008->	1		0,8	CR8E	1275		
135	RD135	132	1978->	1		0,8	BPR8HS	3725		
175	AG175	175	1983->1985	1		0,8	B8ES	2411	BR8ES	5422
175	AG175H	175	1985->	1		0,8	B7ES	1111	BR7ES	5122
175	IT175,H,J,K	175	1983->1985	1		0,8	B9ES	2611	BR9ES	5722
176	DT180 AIR COOLED	176	1982->	1		0,8	BR8ES	5422		
176	TDR180	176	1982->1984	1		0,8	BR8ES	5422		
195	RS195	195	1978->	1		0,8	B7ES	1111	BR7ES	5122
200	AG200	200	1993->	1		0,7	D8EA	2120	DR8EA	7162
200	IT200	200	1984->1985	1		0,8	B9ES	2611	BR9ES	5722
200	IT200L	200	1984->1985	1		0,8	B9ES	2611	BR9ES	5722
200	IT200N	200	1984->1985	1		0,8	B9ES	2611	BR9ES	5722
200	IT200S	200	1984->1985	1		0,8	B9ES	2611	BR9ES	5722
200	NR200	200	1987->	1		0,8	B7ES	1111	BR7ES	5122
200	RD200B 12.7MM REACH	200	1983->1986	1		0,8	B8HS	5510	BR8HS	4322
200	RD200B 19.0MM REACH	200	1987->	1		0,8	B7ES	1111	BR7ES	5122
200	RD200C,C-DX,S	200	1976->	1		0,8	B7ES	1111	BR7ES	5122
200	TW200	200	1987->1999	1		0,7	DR8EA	7162		
200	TW200	200	2000->2010	1		0,7	DR8EA	7162		
200	WR200R,RE	200	1993->	1		0,8	BR9ES	5722		
200	XT200N	200	1982->1983	1		0,7	D8EA	2120	DR8EA	7162
200	XT200,J,K,KC	200	1982->1983	1		0,7	D8EA	2120	DR8EA	7162
200	YFS200E	200	1990->	1		0,8	B8ES	2411	BR8ES	5422
230	TTR230	230	2005->	1		0,7	DR8EA	7162		
250	MG250	250	1987->	1		0,8	BPR7ES	95164		
250	RZ250L	250	1979->1980	2		0,8	B8ES	2411	BR8ES	5422
250	RZ250N	250	1980->1988	2		0,8	B9ES	2611	BR9ES	5722
250	RZ250RR	250	1980->1988	2		0,8	B9ES	2611	BR9ES	5722
250	SR250	250	1980->1982	1		0,8	BPR7ES	95164		
250	TTR250	250	1999->2006	1		0,8	CR9E	6263		
250	TY250/E	250	1984->	1		0,8	B7ES	1111	BR7ES	5122
250	TZ250	250	1988->	2		0,6	B10ES	7928		
250	TZR250	250	1987->1989	2		0,8	B9ES	2611	BR9ES	5722
250	TZR250R	250	1993->	2		0,8	BR9ECM	3252		
250	TZR250T	250	1987->	2		0,8	B9ES	2611	BR9ES	5722
250	WR250	250	2013->	1		0,8	CR9EK	4548		
250	WR250 2,2E	250	1993->	2		0,8	B8EG	3430	B8ES	2411
250	WR250F	250	2001->2005	1		0,8	CR8E	1275		
250	WR250R	250	2008->	1		0,8	CR9EK	4548		
250	WR250X	250	2008->	1		0,8	CR9EK	4548		
250	XS250,C,H,RH,SE,SH	250	->1983	1		0,8	BPR7ES	95164		
250	XT250	250	2009->	1		0,8	DR7EA	7839		
250	XV250 VIRAGO	250	2006->	2		0,7	CR6HSA	2983		
250	YZ250	250	1996->2005	1		0,8	BR8EG	3130		
250	YZ250	250	1996->2005	1		0,8	BR8EG	3130		
250	YZ250 2T	250	2013->	1		0,8	BR8EG	3130		
250	YZ250 4T	250	2013->	1		0,8	CR8E	1275		



MOTOR CYCLES



Model	Type	Capacity	Year	Cyl	Engine	Gap	Recommended	Stock Code	Alternative	Stock Code
YAMAHA										
250	YZ250 FE	250	2014->	1		0,8	LMAR8G	95627		
250	YZ250 LC	250	2007->	1		0,8	BR8EG	3130		
250	YZ250E	250	1983->	1		0,8	B8EG	3430	B8ES	2411
250	YZ250F	250	2001->	1		0,8	CR8E	1275		
250	YZ250F	250	2001->2005	1		0,8	CR8E	1275		
250	YZ250N	250	1974->1981	1		0,8	B9ES	2611	BR9ES	5722
250	YZ250S	250	1995->	1		0,8	B8ES	2411	BR8ES	5422
250	YZ250T	250	1992->1994	1		0,8	B8ES	2411	BR8ES	5422
250	YZ250V	250	2006->	1		0,8	BR8EG	3130		
250	YZ250,E,H,J	250	1983->1983	1		0,8	B9ES	2611	BR9ES	5722
250	YZ250,K,L	250	1985->1986	1		0,8	B9ES	2611	BR9ES	5722
350	RD350J,LC	350	1984->	2		0,8	B8ES	2411	BR8ES	5422
350	RZ350K,L	350	->1985	2		0,8	B8ES	2411	BR8ES	5422
350	XT350	350	1985->	1		0,7	D8EA	2120	DR8EA	7162
350	XT350E	350	1981->	1		0,7	D8EA	2120	DR8EA	7162
350	XT350N	350	1985->	1		0,7	D8EA	2120	DR8EA	7162
350	XT350NC	350	1982->1983	1		0,7	D8EA	2120	DR8EA	7162
350	XT350S	350	1985->	1		0,7	D8EA	2120	DR8EA	7162
360	DT360	360	1973->1975	1		0,8	B9ES	2611	BR9ES	5722
360	DT360	360	1972->1973	1		0,8	B8ES	2411	BR8ES	5422
400	DT400E	400	1975->1976	1		0,8	B9ES	2611	BR9ES	5722
400	DT400MX	400	1975->1976	1		0,8	B9ES	2611	BR9ES	5722
400	DT400,H	400	1977->1979	1		0,8	B8ES	2411	BR8ES	5422
400	FZR400	400	1988-1990->	4		0,8	CR8E	1275		
400	IT400	400	1976->1979	1		0,8	B8ES	2411	BR8ES	5422
400	IT400E	400	1974->1975	1		0,8	B8ES	2411	BR8ES	5422
400	RD400	400	1976->1979	2		0,8	B8ES	2411	BR8ES	5422
400	RD400E	400	1976->1979	2		0,8	B8ES	2411	BR8ES	5422
400	XZ400	400	1971->1973	2		0,7	D8EA	2120	DR8EA	7162
400	YZ400,C,E	400	1976->1979	1		0,8	B8ES	2411	BR8ES	5422
425	IT425	425	1972->	1		0,8	B8ES	2411	BR8ES	5422
426	WR426F	426	2000->2002	1		0,8	CR8E	1275		
426	YZ426F	426	2000->	1		0,8	CR8E	1275		
450	WR450F	450	2003->2012	1		0,8	CR8E	1275		
450	WR450F	450	2013->	1		0,8	CR8E	1275		
450	YFZ450S	450	2004->	1		0,8	CR8E	1275		
450	YZ450F	450	2003->	1		0,8	CR8E	1275		
450	YZ450F	450	2003->2005	1		0,8	CR8E	1275		
465	IT465,H,J	465	1981->1982	1		0,8	B8ES	2411	BR8ES	5422
465	YZ465,H	465	1980->1981	1		0,8	B8ES	2411	BR8ES	5422
490	IT490	490	1984->	1		0,8	B8ES	2411	BR8ES	5422
490	IT490K	490	1983->	1		0,8	B8ES	2411	BR8ES	5422
490	IT490L	490	1983->1984	1		0,8	B8ES	2411	BR8ES	5422
490	YZ490	490	1984->	1		0,8	B8ES	2411	BR8ES	5422
490	YZ490	490	1985->	1		0,8	B9ES	2611	BR9ES	5722
490	YZ490J	490	1984->	1		0,8	B8ES	2411	BR8ES	5422
490	YZ490K,L	490	1984->1985	1		0,8	B9ES	2611	BR9ES	5722
490	YZ490N	490	1983->	1		0,8	B9ES	2611	BR9ES	5722
490	YZ490S	490	1985->	1		0,8	B9ES	2611	BR9ES	5722
490	YZ490T	490	1982->1987	1		0,8	B9ES	2611	BR9ES	5722
500	RD500LC	500	->1984	4		0,8	B9HS	5810	BR9HS	4522
500	RD500LC	500	1984->1987	4		0,8	BR9HS	4522		
500	SC500	500	1973->1974	1		0,8	B8ES	2411	BR8ES	5422
500	SR500	500	1978->1979	1		0,8	BPR7ES	95164		
500	SR500,E,H	500	1978->1979	1		0,8	BPR7ES	95164		
500	TT500,C,E,H,J	500	1976->1981	1		0,8	BPR7ES	95164		
500	TX500	500	1973->1974	1		0,7	D8EA	2120	DR8EA	7162
500	XP500 T MAX	500	2000->	1		0,8	CR7E	4578		
500	XT500	500	1976->1989	1		0,8	BPR7EIX	4055	BP7ES	95442
500	XT500,C,E,H	500	1977->1983	1		0,8	BPR7ES	95164		
550	XJ550K,L	550	1981->1983	4		0,7	D8EA	2120	DR8EA	7162
550	XJ550,H,J,RH,RJ	550	1982->	4		0,7	D8EA	2120	DR8EA	7162
550	XT550,K	550	1982->1983	1		0,7	D7EA	7912	DR7EA	7839
550	XZ550	550	1982->1983	4		0,7	D8EA	2120	DR8EA	7162
550	XZ550R,J,RK	550	1982->	4		0,7	D8EA	2120	DR8EA	7162
600	FZ6	600	2011->	4		0,8	CR9EK	4548		
600	FZ6 600	600	2004->2005	4		0,8	CR9EK	4548		
600	FZR600R	600	1999->	4		0,8	CR9E	6263		
600	FZS600 FAZER	600	1999->	4		0,8	CR8E	1275		
600	TT600	600	1984->	1		0,7	D7EA	7912	DR7EA	7839
600	TT600	600	1986->	1		0,9	DPR7EA-9	5129		
600	TT600N	600	1983->1985	1		0,9	DPR7EA-9	5129		

MOTORCYCLES



MOTOR CYCLES



Model	Type	Capacity	Year	Cyl	Engine	Gap	Recommended	Stock Code	Alternative	Stock Code
YAMAHA										
600	TT600S	600	1986->	1		0,9	DPR7EA-9	5129		
600	XJ6 600	600	2009->	4		0,8	CR9E	6263		
600	XT600E	600	1984->1993	1		0,9	DPR8EA-9	4929		
600	YZF-R6	600	2013->	4		0,8	CR10EK	2360		
600	YZF-R6 600	600	1999->2012	4		0,8	CR10EK	2360		
600	YZF600	600	2001->	1		0,8	CR9E	6263		
600	YZF600R	600	1995->2006	4		0,8	CR9E	6263		
600	YZF600R	600	1999->2006	4		0,8	CR9E	6263		
600	YZFR6 600	600	1999->2005	4		0,7	CR10EK	2360		
650	XJ650 LJ TURBO	650	1982->	4		0,8	BPR7ES	95164		
650	XJ650K,L	650	1980->1984	4		0,8	BPR7ES	95164		
650	XVS650-A	650	2006->	2		0,9	DPR7EA-9	5129		
660	MT 03	660	2006->	1		0,8	CR7E	4578		
660	XT660 Z TENERE	660	2008->	1		0,8	CR7E	4578		
660	XT660X	660	2006->	1		0,8	CR7E	4578		
660	XT660X,R	660	2004->	1		0,8	CR7E	4578		
700	MT-07 TRACER	700	2017->	2		0,9	LMAR8A-9S	6817		
750	FZ750N	750	1988->	4		0,9	DP8EA-9	5829	DPR8EA-9	4929
750	FZ750T	750	1985->1988	4		0,7	D8EA	2120	DR8EA	7162
750	FZR750R	750	1987->1989	4		0,9	DP8EA-9	5829	DPR8EA-9	4929
750	XJ750	750	1982->1984	4		0,8	BPR7ES	95164		
750	XJ750K	750	1981->1983	4		0,8	BPR7ES	95164		
750	XJ750MK,RK	750	1984->	4		0,8	BPR7ES	95164		
750	XJ750RL	750	1984->	4		0,8	BPR7ES	95164		
750	YZF750 R7	750	2000->	4		0,8	CR9E	6263		
850	MT-09 TRACER	850	2017->	3		0,9	CPR9EA-9	2308		
850	TDM850	850	1994->	1		0,9	DPR9EA-9	5329	DPR9EIX-9	5545
850	XSR900 60TH	850	2017->	3		0,9	CPR9EA-9	2308		
900	XJ900	900	1983->1994	4		0,8	BPR7ES	95164		
900	XJ900F	900	1983->1984	4		0,8	BPR7ES	95164		
900	XJ900S DIV	900	1995->2004	4		0,9	DPR8EA-9	4929		
900	XJ900S DIV	900	1995->2004	4		0,9	DPR8EA-9	4929		
900	XJ900,K,RL,P,FM,N	900	1983->1994	4		0,8	BPR7ES	95164		
950	XVS950A MIDNIGHT STAR	950	2009->	2		0,9	CPR8EA-9	2306		
950	XVS950A MIDNIGHT STAR	950	2009->	2		0,9	CPR8EA-9	2306		
1000	FZ1-S	1000	2011->	4		0,8	CR9EK	4548		
1000	FZ1 1000	1000	2006->	4		0,8	CR9EK	4548		
1000	FZR1000	1000	1987->1988	4		0,7	D8EA	2120	DR8EA	7162
1000	FZR1000	1000	1989->1993	4		0,8	DR8ESL	2923		
1000	FZR1000E	1000	1991->1996	4		0,7	DR8EA	7162		
1000	FZS1000 FAZER	1000	2001->	4		0,8	CR9E	6263		
1000	R1 YZF1000	1000	1998->	4		0,8	CR9E	6263		
1000	R1 YZF1000	1000	2002->	4		1	CR9EIX	3521	CR9E	6263
1000	R1 YZF1000	1000	2002->2003	4		0,9	CR9EIA-9	6289	CR9E	6263
1000	R1 YZF1000	1000	2004->2005	4		0,8	CR9EK	4548		
1000	R1 YZF1000	1000	2007->	4		0,8	CR9EK	4548		
1000	R1 YZF1000	1000	2007->2008	4		0,8	CR9EK	4548		
1000	R1 YZF1000	1000	2009->2012	4		0,8	LMAR9E-J	6884		
1000	R1 YZF1000.	1000	2004->	4		0,8	CR9EK	4548		
1000	YZF-R1	1000	2013->	4		0,7	LMAR9E-J	6884		
1100	FJ1100	1100	1984->1985	4		0,9	DPR8EA-9	4929		
1100	XS1100,E,H,S,SH,LH,RH	1100	1981->1984	2		0,8	BPR6ES	96989		
1100	XV1100	1100	2002->	2		0,8	BPR7ES	95164		
1100	XVS1100	1100	2000->	4		0,8	BR7ES	5122		
1100	XVS1100 V-STAR CLASSIC	1100	1999->2006	2		0,8	BPR7ES	95164		
1200	FJ1200	1200	1986->1993	4		0,9	DP8EA-9	5829	DPR8EA-9	4929
1200	FJ1200S	1200	1984->1985	4		0,9	DP8EA-9	5829	DPR8EA-9	4929
1200	FJ1200T	1200	1986->1993	4		0,9	DP8EA-9	5829	DPR8EA-9	4929
1200	VMX1200 V-MAX	1200	1985->2006	4		0,9	DPR8EA-9	4929		
1200	XT 1200 Z TENERE	1200	2010->	2		0,9	CPR8EB-9	6607		
1300	FJR1300	1300	2001->2005	4		0,8	CR8E	1275		
1300	FJR1300	1300	2013->	4		0,9	CPR8EA-9	2306		
1300	FJR1300 A	1300	2009->	4		0,8	CR8E	1275		
1300	V-STAR1300	1300	2007->	2		0,9	LMAR7A-9	4908		
1300	XJR1300 SP	1300	1999->	4		0,9	DPR8EA-9	4929		
1300	XVS 1300 A	1300	2007->	2		0,9	LMAR7A-9	4908		
1300	XVZ13C ROYAL STAR MIDNIGHT ADVENTURE	1300	2005->2006	2		0,9	DPR8EA-9	4929		
1300	XVZ13STD,TOURER	1300	2007->	2		0,9	DPR8EA-9	4929		
1600	XV1600	1600	1999->	2		0,9	DPR7EA-9	5129		
1700	1700 VMAX	1700	2009->2012	4		0,9	CR9EIA-9	6289	CR9E	6263
1700	XV1700 ROAD STAR	1700	2002->2005	2		0,9	DPR7EA-9	5129		
1900	XV1900 ROADLINE	1900	2010->	2		0,9	DPR8EA-9	4929		



SCOOTER



Model	Type	Capacity	Year	Cyl	Engine	Gap	Recommended	Stock Code	Alternative	Stock Code
APRILIA										
50	SCARABEO 50	50	2009->2014	1		0,8	ER9EH-N	95748		APRILIA
BAJAJ										
50	50 SPIRIT	50	1999->	1		0,8	B6HS	4510	BR6HS	3922
50	50 SUNNY	50	1996->	1		0,8	B6HS	4510	BR6HS	3922
125	125 CHETAK	125	1997->	1		0,8	BP6HS	4111		
BIG BOY										
125	125 F35	125	2011->	1		0,8	C7HSA	4629	CR7HSA	4549
125	125 REVIVAL	125	2011->	1		0,8	C7HSA	4629	CR7HSA	4549
125	125 SPORTFLITE	125	2011->	1		0,8	C7HSA	4629	CR7HSA	4549
125	125 T32	125	2011->	1		0,8	C7HSA	4629	CR7HSA	4549
150	CARGO 150	150	2011->	1		0,8	C7HSA	4629	CR7HSA	4549
150	F35 150	150	2011->	1		0,8	C7HSA	4629	CR7HSA	4549
150	POWERFLITE 150	150	2011->	1		0,8	C7HSA	4629	CR7HSA	4549
150	RETRO 150	150	2011->	1		0,8	C7HSA	4629	CR7HSA	4549
150	REVIVAL 150	150	2011->	1		0,8	C7HSA	4629	CR7HSA	4549
150	SPORTFLITE 150	150	2011->	1		0,8	C7HSA	4629	CR7HSA	4549
150	T32 150	150	2011->	1		0,8	C7HSA	4629	CR7HSA	4549
150	VANTAGE 150	150	2011->	1		0,8	C7HSA	4629	CR7HSA	4549
150	X7 150	150	2011->	1		0,8	C7HSA	4629	CR7HSA	4549
250	CITIFLITE 250	250	2011->	1		0,8	C7HSA	4629	CR7HSA	4549
BMW										
125	125	125	2000->	1		0,8	CR8EK	3478		BMW
200	C1 175	175	2001->	1		0,8	CR8EK	3478		
650	C 650 GT	650	2012->	2		0,8	LMAR8D-J	93444		
650	C 650 SPORT	650	2012->	2		0,8	LMAR8D-J	93444		
GOMOTO										
125	BALLISTIC 125	125	2011->	1		0,8	C7HSA	4629	CR7HSA	4549
125	CITTI 125	125	2011->	1		0,8	C7HSA	4629	CR7HSA	4549
125	NIPPI 125	125	2011->	1		0,8	C7HSA	4629	CR7HSA	4549
125	NIPPI BALLISTIC 125	125	2011->	1		0,8	C7HSA	4629	CR7HSA	4549
125	URBAN 125	125	2011->	1		0,8	C7HSA	4629	CR7HSA	4549
125	YESTERDAY I 125	125	2011->	1		0,8	C7HSA	4629	CR7HSA	4549
150	BALLISTIC 150	150	2011->	1		0,8	C7HSA	4629	CR7HSA	4549
150	CITTI 150	150	2011->	1		0,8	C7HSA	4629	CR7HSA	4549
150	NIPPI 150	150	2011->	1		0,8	C7HSA	4629	CR7HSA	4549
150	NIPPI BALLISTIC 150	150	2011->	1		0,8	C7HSA	4629	CR7HSA	4549
150	URBAN BALLISTIC 150	150	2011->	1		0,8	C7HSA	4629	CR7HSA	4549
150	YESTERDAY SI 150	150	2011->	1		0,8	C7HSA	4629	CR7HSA	4549
HONDA										
50	F5A,E DIO FSE 50	50	1994->	1		0,8	B8HS	5510	BR8HS	4322
50	GS7E 50	50	1990->	1		0,7	BR4HS	3322		
50	KA50A	50	1992->1993	1		0,8	BR6HS	3922		
50	T5Q TACT 50	50	1990->1991	1		0,6	BP6HS	4511	BPR6HS	7022
100	100 LEAD	100	2008->	1		0,9	CR8EH-9	5666		
100	100 LEAD SCV	100	2003->	1		0,8	CR6HSA	2983		
125	125 S-WING	125	2007->	1		0,9	CR8EH-9	5666		
125	ANF125 INNOVA	125	2007->	1		0,9	CPR6EA-9S	1582		
125	L125S DIFA	125	2005->	1		0,6	BP6HS	4511	BPR6HS	7022
125	PCX 125	125	2010->	1		0,8	CPR8EA-9	2306		
150	150 S-WING	150	2007->	1		0,9	CR8EH-9	5666		
250	250 FORZA	250	2005->	1		0,9	DPR7EA-9	5129		
250	250 FORZA X,EX	250	2009->	1		0,9	LMAR8AI-8	92288		
300	SH 300	300	2007->	1		0,9	LMAR8AI-8	92288		
400	SW-T 400	400	2009->	1		0,9	CR8EH-9	5666		



SCOOTER



Model	Type	Capacity	Year	Cyl	Engine	Gap	Recommended	Stock Code	Alternative	Stock Code
JONWAY										
110	SPIRIT 110	110	2011->	1		0,8	C7HSA	4629	CR7HSA	4549
125	ADVENTURE 125	125	2011->	1		0,8	C7HSA	4629	CR7HSA	4549
125	EL NINJO 125	125	2011->	1		0,8	C7HSA	4629	CR7HSA	4549
125	GALACTICA 125	125	2011->	1		0,8	C7HSA	4629	CR7HSA	4549
125	SPIRIT 125	125	2011->	1		0,8	C7HSA	4629	CR7HSA	4549
125	SPRAY 125	125	2011->	1		0,8	C7HSA	4629	CR7HSA	4549
125	VETERANO 125	125	2011->	1		0,8	C7HSA	4629	CR7HSA	4549
150	ADVENTURE 150	150	2011->	1		0,8	C7HSA	4629	CR7HSA	4549
150	EL NINJO 150	150	2011->	1		0,8	C7HSA	4629	CR7HSA	4549
150	GALACTICA 150	150	2011->	1		0,8	C7HSA	4629	CR7HSA	4549
150	SPRAY 150	150	2011->	1		0,8	C7HSA	4629	CR7HSA	4549
150	VETERANO 150	150	2011->	1		0,8	C7HSA	4629	CR7HSA	4549
250	MASTER 250	250	2011->	1		0,8	D8EA	2120	DR8EA	7162
300	MASTER 300	300	2011->	1		0,8	D8EA	2120	DR8EA	7162

KYMCO										
125	SUPER 8 125	125	2008->	1		0,8	CR7HSA	4549		
125	DOWNTIME 125	125	2009->	1		0,8	CR7E	4578		
125	LIKE 125	125	2009->	1		0,8	CR7HSA	4549		
150	AGILITY 150 R16	150	2008->	1		0,8	CR7HSA	4549		
150	DINK 200 DD	150	2008->	1		0,9	DPR6EA-9	5531		
200	DOWNTOWN 200	200	2009->	1		0,8	CR7E	4578		
200	LIKE 200	200	2009->	1		0,8	CR7HSA	4549		
300	DOWNTOWN 300	300	2009->	1		0,8	CR7E	4578		
300	EXCITING 300	300	2009->	1		0,9	DPR6EA-9	5531		
500	500 EXCITING	500	2009->	1		0,8	CR7E	4578		

PGO										
50	50 G-MAX	50	2004->	1		1	BPR7HS-10	1092		
125	125 G-MAX	125	2005->	1		0,8	C7HSA	4629	CR7HSA	4549
150	150 T-REX	150	2003->	1		0,8	C7HSA	4629	CR7HSA	4549

PIAGGIO (VESPA)										
50	LX50 4T 4V	50	2010->	1		0,6	ER9EH	5869		
50	LIBERTY 50	50	2017->	1		0,8	MR8BI-8	91360		
50	ZIP 50	50	2018->	1		0,8	MR8BI-8	91360		
90	BIG MAX 90	90	1994->	1		0,7	BP7HS	5111		
90	PMX 90	90	1994->1995	1		0,7	BP7HS	5111		
90	TORNADO 90	90	1992->1999	1		0,7	BP7HS	5111		
110	PMX 110	110	1998->	1		0,7	BP7HS	5111		
125	GTS SUPER 125	125	2010->	1		0,8	CR8EK	3478		
125	T-REX 125	125	1995->1998	1		0,8	CR7HSA	4549		
125	VESPA 125GT, 125GTR	125	1984->1989	1		0,6	B6HS	4510	BR6HS	3922
125	VESPA 125,P125X,SUPER	125	1982->1984	1		0,6	B6HS	4510	BR6HS	3922
150	VESPA 150E,S,X,SPRINT	150	2008->	1		0,6	B6HS	4510	BR6HS	3922
150	VESPA SUPER SPRINT VELOCE 150	150	2001->2004	1		0,6	B6HS	4510	BR6HS	3922
185	VESPA RALLY 180SS	185	1999->	1		0,5	B6ES	7310	BP6ES	91076
200	VESPA P200E, PX200E	200	2001->	1		0,5	B6ES	7310	BP6ES	91076
300	VESPA ET3 APECER-MP 300	300	1998->	1		0,7	B7HS	5110	BR7HS	4122

PUZEY										
125	JET 125	125	2011->	1		0,8	C7HSA	4629	CR7HSA	4549
125	XOR 125	125	2011->	1		0,8	C7HSA	4629	CR7HSA	4549
150	CLASSIC 150	150	2011->	1		0,8	C7HSA	4629	CR7HSA	4549

SUZUKI										
100	FB100 ,G	100	1989->1995	1		0,7	C6HSA	3228	CR6HSA	2983
110	110 LETS	110	2014->	1		0,9	MR7E-9	92474		

SYMCO										
115	MIO 115	115	2017->	1		0,8	LR7D	90072		



SCOOTER



Model	Type	Capacity	Year	Cyl	Engine	Gap	Recommended	Stock Code	Alternative	Stock Code
VUKA										
90	EL 90	90	2011->	1		0,8	C7HSA	4629	CR7HSA	4549
110	XL 110	110	2011->	1		0,8	C7HSA	4629	CR7HSA	4549
125	XRI 125	125	2011->	1		0,8	C7HSA	4629	CR7HSA	4549
150	XTi 150	150	2011->	1		0,8	C7HSA	4629	CR7HSA	4549

YAMAHA										
100	YQ100	100	2002->2006	1		0,8	BR8HS	4322		
125	NXC125	125	2005->2012	1		0,8	CR7E	4578		
125	XC125	125	1995->	1		0,8	CR7E	4578		
125	XC125E	125	1990->	1		0,7	CR6HSA	2983		
125	XC125S	125	1992->1996	1		0,7	C6HSA	3228	CR6HSA	2983
125	XC125SC	125	1985->2001	1		0,7	C6HSA	3228	CR6HSA	2983
125	XC125X	125	1992->1996	1		0,7	C6HSA	3228	CR6HSA	2983
125	XC125ZS	125	1985->2001	1		0,7	C6HSA	3228	CR6HSA	2983
125	XC125ZSC	125	1985->2001	1		0,7	C6HSA	3228	CR6HSA	2983
250	250 BLACK X-MAX	250	2009->	1		0,9	DPR8EA-9	4929		
250	CP250 MORPHOUS	250	2006->	1		0,9	CPR8EA-9	2306		
530	TMAX	530	2010->	1		0,8	CR7E	4578		

SCOOTERS



MARINE • INBOARD



Model	Type	Capacity	Year	Cyl	Engine	Gap	Recommended	Stock Code	Alternative	Stock Code
-------	------	----------	------	-----	--------	-----	-------------	------------	-------------	------------

BMW										
130	G130-1					0,8	BPR6ES	96989		
130	G130-S					0,8	BPR6ES	96989		
190	B190					0,8	BPR5ES	94084		
190	G190-1					0,8	BPR5ES	94084		
190	G190-S					0,8	BPR5ES	94084		
220	B220					0,8	BPR5ES	94084		
220	G220-1					0,8	BPR5ES	94084		
220	G220-S					0,8	BPR5ES	94084		
800	G800					0,6	B6HS	4510	BR6HS	3922

CHRYSLER VOLVO										
110						0,7	B7HS	5110	BR7HS	4122
115						0,7	B7HS	5110	BR7HS	4122
120						0,7	B7HS	5110	BR7HS	4122
130						0,7	B7HS	5110	BR7HS	4122
165						0,7	B7HS	5110	BR7HS	4122
170						0,7	B7HS	5110	BR7HS	4122

MERCUISER										
110						0,8	BPR6ES	96989		
120					SER.NO.3825578	0,8	BPR6ES	96989		
120					SER.NO.3825579	0,8	BP6FS	3512	BPR6FS	2623
140	140-4				SER.NO.3826282	0,8	BPR6ES	96989		
140	140-4				SER.NO.3826283	0,8	BP6FS	3512	BPR6FS	2623
140	140-6					0,8	BPR6ES	96989		
150						0,8	BPR6ES	96989		
160						0,8	BPR6ES	96989		
165					SER.NO.2771483	0,8	BPR6ES	96989		
185						0,8	BP6FS	3512	BPR6FS	2623
190						0,7	B6S	3510		
200						0,8	BPR6ES	96989		
215						0,8	AP6FS	2710	APR6FS	2922
225		2006->				0,8	BPR6FS	2623		
225					SER.NO.2278646	0,8	B7S	3710		
225					SER.NO.2278647-> 3385720	0,7	B6S	3510		
225					SER.NO.3385721	0,8	AP6FS	2710	APR6FS	2922
228	TR					0,8	BR6FS	4323		
228						0,8	BP6FS	3512	BPR6FS	2623
233	14MM HEADS					0,8	BP5FS	3412		
233	18MM HEADS					0,8	AP6FS	2710	APR6FS	2922
250						0,8	BP6FS	3512	BPR6FS	2623
255					SER. NO.4175499	0,8	AP6FS	2710	APR6FS	2922
255					SER. NO.4175500	0,8	BP5FS	3412		
260						0,8	BP6FS	3512	BPR6FS	2623
310						0,8	B7ES	1111	BR7ES	5122
315	315					0,7	B7EM	3321		
325					SER. NO.3043030	0,8	BR6FS	4323		
330	TR,TRS					0,8	BP6FS	3512	BPR6FS	2623
370						0,8	BP6FS	3512	BPR6FS	2623
400						0,8	BP6FS	3512	BPR6FS	2623
470						0,8	BP6FS	3512	BPR6FS	2623
GM	5.7 MPI	5700	2008->			1,5	ITR4A-15	5599		
GM	6.2 L MX MPI	6200	2002->2007			1,5	ITR4A-15	5599		
GM	BLACK SCORPION	6200	2003->2007			1,5	ITR4A-15	5599		
GM	SCORPION 350		2008->			1,5	ITR4A-15	5599		
GM	SCORPION 377		2008->			1,5	ITR4A-15	5599		

NISSAN										
110	HA110 H20					0,6	B5ES	6410		
115	GA115 G20					0,6	B5ES	6410		
135	GA135 G20					0,5	B6ES	7310	BP6ES	91076
145	HA145 H30					0,8	B7ES	1111	BR7ES	5122
170	HA170 H30					0,8	B7ES	1111	BR7ES	5122
190	YA190 Y44					0,8	BPR5ES	94084		

ABARTH

MARINE



MARINE • INBOARD



Model	Type	Capacity	Year	Cyl	Engine	Gap	Recommended	Stock Code	Alternative	Stock Code
VOLVO-PENTA						VOLVO-PENTA				
2	MB2					0,6	D6HS	6812		
10	MB10A					0,6	BP6HS	4511	BPR6HS	7022
16	MB16A					0,7	B6S	3510		
20	MB20A					0,6	BP6HS	4511	BPR6HS	7022
20	MB20B					0,5	B4H	4110		
20	MB20C					0,5	B4H	4110		
125	AQ125A					0,8	BPR6ES	96989		
130	AQ130					0,8	BPR7ES	95164		
150	AQ150					0,8	BP6S	3111		
170	AQ170					0,7	BP7HS	5111		
210	AQ210A				ENG. NO. 177314	0,7	B6S	3510		
210	AQ210A				ENG. NO. 177315	0,8	BP6FS	3512	BPR6FS	2623
225	AQ225					0,8	BP6FS	3512	BPR6FS	2623



JET SKI



Model	Type	Capacity	Year	Cyl	Engine	Gap	Recommended	Stock Code	Alternative	Stock Code
AQUAJET										
1250	WX-1	1250	2001->2002			0,8	BR8ES	5422		AQUAJET
ARCTCO										
640	TIGERSHARK TS640,MONTEGO,L	640				0,8	BR9ES	5722		ARCTCO
770	TIGERSHARK TS770,DAYTONA,R,L	770				0,8	BR9ES	5722		
1000	TIGERSHARK TS1000,DAYTONA,R,L	1000				0,8	BR9ES	5722		
TIGERSHARK	MONTE CARLO	770				0,8	BR9ES	5722		
ARCTIC CAT										
TIGER SHARK	1000	1000	1998->			0,8	BR9ES	5722		ARCTIC CAT
TIGER SHARK	770	770	1998->1999			0,8	BR9ES	5722		
TIGER SHARK	900	900	1999->			0,8	BR9ES	5722		
BOMBARDIER										
580	GTS	580	1992->1997			0,8	BR7ES	5122		BOMBARDIER
580	SP	580	1991->1997			0,8	BR7ES	5122		
580	SPI	580	1993->1997			0,8	BR7ES	5122		
718	GTI	718	2004->2005			1,1	BR8ES-11	7986		
718	HX	718	1995->1997			0,8	BR8ES	5422		
718	SPX	718	1996->1997			0,8	BR8ES	5422		
787	GSX787,GTX787	787				0,8	BR8ES	5422		
800	XP	800				0,8	BR8ES	5422		
947	GTX DI	947	2007->			1,1	ZFR5F-11	93814		
950	XP DI STD	950	2004->			1,1	ZFR5F-11	93814		
951	GTX	951	2000->2003			1,1	ZFR5F-11	93814		
951	LRV DI	951	2002->2003			1,1	ZFR5F-11	93814		
951	RX DI	951	2000->2003			1,1	ZFR5F-11	93814		
1500	RXP,RXT	1500	2007->			0,8	DCPR8E	4339		
1503	GTI 4 TEC	1503	2007->2008			0,8	DCPR8E	4339		
5599,6115,6162,6163	BULLET	550	2004->			0,8	DCPR8E	4339		
6135,614	GTI LE	718	2004->			0,8	BR8ES	5422		
6137,614	GTI-RFI STD	782	2004->			0,8	BR8ES	5422		
6141,614	GTX4-TEC LTD	1494	2004->			0,8	DCPR8E	4339		
6147,615	GTX4 TEC STD	1494	2004->			0,8	DCPR8E	4339		
6151,615	XP-DISTD	781	2004->			1,1	ZFR5F-11	93814		
6157	BARRACUDA,PREMIUM	782	2004->			0,8	BR8ES	5422		
6158	BARACUDA,PREMIUM	782	2004->			0,8	BR8ES	5422		
GTI 6133,6134	STD,LE,RFI	720	2004->			0,6	BR8ES	5422		
HONDA										
1200	AQUA TRAX F-12	1200	2002->	4		0,9	IMR9D-9H	6544	CR9EH-9	7502
1200	ARX1200N2T2	1200	2004->2004	4		0,9	IMR9D-9H	6544	CR9EH-9	7502
1200	ARX1200N3T3	1200	2002->2004	4		0,9	IMR9D-9H	6544	CR9EH-9	7502
KAWASAKI										
400	JS 400A	400	1974->1975			0,8	B8ES	2411	BR8ES	5422
550	JS, SX 550	550	1982->1995			0,8	BR8ES	5422		
750	JS 750 SXI PRO	750	2003->			0,8	BR8ES	5422		
750	JT750 SX1PRO	750	2003->			0,8	BR8ES	5422		
800	JS 800SX-R	800	2003->			0,8	BR9ES	5722		
800	SX R 800 JS 800A	800	2003->2008			0,8	BR8ES	5422		
900	STX 900	900	2001->2006			0,8	BR9ES	5722		
1100	STX 1100	1100	1997->1999			0,8	BR9ES	5722		
1100	STX1100DI	1100	2002->			0,8	BR9ES	5722		
1100	STX1100DI C1,F1	1100	2000->			0,8	ZFR7F	5913		
1200	JH ULTRA 150	1200	2004->	4		0,8	BR9ES	5722		
1200	STX 12F JT 1200B	1200	2003->2007			0,8	CR9EK	4548		
1200	STX R JT1200C	1200	2004->2005			0,8	BR9ES	5722		
1200	STX1200 12F	1200	2003->			0,8	CR9EK	4548		
1200	STX1200F	1200	2004->			0,8	CR9EK	4548		
1200	STX1200R	1200	2002->			0,8	BR9ES	5722		
1300	130 DI		2001->2004			0,8	ZFR7F	5913		
1500	JT1500 AEF	1500	2014->	4		0,8	CR9EB	6955		
1500	STX	1500	2004->			0,8	CR9EK	4548		
1500	STX-15F	1500	2004->2008			0,8	CR9EK	4548		
1500	ULTRA 250X	1500	2007->			0,7	PMR9B	4717	CPR9EA-9	2308
1500	ULTRA LX JT1500C7F	1500	2007->2008			0,8	CR9EK	4548		



JET SKI



Model	Type	Capacity	Year	Cyl	Engine	Gap	Recommended	Stock Code	Alternative	Stock Code
POLARIS										
700	VIRAGE	700	2000->2004			0,8	BPR8ES	3923		
701	FREEDOM	701	2002->2004			0,8	BPR8ES	3923		
701	VIRAGE	701	2000->2004			0,8	BR8ES	5422		
750	MSX110	750	2004->			0,8	BCPR7E	1272		
750	MSX150	750	2004->			0,8	BCPR7E	1272		
750	MSX750	750	2004->			0,8	BCPR7E	1272		
777	OCTANE	777	2002->2004			0,8	BR9ES	5722		
777	OCTANE	777	2002->2004			0,8	BR9ES	5722		
777	VIRAGE	777	2002->2004			1,1	IZFR6H-11	4294	ZFR6F-11	93208
1165	GENESIS	1165	1999->2004			0,8	PZFR6H	7696		
1165	VIRAGE INJECTION	1165	2001->			0,8	PZFR6H	7696		
1192	MX140 JET SKI	1192	2003->2004			0,8	PZFR6H	7696		

SEA-DOO										
610	BARRACUDA PREMIUM SP 6157/6158	610	2004->			0,8	B8ES	2411	BR8ES	5422
718	GTI 718LE,LE RFI	718	2003->			0,8	BR8ES	5422		
720	GTI STD,LE,RFI	720	2004->			0,8	BR8ES	5422		
947	GTX947DI	947	2000->			1,1	ZFR5F-11	93814		
947	RX947	947	2000->			1,1	ZFR5F-11	93814		
951	GTX951DI	951	2000->			1,1	ZFR5F-11	93814		
951	RX951DI	951	2003->			1,1	ZFR5F-11	93814		
951	XP951LTD DI	951	2004->			1,1	ZFR5F-11	93814		
1630	GTX LTD 300	1630	2018->	3		0,8	KR9E-G	93226		

YAMAHA										
500	WJ500 WAVE JAMMER 500	500	1987->1990			1	BR7HS-10	1098		
500	WR500 WAVE RUNNER 500	500	1987->1994			1	BR7HS-10	1098		
650	SJ650 SUPER JET	650	1990->1994			1	BR8HS-10	1134		
650	WR650 WAVE RUNNER 650	650	1990->1992			1	BR8HS-10	1134		
650	WR650A WAVE RUNNER 650A	650	1990->1993			1	BR8HS-10	1134		
700	MARINE JET FX,XJ,VN700	700	1995->1997			0,8	BR8HS	4322		
700	SUPER JET SJ700	700	1998->			0,7	B7HS	5110	BR7HS	4122
700	WB700	700	1993->1996			1	BR8HS-10	1134		
700	WRA WAVE RUNNER	700	1995->1997			0,8	BR8HS	4322		
760	MARINE JET RA,GP760	760	1996->1999			0,8	BR8HS	4322		
800	MARINE JET GP800	800	1998->			0,8	BR8HS	4322		
800	WB800	800	1999->2002			0,8	BR8ES	5422		
800	XL800	800	2000->			0,8	BR9ES	5722		
800	XLT800	800	2002->			0,8	BR8ES	5422		
1000	FX1000	1000	2003->			0,8	CR9EB	6955		
1000	WAVE RUNNER 1000	1000	2002->2008			0,8	CR9EB	6955		
1100	MARINE JET RA1100	1100	1995->1997			0,8	BR8HS	4322		
1100	VX DELUXE	1100	2008->			0,8	CR9EB	6955		
1100	VX SPORT VX1100CB	1100	2005->			0,8	CR9EB	6955		
1100	VX1100G	1100	2008->			0,8	CR9EB	6955		
1200	GP R	1200	2000->			1,1	BR8ES-11	7986		
1200	GP1200	1200	2003->			1,1	BR8ES-11	7986		
1200	MARINE JET GP1200	1200	2003->			0,8	BR8HS	4322		
1200	XLT1200	1200	2001->			1,1	BR8ES-11	7986		
1300	GPR1300	1300	2003->			1,1	BR8ES-11	7986		
1300	WAVE RUNNER GP GP1300	1300	2003->2008			1,1	BR8ES-11	7986		
1800	FX1800A-J	1800	2010->			1,1	LFR6A-11	3672		
1800	FX1800J	1800	2010->			1,1	LFR6A-11	3672		
1800	FZS1800		2013->	4	JF180RNCE	0,8	LFR7AIX-P	2900	LFR7A	92038
1800	GX1800A-H	1800	2009->			0,8	LFR6A-11	3672		
1800	GX1800H	1800	2009->			0,8	LFR6A-11	3672		



MARINE • OUTBOARD



Model	Type	Capacity	Year	Cyl	Engine	Gap	Recommended	Stock Code	Alternative	Stock Code
AERO										
4HP	4HP		1970>1973		AM4000	0,8	BP5S	3011		
5HP	5HP		1970>1972		AM5000 / E	0,8	B6L	3212		
7.5HP	7.5HP		1970>1973		AM7500	0,8	BM6A	5921	BMR6A	7421
9HP	9HP		1971>1973		AM9000	0,8	BM6A	5921	BMR6A	7421
BMW										
130	130 HP				B130	0,8	BPR6ES	96989		
BRIGGS & STRATON										
5.0	5.0 HP				OHV AIR COOLED	0,8	BKR5ES	90841		
BRITISH SEAGULL										
ALL MODELS			1955>1981			0,6	AB-6	2910		
QB SERIES						0,8	B7ES	1111	BR7ES	5122
CARNITI										
3.5	3.5 HP					0,5	B5HS	4210		
8	8 HP					0,5	B5HS	4210		
15	15 HP					0,8	B8HS	5510	BR8HS	4322
18	18 HP					0,8	B8HS	5510	BR8HS	4322
20	20 HP					0,6	B6HS	4510	BR6HS	3922
25	25 HP					0,5	B5HS	4210		
28	28 HP				OCN	0,8	B8HS	5510	BR8HS	4322
45	45 HP				S	0,8	B9HS	5810	BR9HS	4522
45	45 HP					0,8	B8HS	5510	BR8HS	4322
55	55 HP					0,8	B8HS	5510	BR8HS	4322
65	65 HP				S	0,8	B9HS	5810	BR9HS	4522
65	65 HP					0,8	B8HS	5510	BR8HS	4322
80	80 HP				S	0,8	B9HS	5810	BR9HS	4522
80	80 HP					0,8	B8HS	5510	BR8HS	4322
90	90 HP					0,8	B8HS	5510	BR8HS	4322
100	100 HP					0,8	B8HS	5510	BR8HS	4322
700	700 HP				SPORT	0,8	B8HS	5510	BR8HS	4322
850	850 HP				SPORT	0,8	B8HS	5510	BR8HS	4322
1000	1000 HP				SPORT	0,8	B8HS	5510	BR8HS	4322
CHRYSLER										
3.5	3.5 HP		1980>1984			0,6	B6HS	4510	BR6HS	3922
4	4 HP		1976>1985			0,6	B6HS	4510	BR6HS	3922
4.4	4.4 HP		1968>			0,8	BR6HS	3922		
4.9	4.9 HP		1973>1975			0,8	BP5HS	4111		
5.0	5.0 HP		1969>1970			0,8	BR6HS	3922		
6	6 HP		1978>1982			0,6	B6HS	4510	BR6HS	3922
7.5	7.5 HP		1978>1984			0,6	B6HS	4510	BR6HS	3922
8	8 HP		1978>			0,6	B6HS	4510	BR6HS	3922
9.9	9.9 HP		1979>1985			0,7	B7HS	5110	BR7HS	4122
10	10 HP		1974>1978			0,7	B7HS	5110	BR7HS	4122
12	12 HP		1979>			0,7	B7HS	5110	BR7HS	4122
15	15 HP		1974>1985			0,7	B7HS	5110	BR7HS	4122
20	20 HP		1979>1983			0,7	B7HS	5110	BR7HS	4122
25	25 HP		1973>1984			0,7	B7HS	5110	BR7HS	4122
30	30 HP		1979>1982			0,7	B7HS	5110	BR7HS	4122
35	35 HP		1968>1984			0,7	B7HS	5110	BR7HS	4122
45	45 HP		1968>1984			0,7	B7HS	5110	BR7HS	4122
45	45 HP		1971>1978		MAGNAPOWER	0	BUH	2422		
50	50 HP		1981>		ECONOMATE	0,7	B7HS	5110	BR7HS	4122
50	50 HP		1982>1985			0,7	B7HS	5110	BR7HS	4122
55	55 HP		1969>1981		MAGNAPOWER	0	BUH	2422		
65	65 HP		1977>1978		MAGNAPOWER	0	BUH	2422		
70	70 HP		1979>		70 HP	0	BUH	2422		
70	70 HP		1980>		SKIER 700	0	BUH	2422		
75	75 HP		1974>1984		MAGNAPOWER	0	BUH	2422		
85	85 HP		1978>1986		MAGNAPOWER	0	BUH	2422		
90	100 HP		1983>1984		MAGNAPOWER	0	BUH	2422		
100	100 HP		1980>1984		MAGNAPOWER	0	BUH	2422		
105	105 HP		1982>1983		MAGNAPOWER	0	BUH	2422		
115	115 HP		1978>1984		MAGNAPOWER	0	BUH	2422		



MARINE • OUTBOARD



Model	Type	Capacity	Year	Cyl	Engine	Gap	Recommended	Stock Code	Alternative	Stock Code
CHRYSLER										
125	125 HP		1981->1985		MAGNAPOWER	0	BUH	2422		CHRYSLER
140	140 HP		1978->1984		MAGNAPOWER	0	BUH	2422		
EVINRUDE										
1.6	1.6 HP				115-SD	1	B9HS-10	3626	BR9HS-10	4551
1.8	1.8 HP				140-SD	1	B9HS-10	3626	BR9HS-10	4551
2	2 HP		1975->1980			0,7	B6S	3510		
2.6	2.6 HP				190-SD	1	B9HS-10	3626	BR9HS-10	4551
2.7	2.7 HP				L225-SD	1	B9HS-10	3626	BR9HS-10	4551
3.5	3.5 HP		2001->			0,8	BPR6HS	7022		
3.6	3.6 HP				L275-SD	1	B9HS-10	3626	BR9HS-10	4551
4	4 HP		1977->1980			1	B9HS-10	3626	BR9HS-10	4551
4	4 HP		1981->1986			0,6	B6HS	4510	BR6HS	3922
4	4 HP		1987->		CDI	1	B9HS-10	3626	BR9HS-10	4551
4	4 HP		1987->		MAG	0,6	B6HS	4510	BR6HS	3922
4.5	4.5 HP		1979->1983			1	B9HS-10	3626	BR9HS-10	4551
6	6 HP		1978->1979			0	BUHW-2	5626		
6	6 HP		1984->1986			1	B9HS-10	3626	BR9HS-10	4551
7.5	7.5 HP		1980->1983			1	B9HS-10	3626	BR9HS-10	4551
8	8 HP		1984->1987			1	B9HS-10	3626	BR9HS-10	4551
9.9	9.9 HP		1978->1979			0	BUHW-2	5626		
9.9	9.9 HP		1978->1983		SAIL DRIVE	1	B9HS-10	3626	BR9HS-10	4551
9.9	9.9 HP		1980->1987			1	B9HS-10	3626	BR9HS-10	4551
10	10 HP		1981->1982		COMMERCIAL	0	BUHW-2	5626		
14	14 HP		1981->		COMMERCIAL	0	BUHW-2	5626		
15	15 HP		1978->1979			0	BUHW-2	5626		
15	15 HP		1980->1987			1	B9HS-10	3626	BR9HS-10	4551
15	15 HP		1981->1984		SAIL DRIVE	1	B9HS-10	3626	BR9HS-10	4551
20	20 HP		1985->1987			1	B9HS-10	3626	BR9HS-10	4551
25	25 HP		1978->1986			1	B9HS-10	3626	BR9HS-10	4551
25	25 HP		2003->2005			1	BPZ8HS-10	3133		
25	25 HP		2009->		E25DEL	1,1	IZFR6F-11	4095		
28	25 HP		1987->			1	B9HS-10	3626	BR9HS-10	4551
30	25 HP		1984->1986			1	B9HS-10	3626	BR9HS-10	4551
30	30 HP		2009->		E30DEL	1,1	IZFR6F-11	4095		
30	30 HP		2009->		E30DPL	1,1	IZFR6F-11	4095		
35	25 HP		1977->1987			1	B9HS-10	3626	BR9HS-10	4551
40	40 HP		1981->1987			1	B9HS-10	3626	BR9HS-10	4551
40	40 HP		1982->		COMMERCIAL	0,7	B7HS	5110	BR7HS	4122
40	40 HP		1982->			0,7	B7HS	5110	BR7HS	4122
40	40 HP		1984->1987		COMMERCIAL	0	BUHW-2	5626		
40	40 HP		2004->2005			0,8	PZFR6H	7696		
40	40 HP		2007->		E40DPLSUM	0,8	IZFR6N-E	4757		
40	40 HP		2007->		E40DRLSUM	0,8	IZFR6N-E	4757		
40	40 HP		2008->		E40DRLSCB	1,1	IZFR6F-11	4095		
40	40 HP		2008->		E40DSLSCS	1,1	IZFR6F-11	4095		
40	40 HP		2008->		E40DTLSCS	1,1	IZFR6F-11	4095		
40	40 HP		2009->		E40DP	1,1	IZFR6F-11	4095		
40	40 HP		2009->		E40DPLSEE	1,1	IZFR6F-11	4095		
40	40 HP		2009->		E40DRLSEE	1,1	IZFR6F-11	4095		
40	40 HP		2009->		E40DSLSEC	1,1	IZFR6F-11	4095		
48	48 HP		1987->			1	B9HS-10	3626	BR9HS-10	4551
50	50 HP		1978->1983			1	B9HS-10	3626	BR9HS-10	4551
50	50 HP		2008->		E50DSLSCS	1,1	IZFR6F-11	4095	ZFR6F-11	93208
55	55 HP		1976->1983		COMMERCIAL	1	B9HS-10	3626	BR9HS-10	4551
55	55 HP		1982->		COMMERCIAL	1	B9HS-10	3626	BR9HS-10	4551
55	55 HP		1984->1985		COMMERCIAL	1	B9HS-10	3626	BR9HS-10	4551
55	55 HP		1986->		COMMERCIAL	0	BUHW-1	5526		
55	55 HP		1987->		COMMERCIAL	0	BUHW-2	5626		
60	60 HP		1980->1985			1	B9HS-10	3626	BR9HS-10	4551
60	60 HP		2005->			0,8	PZFR6H	7696		
65	65 HP		1984->1986		COMMERCIAL	1	B9HS-10	3626	BR9HS-10	4551
65	65 HP		1987->		COMMERCIAL	0	BUHW-2	5626		
70	70 HP		1975->1987			1	B9HS-10	3626	BR9HS-10	4551
75	75 HP		1975->		HUSTLER	1	B9HS-10	3626	BR9HS-10	4551
75	75 HP		1976->1985			1	B9HS-10	3626	BR9HS-10	4551
75	75 HP		2001->2005			0,8	BKR5EK	90426		
85	85 HP		1975->1980			1	B9HS-10	3626	BR9HS-10	4551
90	90 HP		1981->1987			1	B9HS-10	3626	BR9HS-10	4551
90	90 HP		2000->		V4 EFI	0,8	PZFR6H	7696		
90	90 HP		2001->2005			0,8	BKR5EK	90426		



MARINE • OUTBOARD



Model	Type	Capacity	Year	Cyl	Engine	Gap	Recommended	Stock Code	Alternative	Stock Code
EVINRUDE										
100	100 HP		1979->1980			1	B9HS-10	3626	BR9HS-10	4551
100	100 HP		1984->		COMMERCIAL	0	BUHW	2622		
100	100 HP		1985->1987		COMMERCIAL	0	BUHW-2	5626		
100	100 HP		2004->2005			0,8	BKR5EK	90426		
100	100 HP DI	100	2004->2005	4		0,8	PZFR6H	7696		
110	110 HP		1986->1987			1	B9HS-10	3626	BR9HS-10	4551
115	115 HP		1975->1984			1	B9HS-10	3626	BR9HS-10	4551
115	115 HP		1985->			0	BUHW	2622		
115	115 HP		2004->2005			0,8	BKR5EK	90426		
115	115 HP		2005->		E-TECH	0,8	IZFR5J	5899		
120	120 HP		1985->1987			1	B9HS-10	3626	BR9HS-10	4551
125	125 HP		1990->		COMMERCIAL	1	B9HS-10	3626	BR9HS-10	4551
140	140 HP		1973->1984			0	BUHXW-1	5526		
140	140 HP		1977->1979		140S	0	BUHXW-1	5526		
140	140 HP		1985->1992			1	BR9HS-10	4551		
150	150 HP		1978->1987			0	BUHXW-1	5526		
150	150 HP		1988->1992			1	B9HS-10	3626	BR9HS-10	4551
155	155 HP		1978->1986		COMMERCIAL	0	BUHXW-1	5526		
155	155 HP		1987->		COMMERCIAL	0	BUHW-2	5626		
155	155 HP		1989->1992		COMMERCIAL	0	BUZ8H	7447		
175	175 HP		1977->1987			0	BUHXW-1	5526		
175	175 HP		1988->1992			1	B9HS-10	3626	BR9HS-10	4551
175	175 HP		2005->			0,8	IZFR5J	5899		
185	185 HP		1984->1985		COMMERCIAL	0	BUHXW-1	5526		
185	185 HP		1990->1992		COMMERCIAL	1	BR9HS-10	4551		
200	200 HP		1976->1983			0	BUHXW-1	5526		
200	200 HP		1986->1992			1	B9HS-10	3626	BR9HS-10	4551
200	200 HP		2005->		F MODEL	0,8	PZFR6H	7696		
200	200 HP		2005->		F MODEL	0,8	PZFR6H	7696		
200	200 HP		2005->		F MODEL	0,8	PZFR6H	7696		
225	225 HP		1986->			1	B9HS-10	3626	BR9HS-10	4551
225	225 HP		2005->		F MODEL	0,8	PZFR6H	7696		
235	235 HP		1978->1985			0	BUHXW-1	5526		
250	250 HP		1991->1992			1	BR9HS-10	4551		
250	250 HP		2005->		F MODEL	0,8	PZFR6H	7696		
275	275 HP		1985->1988			1	BR9HS-10	4551		
300	300 HP		1986->1992			1	B9HS-10	3626	BR9HS-10	4551

HONDA										
8.0	8 HP		2001->		BFP8D1	0,9	CR5EH-9	6689		
9.9	9.9 HP		2001->		BFP9.9D1	0,9	CR5EH-9	6689		
20	20 HP		2003->		BR20D	0,9	CR5EH-9	6689		
20	20 HP				BF20	0,6	BMR4A	5728		
25	25 HP		2004->		BF25D4	0,7	DR7EA	7839		
30	30 HP		2004->		BF30D4	0,7	DR7EA	7839		
30	30 HP				BF30	0,7	D8EA	2120	DR8EA	7162
30	30 HP				GB30	0,6	B6HS	4510	BR6HS	3922
40	40 HP		2008->		BF40D	0,8	DR7EB	5469		
40	40 HP				GB40	0,6	B6HS	4510	BR6HS	3922
45	45 HP				B45	0,6	D6HS	6812		
50	50 HP		2008->		BF50D	0,8	DR7EB	5469		
50	50 HP				BF50	0,7	DR7EA	7839		
60	60 HP		2009->		BF60	0,9	LMAR6C-9	1679		
60	60 HP		2009->		BF60A	0,9	LMAR6C-9	1679		
60	60 HP		2009->		BFP60A	0,9	LMAR6C-9	1679		
75	75 HP		2003->		BF75	0,7	DR7EA	7839		
75	75 HP		2006->		BF75D	1,1	IZFR6K-11E	6748		
75	75 HP				B75K	0,6	D6HS	6812		
75	75 HP				BF75A	0,7	DR7EA	7839		
75	75 HP				BF75E	0,6	D6HS	6812		
100	100 HP				BF100A	0,6	D6HS	6812		
115	115 HP				BF115	0,8	ZFR7F	5913		
125	125 HP	125	2002->2006	1		0,9	IMR9D-9H	6544	CR9EH-9	7502
150	150 HP		2013->		BF150A	1,1	IZFR6K-11	6994	ZFR6K-11	6711
200	200 HP		2002->2012		BF200A	1,1	IZFR6F-11	4095	ZFR6F-11	93208
200	200 HP		2013->		BF200A	1,1	IZFR6K-11E	6748		
225	225 HP		2002->2012		BF225A	1,1	IZFR6F-11	4095	ZFR6F-11	93208
225	225 HP		2013->		BF200A	1,1	IZFR6K-11E	6748		
250	250 HP		2013->		BF250A	1,1	ZFR6K-11E	94001		



MARINE • OUTBOARD



Model	Type	Capacity	Year	Cyl	Engine	Gap	Recommended	Stock Code	Alternative	Stock Code
JOHNSON										
1.5	1.5 HP		1986->1987			0,7	B6S	3510		JOHNSON
1.6	1.6 HP				L115-SD	1	B9HS-10	3626	BR9HS-10	4551
1.8	1.8 HP				L140-SD	1	B9HS-10	3626	BR9HS-10	4551
2	2 HP		1971->1979		2R	0,7	B6S	3510		
2	2 HP		1980->1985			0,7	B6S	3510		
2.5	2.5 HP		1986->			1	B9HS-10	3626	BR9HS-10	4551
2.6	2.6 HP				L290-SD	1	B9HS-10	3626	BR9HS-10	4551
2.7	2.7 HP				L225-SD	1	B9HS-10	3626	BR9HS-10	4551
3.5	3.5 HP		2001->2002			0,7	BPR6HS	7022		
3.6	3.6 HP				L275-SD	1	B9HS-10	3626	BR9HS-10	4551
4	4 HP		1977->1980		R,RW	1	B9HS-10	3626	BR9HS-10	4551
4	4 HP		1985->1987			0,6	B6HS	4510	BR6HS	3922
4	4 HP		1986->1987		DEL	1	B9HS-10	3626	BR9HS-10	4551
4.5	4.5 HP		1979->1980			1	B9HS-10	3626	BR9HS-10	4551
6	6 HP		1977->1979			0	BUHW-2	5626		
6	6 HP		1984->1987			1	B9HS-10	3626	BR9HS-10	4551
7.5	7.5 HP		1980->1983			1	B9HS-10	3626	BR9HS-10	4551
8	8 HP		1984->1986			1	B9HS-10	3626	BR9HS-10	4551
8.0	8 HP		2002->			0,7	DR5HS	4623		
9.9	9.9 HP		1977->1979		E,R,SEL	0	BUHW-2	5626		
9.9	9.9 HP		1980->1986			1	B9HS-10	3626	BR9HS-10	4551
10	10 HP		1981->1982		COMMERCIAL	0	BUHW-2	5626		
10	10 HP		2006->2006			0,8	BR7HS	4122		
14	14 HP		1981->1982		COMMERCIAL	0	BUHW-2	5626		
15	15 HP		1977->1979		E,R	0	BUHW-2	5626		
15	15 HP		1980->1987			1	B9HS-10	3626	BR9HS-10	4551
15	15 HP		2005->			0,8	BK6E	92403	BKR6E	97737
15	15 HP		2006->			0,8	BR7HS	4122		
20	20 HP		1986->1987			1	B9HS-10	3626	BR9HS-10	4551
25	25 HP		1977->1979		E,R	0	BUHW-2	5626		
25	25 HP		1980->1986			1	B9HS-10	3626	BR9HS-10	4551
25	25 HP		1985->1986		COMMERCIAL	1	B9HS-10	3626	BR9HS-10	4551
28	28 HP		1985->1987			1	B9HS-10	3626	BR9HS-10	4551
30	30 HP		1984->1987			1	B9HS-10	3626	BR9HS-10	4551
35	35 HP		1977->1979		E,R	0	BUHW-2	5626		
35	35 HP		1980->1987			1	B9HS-10	3626	BR9HS-10	4551
40	40 HP	815	2002->			0,7	DCPR7E	3932		
40	40 HP		1981->		COMMERCIAL	1	B9HS-10	3626	BR9HS-10	4551
40	40 HP		1982->		COMMERCIAL	0,7	B7HS	5110	BR7HS	4122
40	40 HP		1984->1986		COMMERCIAL	0	BUHW-2	5626		
40	40 HP		1985->1987		40 E	1	B9HS-10	3626	BR9HS-10	4551
40	40 HP		2005->			0,7	DCPR6E	3481		
45	45 HP		1987->		COMMERCIAL	0	BUHW-2	5626		
50	50 HP	815	2002->			0,7	DCPR7E	3932		
50	50 HP		1971->1980			0	BUHW-2	5626		
50	50 HP		1977->1979		R	1	B9HS-10	3626	BR9HS-10	4551
50	50 HP		1981->1987			1	B9HS-10	3626	BR9HS-10	4551
50	50 HP		2005->			0,7	DCPR6E	3481		
55	55 HP		1976->1979		E	0	BUHW	2622		
55	55 HP		1980->1983		COMMERCIAL	0	BUHW	2622		
55	55 HP		1984->1987		COMMERCIAL	1	B9HS-10	3626	BR9HS-10	4551
55	55 HP		1986->2005		COM	0	BUHXW-1	5526		
60	60 HP		1980->1987			1	B9HS-10	3626	BR9HS-10	4551
60	60 HP		2002->2005			0,8	BPR6ES	96989		
65	65 HP		1984->1987		COMMERCIAL HC	1	B9HS-10	3626	BR9HS-10	4551
65	65 HP		1986->		COMMERCIAL LC	0	BUHXW-1	5526		
70	70 HP		1976->1979		EL	1	B9HS-10	3626	BR9HS-10	4551
70	70 HP		1980->1986			1	B9HS-10	3626	BR9HS-10	4551
70	70 HP		2002->2005			0,8	BPR6ES	96989		
75	75 HP		1976->1979		ER	1	B9HS-10	3626	BR9HS-10	4551
75	75 HP		1980->1987			1	B9HS-10	3626	BR9HS-10	4551
85	85 HP		1977->1978		ML,ETLR,TXLR	1	B9HS-10	3626	BR9HS-10	4551
85	85 HP		1979->1980		ML,TL,TX	1	B9HS-10	3626	BR9HS-10	4551
90	90 HP		1981->1987			1	B9HS-10	3626	BR9HS-10	4551
90	90 HP		2003->			0,8	BKR6E	97737		
90	90 HP		2006->			1	BPZ8HS-10	3133		
100	100 HP		1979->		ML,TLR,TXLR	1	B9HS-10	3626	BR9HS-10	4551
100	100 HP		1980->		COMMERCIAL	1	B9HS-10	3626	BR9HS-10	4551
100	100 HP		1984->1987		COMMERCIAL	0	BUHW-2	5626		
110	110 HP		1986->1987			1	B9HS-10	3626	BR9HS-10	4551
115	115 HP		1974->1978		115ETL	1	B9HS-10	3626	BR9HS-10	4551
115	115 HP		1977->1979		115TXL	1	B9HS-10	3626	BR9HS-10	4551



MARINE • OUTBOARD



Model	Type	Capacity	Year	Cyl	Engine	Gap	Recommended	Stock Code	Alternative	Stock Code
JOHNSON										
115	115 HP		1978->1979		115ML	1	B9HS-10	3626	BR9HS-10	4551
115	115 HP		1979->		115TL	1	B9HS-10	3626	BR9HS-10	4551
115	115 HP		1980->1985			1	B9HS-10	3626	BR9HS-10	4551
115	115HP		2006->			1	BPZ8HS-10	3133		
120	120 HP		1985->1987			1	B9HS-10	3626	BR9HS-10	4551
140	140 HP		1977->1979		ML,TL,TXL	0	BUHXW-1	5526		
140	140 HP		1980->1984			0	BUHXW-1	5526		
140	140 HP		1985->1987			1	B9HS-10	3626	BR9HS-10	4551
140	140 HP		2003->2005			0,8	BKR6E	97737		
150	150 HP		1978->1979		TL,TXL	0	BUHXW-1	5526		
150	150 HP		1980->1986			0	BUHXW-1	5526		
150	150 HP		1987->			0	BUHW-2	5626		
150	150 HP		2003->2006			1	BPZ8HS-10	3133		
155	155 HP		1984->1986		COMMERCIAL	0	BUHXW-1	5526		
175	175 HP		1977->1980		TL,TXL	0	BUHXW-1	5526		
175	175 HP		1977->1986			0	BUHXW-1	5526		
175	175 HP		1987->			1	B9HS-10	3626	BR9HS-10	4551
185	185 HP		1984->1986		COMMERCIAL	0	BUHXW-1	5526		
200	20 HP		1976->1980		TL,TXL	0	BUHXW-1	5526		
200	200 HP		1981->1986			0	BUHXW-1	5526		
200	200 HP		1987->			1	B9HS-10	3626	BR9HS-10	4551
225	225 HP		1986->			0	BUHXW-1	5526		
225	225 HP		1987->			1	B9HS-10	3626	BR9HS-10	4551
235	235 HP		1978->1980		TL,TXL	0	BUHXW-1	5526		
235	235 HP		1978->1985			0	BUHXW-1	5526		
235	235 HP		1981->1984			0	BUHXW-1	5526		
250	250 HP		1993->1991			1	BPZ8HS-10	3133		
250	250 HP				LV6	0	BUZ8H	7447		
275	275 HP		1985->1987			1	B9HS-10	3626	BR9HS-10	4551
300	300 HP		1983->1986			1	BPZ8HS-10	3133		
300	300 HP		1994->1995			0,7	BPR6HS	7022		

KONIG										
4	4 HP					0,6	B6HS	4510	BR6HS	3922
5	5 HP				14MM HEADS	0,5	B5HS	4210		
5	5 HP				18MM HEADS	0,6	AB-6	2910		
6	6 HP					0,6	AB-6	2910		
9	9 HP				14 MM HEADS	0,5	B5HS	4210		
9	9 HP				18MM HEADS	0,6	AB-6	2910		
10	10 HP					0,7	B7HS	5110	BR7HS	4122
14	14 HP					0,5	B5HS	4210		
15	15 HP				14MM HEADS	0,6	B6HS	4510	BR6HS	3922
15	15 HP				18MM HEADS	0,6	AB-6	2910		
18	18 HP				14MM HEADS	0,6	B6HS	4510	BR6HS	3922
18	18 HP				18MM HEADS	0,6	AB-6	2910		
25	25 HP					0,6	B6HS	4510	BR6HS	3922
30	30 HP		1979->			0,6	B6HS	4510	BR6HS	3922
30	30 HP		1979->			0,7	B7HS	5110	BR7HS	4122
32	32 HP					0,6	B6HS	4510	BR6HS	3922
40	40 HP					0,6	B6HS	4510	BR6HS	3922
60	60 HP					0,7	B7HS	5110	BR7HS	4122
65	65 HP					0,7	BP7HS	5111		
70	70 HP					0,7	B7HS	5110	BR7HS	4122

MARINER										
2	2 HP				2A646	0,5	B5HS	4210		
2	2 HP				2B6A1	0,5	B5HS	4210		
2.5	2.5 HP		1990->			0,6	BP6HS	4511	BPR6HS	7022
2.5	2.5 HP		1990->2002			1	BPR6HS-10	2633		
3.3	3.3 HP		1993->			0,7	BPR6HS	7022		
3.5	3.5 HP				642	0,7	B7HS	5110	BR7HS	4122
3.5	3.5 HP					0,7	B7HS	5110	BR7HS	4122
4	4 HP		1990->			1	BP7HS-10	7829	BPR7HS-10	1092
4	4 HP				4A6E0	0,7	B7HS	5110	BR7HS	4122
4.0	4.0 HP		1990->2002			1	BPR7HS-10	1092		
4.0	4.0 HP		1990->2002			0,7	DCPR6E	3481		
4.0	4.0 HP				4A6E0	0,7	B7HS	5110	BR7HS	4122
4.4	4.4 HP					1	BPR7HS-10	1092		
5	5 HP		1990->			1	BP7HS-10	7829	BPR7HS-10	1092
5	5 HP		1990->2002			1	BPR7HS-10	1092		



MARINE • OUTBOARD



Model	Type	Capacity	Year	Cyl	Engine	Gap	Recommended	Stock Code	Alternative	Stock Code
MARINER										
5	5 HP		1999->2002			0,7	DCPR6E	3481		
5	5 HP				5B661	0,7	B7HS	5110	BR7HS	4122
5	5 HP				5C6E3	0,7	B7HS	5110	BR7HS	4122
6	6 HP		1992->2002			1	BP8H-N-10	4838		
6	6 HP		2000->2002			0,7	DCPR6E	3481		
8	8 HP		1993->2002			1	BP8H-N-10	4838		
8	8 HP				8A655/647	0,6	B6HS	4510	BR6HS	3922
8	8 HP				8B677	0,7	B7HS	5110	BR7HS	4122
8	8 HP				8C6G1	1	B7HS-10	2129	BR7HS-10	1098
9	9 HP		1999->2002		4 STROKE	0,9	DPR6EA-9	5531		
9.9	9.9 HP				C682	0,7	B7HS	5110	BR7HS	4122
9.9	9.9 HP					1	B7HS-10	2129	BR7HS-10	1098
10	10 HP		1991->			1,5	BP8HS-15	6729		
15	15 HP		1997->2002		MARATHON	1,5	BP8HS-15	6729		
15	15 HP		1998->2002			0,9	DPR6EA-9	5531		
15	15 HP				A,C684/651	0,7	B7HS	5110	BR7HS	4122
15	15 HP				C684-CDI	1	B7HS-10	2129	BR7HS-10	1098
15	15 HP				W662	0,7	B7HS	5110	BR7HS	4122
20	20 HP		1985->2002			1	BP8H-N-10	4838		
20	20 HP				A653	0,6	B6HS	4510	BR6HS	3922
20	20 HP				C6A9	0,7	B7HS	5110	BR7HS	4122
25	25 HP		1993->2002		MARATHON	1	BP8H-N-10	4838		
25	25 HP		1998->2002			0,9	DPR6EA-9	5531		
25	25 HP				C,A695/648	0,7	B7HS	5110	BR7HS	4122
25	25 HP				W6A4	0,7	B7HS	5110	BR7HS	4122
28	28 HP					0,7	B7HS	5110	BR7HS	4122
30	30 HP		1995->2002		MARATHON	1	BP8H-N-10	4838		
30	30 HP		1999->2002			0,9	DPR6EA-9	5531		
30	30 HP		2000->			0,7	DCPR6E	3481		
30	30 HP				MARATHON,A,W	0,7	B7HS	5110	BR7HS	4122
40	40 HP	747	2002->			0,7	DCPR7E	3932		
40	40 HP	995	2000->			0,7	DCPR6E	3481		
40	40 HP	995	2002->			0,7	DCPR7E	3932		
40	40 HP		1995->2002	2	MARATHON	1	BP8H-N-10	4838		
40	40 HP				A676A	0,8	B8HS	5510	BR8HS	4322
40	40 HP				C6E9	0,8	B8HS	5510	BR8HS	4322
40	40 HP				W67A,B	0,8	B8HS	5510	BR8HS	4322
45	45 HP					0	BUHW-2	5626		
48	48 HP				W670	0,7	B7HS	5110	BR7HS	4122
50	50 HP		1990->			0	BUHW-2	5626		
50	50 HP		1992->			0	BUZ8H	7447		
50	50 HP		1995->2001			0,9	DPR6EA-9	5531		
50	50 HP		2000->			0,7	DCPR6E	3481		
50	50 HP					0	BUHW	2622		
50	50 HP					0	BUHW-2	5626		
55	55 HP				W556A3	0,8	B8HS	5510	BR8HS	4322
55	55 HP					1	B8HS-10	5126	BR8HS-10	1134
60	60 HP		1984->1990			0	BUZHW	2147		
60	60 HP		1990->			0	BUHW-2	5626		
60	60 HP		1992->			0	BUZ8H	7447		
60	60 HP		2001->			0,9	DPR6EA-9	5531		
60	60 HP		2002->		EFI	0,7	DCPR7E	3932		
60	60 HP			3		0	BUHW	2622		
60	60 HP					1	B8HS-10	5126	BR8HS-10	1134
60	60 HP					1	BPZ8H-N-10	4495		
70	70 HP					0	BUHW	2622		
75	75 HP		1991->2002		MARATHON	0	BUHW-2	5626		
75	75 HP		2000->			1,1	LFR5A-11	95304		
80	80 HP		1995->2001			1	BP8H-N-10	4838		
80	80 HP					0	BUHW-2	5626		
85	85 HP					0	BUHW-2	5626		
90	90 HP		2000->			1,1	LFR5A-11	95304		
90	90 HP					0	BUHW	2622		
90	90 HP					0	BUHW-2	5626		
100	100 HP				1988	0	BUHW	2622		
115	115 HP		1989->2002			1	BP8H-N-10	4838		
115	115 HP		2000->2002		OPTIMAX	1,1	PZFR5F-11	4363	ZFR5F-11	93814
115	115 HP					0	BUHW	2622		
125	125 HP					1	BPZ8H-N-10	4495		
135	135 HP		1998->2002		OPTIMAX	1,1	PZFR5F-11	4363	ZFR5F-11	93814
135	135 HP				MARATHON	0	BU8H	6431		
140	140 HP					0	BUHW	2622		



MARINE • OUTBOARD



Model	Type	Capacity	Year	Cyl	Engine	Gap	Recommended	Stock Code	Alternative	Stock Code
MARINER										
140	140 HP					0	BUZHW	2147		
150	150 HP		1997->2002		OPTIMAX	1,1	PZFR5F-11	4363	ZFR5F-11	93814
150	150 HP		2000->		MAGNUM	1	BPR7HS-10	1092		
150	150 HP		2000->		V6 EFI	1	BPZ8HS-10	3133		
150	150 HP				A905890	0	BUHW	2622		
150	150 HP				A905891	0	BU8H	6431		
175	175 HP		2000->		EFI	1	BPZ8HS-10	3133		
175	175 HP		2000->		MAGNUM	1	BPR7HS-10	1092		
175	175 HP				A918688	0	BUHW	2622		
175	175 HP				A98686	0	BU8H	6431		
200	200 HP		1997->1999			0	BU8H	6431		
200	200 HP		1997->2002		OPTIMAX	1,1	PZFR5F-11	4363	ZFR5F-11	93814
200	200 HP		2000->			1	BPR7HS-10	1092		
200	200 HP				A914498	0	BU8H	6431		
200	200 HP				A94497	0	BUHW	2622		
220	220 HP					0	BU8H	6431		
225	225 HP		1998->2002		OPTIMAX	1,1	PZFR5F-11	4363	ZFR5F-11	93814
225	225 HP				OPTIMAX	1	BPZ8H-N-10	4495		
225	225 HP					0	BU8H	6431		
250	250 HP		1996->2001		MAGNUM	0,8	BR8HS	4322		
250	250 HP					0	BU8H	6431		
275	275 HP		1991->1994			0	BU8H	6431		
MERCURY										
2.2	2.2 HP		1984->1989			0,6	BP6HS	4511	BPR6HS	7022
2.2	2.2 HP					1	BPR6HS-10	2633		
2.5	2.5 HP				4 STROKE	0,8	DCPR6E	3481		
2.5	2.5 HP					0,7	BPR6HS	7022		
3	3.0 HP					1	BPR6HS-10	2633		
3.4	3.4 HP		1984->1986			0	BUHW	2622		
3.4	3.4 HP		1987->1988			0	BU8H	6431		
3.5	3.5 HP		1983->1985			0,7	BP7HS	5111		
3.5	3.5 HP				4 STROKE	0,8	DCPR6E	3481		
3.6	3.6 HP		1980->1981			0,7	BP7HS	5111		
3.6	3.6 HP		1982->			0,7	BP7HS	5111		
3.9	4 HP		1967->1968			0,5	B5HS	4210		
4	4 HP		1976->1979			0,6	B6HS	4510	BR6HS	3922
4	4 HP		1980->1989			0,7	BP7HS	5111		
4	4 HP		1986->1987			0	BUHW-2	5626		
4	4 HP		2007->		L4SC 4 STROKE	0,8	ILFR6G-E	4212		
4.0	4.0 HP				4 STROKE	0,8	DCPR6E	3481		
4.5	4.5 HP		1975->1985			0	BUHW-2	5626		
5	5 HP		1988->1989			1	BP7HS-10	7829	BPR7HS-10	1092
5.0	5.0 HP				4 STROKE	0,8	DCPR6E	3481		
6	6 HP		1986->			1	BP7HS-10	7829	BPR7HS-10	1092
6	6 HP		1987->1989			1	BP8HS-10	3823		
6	6 HP		1993->1994			1	BPZ8H-N-10	4495		
6	6 HP		2001->2006			1	BPZ8H-N-10	4495		
6.0	6.0 HP				4 STROKE	0,8	DCPR6E	3481		
7.5	7.5 HP		1975->1978			0	BUHW-2	5626		
7.5	7.5 HP		1979->1985			1	B9HS-10	3626	BR9HS-10	4551
8	8 HP		1986->			1	BP7HS-10	7829	BPR7HS-10	1092
8	8 HP		1987->1989			1	BP8HS-10	3823		
8	8 HP		1993->1994			1	BPZ8H-N-10	4495		
8	8 HP		2001->2006			1	BPZ8H-N-10	4495		
8	8 HP		2006->2006			0,7	DCPR6E	3481		
8.0	8.0 HP				4 STROKE	0,8	DCPR6E	3481		
9.8	9.8 HP		1975->1978			0	BUHW-2	5626		
9.8	9.8 HP		1979->1985			1	B9HS-10	3626	BR9HS-10	4551
9.9	9.9 HP		1986->			1	BP7HS-10	7829	BPR7HS-10	1092
9.9	9.9 HP		1987->1989			1	BP8HS-10	3823		
9.9	9.9 HP		1993->1994			1	BPZ8H-N-10	4495		
9.9	9.9 HP		2001->2006			1	BPZ8HS-10	3133		
9.9	9.9 HP		2006->			0,7	DCPR6E	3481		
9.9	9.9 HP				4 STROKE	0,8	DCPR6E	3481		
10	10 HP				SEAPRO	1,5	BP8HS-15	6729		
15	15 HP		2001->2006			1	BPZ8HS-10	3133		
15	15 HP				4 STROKE	0,8	DCPR6E	3481		
15	15 HP					1	BP8HS-10	3823		
18	18 HP		1980->1983			1	B9HS-10	3626	BR9HS-10	4551
18	18 HP		1984->1985		X	0	BUHW	2622		

MARINE



MARINE • OUTBOARD



Model	Type	Capacity	Year	Cyl	Engine	Gap	Recommended	Stock Code	Alternative	Stock Code
MERCURY										
20	20 HP		1970->1980			0	BUHW-2	5626		MERCURY
20	20 HP		1986->1989			0	BUHW	2622		
20	20 HP		1992->1994			1	BPZ8H-N-10	4495		
20	20 HP		2001->2006			1	BPZ8H-N-10	4495		
20	20 HP				4 STROKE	0,8	DCPR6E	3481		
25	25 HP		1980->1983			1	B8HS-10	5126	BR8HS-10	1134
25	25 HP		1984->1989		25XD	0	BUHW	2622		
25	25 HP		1993->1994		SEAPRO	1	BPZ8H-N-10	4495		
25	25 HP		2001->2006			1	BPZ8H-N-10	4495		
25	25 HP		2006->			0,7	DCPR6E	3481		
25	25 HP				4 STROKE	0,8	DCPR6E	3481		
30	30 HP		2006->			0,7	DCPR7E	3932		
30	30 HP				4 STROKE	0,8	DCPR6E	3481		
30	30 HP					1	BPZ8H-N-10	4495		
35	35 HP		1984->1989			0	BUHW	2622		
40	40 HP		1979->1983			0	BUHW	2622		
40	40 HP		2001->2006		BIG FOOT	0,9	DPR6EA-9	5531		
40	40 HP		2001->2006		SEAPRO	1	BPZ8H-N-10	4495		
40	40 HP		2006->			0,7	DCPR7E	3932		
40	40 HP				4 STROKE	0,8	DCPR7E	3932		
45	45 HP		1986->1989			0	BUHW-2	5626		
45	45 HP				4 STROKE	0,9	DPR6EA-9	5531		
50	50 HP		1976->1985			0	BUHW-2	5626		
50	50 HP		1986->1988			0	BUHW	2622		
50	50 HP		1993->1994			1	BPZ8H-N-10	4495		
50	50 HP		2001->2006			1	BPZ8H-N-10	4495		
50	50 HP		2006->			0,7	DCPR7E	3932		
50	50 HP				4 STROKE	0,8	DCPR7E	3932		
55	55 HP		1993->1994		SEAPRO	1	BPZ8H-N-10	4495		
60	60 HP	60	2008->	1		0,8	LFR4A-E	6499		
60	60 HP		1984->1989			0	BUHW	2622		
60	60 HP		2001->2006			1	BPZ8H-N-10	4495		
60	60 HP		2006->			0,7	DCPR7E	3932		
60	60 HP				4 STROKE	0,8	DCPR7E	3932		
70	70 HP		1979->1983			0	BUHW	2622		
70	70 HP		1987->1989			0	BUHW-2	5626		
75	75 HP	1596			4 STROKE	1,1	LFR5A-11	95304		
75	75 HP		1984->1986			0	BUHW-2	5626		
75	75 HP		2000->2006			1,1	LFR5A-11	95304		
75	75 HP		2001->2006			0	BUZHW-2	2173		
75	75 HP		2006->		OPTIMAX	0,8	IZFR5J	5899		
75	75 HP				4 STROKE	0,8	LFR4A-E	6499		
80	80 HP		78-83, 86-89			0	BUHW-2	5626		
80	80 HP				4 STROKE	0,8	LFR4A-E	6499		
85	85 HP		1977->			0	BUHW-2	5626		
90	90 HP		1978->1986			0	BUHW	2622		
90	90 HP		1987->1989			0	BUHW-2	5626		
90	90 HP		2000->2006			1,1	LFR5A-11	95304		
90	90 HP		2006->		OPTI MAX	0,8	IZFR5J	5899		
90	90 HP				4 STROKE	0,8	LFR4A-E	6499		
100	100 HP		1988->1989			0	BUHW	2622		
100	100 HP		1991->1994			1	BPZ8H-N-10	4495		
100	100 HP				4 STROKE	0,8	LFR4A-E	6499		
115	115 HP	1741			4 STROKE	1,1	LFR6A-11	3672		
115	115 HP		1970->1988			0	BUHW	2622		
115	115 HP		1991->1994	4		1	BPZ8H-N-10	4495		
115	115 HP		2001->2006		MFI4	1,1	LFR5A-11	95304		
115	115 HP		2001->2006			1	BPZ8H-N-10	4495		
115	115 HP		2006->		OPTIMAX	0,8	IZFR5J	5899		
115	115 HP				4 STROKE	0,8	LFR4A-E	6499		
125	125 HP		1994			1	BPZ8H-N-10	4495		
125	125 HP		2001->2006			1	BPZ8H-N-10	4495		
135	135 HP		1969->1989		V-135	0	BU8H	6431		
135	135 HP		2003->2006		DFI6	0,8	IZFR5G	5887		
135	135 HP		2006->		135 EFI 4 STROKE	0,8	ILFR6G-E	4212		
135	135 HP		2006->		4 STROKE	0,8	ILFR6G-E	4212		
135	135 HP VERADO				4 STROKE	0,8	ILFR6G-E	4212		
140	140 HP		1978->1980			0	BUHW	2622		
150	150 HP		1973->1984			0	BUHW	2622		
150	150 HP		1985->1989		XR-4,V-150	0	BU8H	6431		
150	150 HP		2000->2006		EFI6	1	BPZ8HS-10	3133		
150	150 HP		2000->2006			1	BPZ8HS-10	3133		



MARINE • OUTBOARD



Model	Type	Capacity	Year	Cyl	Engine	Gap	Recommended	Stock Code	Alternative	Stock Code
MERCURY										
150	150 HP		2006->		EFI6 4 STROKE	0,8	ILFR6G-E	4212		
150	150 HP				4 STROKE	0,8	ZFR5F-11	93814		
150	150 HP				OPTIMAX	1,1	PZFR5F-11	4363	ZFR5F-11	93814
150	150 HP VERADO				4 STROKE	0,8	ILFR6G-E	4212		
175	175 HP		1976->1981			0	BUHW	2622		
175	175 HP		1986->1989		V-175	0	BU8H	6431		
175	175 HP		2003->2006		OPTIMAX	0,8	IZFR5G	5887		
175	175 HP		2006->		175 EFI 4 STROKE	0,8	ILFR6G	5588	LF66B	6677
175	175 HP		2006->		EFI6 4 STROKE	0,8	ILFR6G	5588	LF66B	6677
175	175 HP VERADO				4 STROKE	0,8	ILFR6G-E	4212		
200	200 HP		1978->1985			0	BUHW	2622		
200	200 HP		1986->1989		V-200	0	BU8H	6431		
200	200 HP		2000->			1	BPZ8HS-10	3133		
200	200 HP		2000->2006		MF16	1	BPZ8HS-10	3133		
200	200 HP		2006->		EFI6	0,8	BR8HS	4322		
200	200 HP		2006->		EFI6 4 STROKE	0,8	ILFR6G	5588	LF66B	6677
200	200 HP				4 STROKE	0,8	ILFR6G	5588	LF66B	6677
200	200 HP				OPTIMAX	1,1	PZFR5F-11	4363	ZFR5F-11	93814
200	200 HP		2003->2006		OPTIMAX	0,8	IZFR5G	5887		
200	200 HP VERADO				4 STROKE	0,8	ILFR6G-E	4212		
220	220 HP		1987->1988		V-220	0	BU8H	6431		
225	225 HP		1980->1981			0	BUHW	2622		
225	225 HP		1994			1	BPZ8H-N-10	4495		
225	225 HP		1994->1997			1	BPZ8H-N-10	4495		
225	225 HP		1995->2006			0,8	BR8HS	4322		
225	225 HP		2006->		OPTIMAX	0,8	IZFR5G	5887		
225	225 HP		2006->			1,1	LF66A-11	95304		
225	225 HP				4 STROKE	1,1	LF66A-11	95304		
225	225 HP VERADO				4 STROKE	0,8	ILFR6G-E	4212		
250	250 HP		2003->2006		OPTIMAX	0,7	IZFR6J	4462		
250	250 HP		2006->		4 STROKE	0,8	ILFR6G-E	4212		
250	250 HP					0	BU8H	6431		
250	250 HP VERADO				4 STROKE	0,8	ILFR6G-E	4212		
275	275 HP		2006->		4 STROKE	0,8	ILFR6G-E	4212		
275	275 HP VERADO				4 STROKE	0,8	ILFR6G-E	4212		
300	300 HP		1980->1983			0	BUHW	2622		
300	300 HP		2007->		OPTIMAX 300XS	0,8	IZFR7M	4214		
300	300 HP VERADO				4 STROKE	0,8	ILFR6G-E	4212		
350	350 HP VERADO				4 STROKE	0,8	ILFR6G-E	4212		

NISSAN										
3.5	3.5 HP		1997->2006		NS3.5A	1	BPR6HS-10	2633		
3.5	3.5 HP				NS 3.5A	0,6	BP6HS	4511	BPR6HS	7022
4	4 HP		2000->2006		NSF4A	0,7	DCPR6E	3481		
5	5 HP		1997->2006		NS5B	1	BPR7HS-10	1092		
5	5 HP		1999->2006		NSF5A	0,7	DCPR6E	3481		
5	5 HP				NS5B	0,7	BP7HS	5111		
8	8 HP		1997->2006		NS8B	1	BPR7HS-10	1092		
8	8 HP		2004->2006		NSF8A	0,7	DCPR6E	3481		
9	9 HP				Y9	0,6	B6HS	4510	BR6HS	3922
9.9	9.9 HP		1997->2006		NS9.9B	1	BR7HS-10	1098		
9.9	9.9 HP		2000->2006		NSF9.9A	0,7	DCPR6E	3481		
9.9	9.9 HP				NS 9.9B	1	B7HS-10	2129	BR7HS-10	1098
12	12 HP		2004->2006		NS12C	1	BR7HS-10	1098		
12	12 HP				NS12C C2	1	B7HS-10	2129	BR7HS-10	1098
12	12 HP				Y12	0,7	B7HS	5110	BR7HS	4122
15	15 HP		2004->2006		NS15B	1	BR7HS-10	1098		
15	15 HP		2004->2006		NSF15A	0,7	DCPR6E	3481		
15	15 HP				NS15BB2	1	B7HS-10	2129	BR7HS-10	1098
15	15 HP				Y15	0,7	B7HS	5110	BR7HS	4122
18	18 HP		2004->2006		NS18C	1	B7HS-10	2129	BR7HS-10	1098
18	18 HP		2004->2006		NSF18B	0,7	DCPR6E	3481		
18	18 HP				NS18C C2	1	B7HS-10	2129	BR7HS-10	1098
25	25 HP		1997->2006		NS25C	1	BR7HS-10	1098		
25	25 HP		2004->2006		NSF25A	0,7	DCPR6E	3481		
25	25 HP				NS25C C2	1	B7HS-10	2129	BR7HS-10	1098
30	30 HP		1997->2006		NS30A	1	BR7HS-10	1098		
30	30 HP		2004->2006		NSF30A4	0,7	DCPR6E	3481		
30	30 HP				NS30A2 A3	1	B7HS-10	2129	BR7HS-10	1098
40	40 HP		1997->2006		NS40D	1	BR7HS-10	1098		
40	40 HP		2004->2006		NS40C	1	BR7HS-10	1098		



MARINE • OUTBOARD



Model	Type	Capacity	Year	Cyl	Engine	Gap	Recommended	Stock Code	Alternative	Stock Code
NISSAN										
40	40 HP		2004->2006		NSD40ATLDI	1,1	ZFR6F-11	93208		
40	40 HP		2004->2006		NSD40BTLDI	0,8	PZFR6H	7696		
40	40 HP				NS40C	1	B7HS-10	2129	BR7HS-10	1098
50	50 HP		1997->2006		NS50D	1	BR8HS-10	1134		
50	50 HP		2004->2006		NSD50ATLDI	1,1	ZFR6F-11	93208		
50	50 HP		2004->2006		NSD50BTLDI	0,8	PZFR6H	7696		
50	50 HP		2004->2006		NSD50BTLDI	0,8	PZFR6H	7696		
55	55 HP				NS55B	1	B8HS-10	5126	BR8HS-10	1134
60	60 HP		2004->2006		NS60B	1	B8HS-10	5126	BR8HS-10	1134
70	70 HP		2000->2006		NS70C	1	BR8HS-10	1134		
70	70 HP		2004->2006		NS70B	1	B8HS-10	5126	BR8HS-10	1134
70	70 HP		2004->2006		NSD70ATLDI	1,1	ZFR6F-11	93208		
70	70 HP		2004->2006		NSD70BTLDI	0,8	PZFR6H	7696		
70	70 HP				NS70A A2	1	B8HS-10	5126	BR8HS-10	1134
90	90 HP		1997->2006		NS90A	1	BR8HS-10	1134		
90	90 HP		2004->2006		NSD90ATLDI	1,1	ZFR6F-11	93208		
120	120 HP		1997->2006->		NS120A	1	BR8HS-10	1134		
140	140 HP		1997->2006		NS 140A2	1	BR8HS-10	1134		

OPTIMAX										
2.5	2.5 HP					0,9	DPR6EA-9	5531		
4	4 HP					0,7	DCPR6E	3481		
5	5 HP					0,7	DCPR6E	3481		
8	8 HP					0,7	DCPR6E	3481		
9.9	9.9 HP					0,7	DCPR6E	3481		
50	50 HP					0,9	DPR6EA-9	5531		
60	60 HP				EFI	0,7	DCPR7E	3932		
60	60 HP					0,9	DPR6EA-9	5531		
75	75 HP					1,1	LFR5A-11	95304		
90	90 HP					1,1	LFR5A-11	95304		
115	115 HP				EFI	1,1	LFR6A-11	3672		
135	135 HP					0,8	IZFR5G	5887		
150	150 HP					0,8	IZFR5G	5887		
200	200 HP					0,8	IZFR5G	5887		
225	225 HP					0,8	IZFR5G	5887		
250	250 HP		2001->		250DFI	1,1	PZFR5F-11	4363	ZFR5F-11	93814
250	250 HP		2003->		250DFI	0,8	IZFR5G	5887		

SUZUKI										
2	2 HP				DT2	0,5	B5HS	4210		
2.5	2.5 HP		2006->2009		DF2.5	0,8	CR6HSA	2983		
3.5	3.5 HP				DT3.5	0,6	BP6HS	4511	BPR6HS	7022
4	4 HP		1985->		DT4	0,6	B6HS	4510	BR6HS	3922
4	4 HP		1986->		DT4	0,6	BP6HS	4511	BPR6HS	7022
4	4 HP		2003->2004		DF4	0,8	BPR6ES	96989		
4	4 HP		2011->		DF4	0,9	CPR6EA-9S	1582		
5	5 HP				DT5	0,6	BP6HS	4511	BPR6HS	7022
5	5 HP				DT5W	0,6	BP6HS	4511	BPR6HS	7022
6	6 HP		1985->1986		DT6	0,6	B6HS	4510	BR6HS	3922
6	6 HP		1986->		DT6	0,6	BP6HS	4511	BPR6HS	7022
6	6 HP		1993->2002	2	DT6	0,8	BR6HS	3922		
6	6 HP		2003->2004		DF6	0,8	BPR6ES	96989		
6	6 HP		2003->2004		DF6	0,8	BPR6ES	96989		
6	6 HP		2011->		DF6	0,9	CPR6EA-9S	1582		
7	7 HP		1985->		DT7	0,6	B6HS	4510	BR6HS	3922
8	8 HP		2010->		DFAR	0,8	CR6E	6965		
8	8 HP				DT8,C	0,6	BP6HS	4511	BPR6HS	7022
8.0	8.0 HP		2010->		DF8AR	0,8	CR6E	6965		
9.9	9.9 HP		1979->1983		DT9.9	0,6	B6HS	4510	BR6HS	3922
9.9	9.9 HP		1986->		DT9.9C	0,7	B7HS	5110	BR7HS	4122
9.9	9.9 HP		1996->2004	2	DF9.9	0,7	DCPR6E	3481		
9.9	9.9 HP		2011->		DF9.9	0,9	CPR6EA-9S	1582		
15	15 HP		1983->		DT15	1	B7HS-10	2129	BR7HS-10	1098
15	15 HP		1983->		DT15E	1	B7HS-10	2129	BR7HS-10	1098
15	15 HP		1984->		DT15C	0,7	B7HS	5110	BR7HS	4122
15	15 HP		1984->		DT15E	0,7	B7HS	5110	BR7HS	4122
15	15 HP		1986->		DT15K	0,6	B6HS	4510	BR6HS	3922
15	15 HP		1996->2004	2	DF15	0,7	DCPR6E	3481		
15	15 HP		1996->2004		DF152	0,7	DCPR6E	3481		
15	15 HP		2011->		DF15	0,9	CPR6EA-9S	1582		



MARINE • OUTBOARD



Model	Type	Capacity	Year	Cyl	Engine	Gap	Recommended	Stock Code	Alternative	Stock Code
SUZUKI										
16	16 GP				DT16	0,7	B7HS	5110	BR7HS	4122
16	16 HP				DT16P	0,7	B7HS	5110	BR7HS	4122
20	20 HP		1985->		DT20	0,7	B7HS	5110	BR7HS	4122
20	20 HP		1985->		DT20P	0,7	B7HS	5110	BR7HS	4122
20	20 HP		1986->		DT20	1	B7HS-10	2129	BR7HS-10	1098
25	25 HP		1986->		DT25E	1	B7HS-10	2129	BR7HS-10	1098
25	25 HP		2000->2004	3	DF25	0,7	DCPR6E	3481		
25	25 HP		2010->		DF25	0,8	CR6HSA	2983		
25	25 HP				DT25	0,7	B7HS	5110	BR7HS	4122
28	28 HP				DT28	0,7	B7HS	5110	BR7HS	4122
30	30 HP		1983->1985		DT30	1	B7HS-10	2129	BR7HS-10	1098
30	30 HP		1986->		DT30C	1	B7HS-10	2129	BR7HS-10	1098
30	30 HP		2000->2004		DF303	0,7	DCPR6E	3481		
40	40 HP		1999->2004	3	DF40	0,7	DCPR6E	3481		
40	40 HP				DT40,C	0,8	B8HS	5510	BR8HS	4322
46	46 HP		2005->2008		DF46	0,8	BPR6ES	96989		
50	50 HP		1999->2004	3	DF50	0,7	DCPR6E	3481		
50	50 HP				DF50	0,7	DCPR6E	3481		
50	50 HP				DT50	0,8	B8HS	5510	BR8HS	4322
55	55 HP				DT55,C	1	B8HS-10	5126	BR8HS-10	1134
60	60 HP		1998->2004		DF60	0,8	BPR6ES	96989		
60	60 HP				DT60	1	B8HS-10	5126	BR8HS-10	1134
65	65 HP				DT65,C	0,8	B8HS	5510	BR8HS	4322
70	70 HP		1998->2004		DF70	0,8	BPR6ES	96989		
70	70 HP		2005->2007		DF70THL, TL	0,8	BPR6ES	96989		
70	70 HP		2009->2010		DF70A	0,8	DCPR6E	3481		
75	75 HP		1985->		DT75	0,8	B8HS	5510	BR8HS	4322
75	75 HP		1985->		DT75C	0,8	B8HS	5510	BR8HS	4322
75	75 HP		1986->		DT75C	1	B8HS-10	5126	BR8HS-10	1134
80	80 HP		2009->2010		DF80A	0,8	DCPR6E	3481		
85	85 HP				DT85,C	0,8	B8HS	5510	BR8HS	4322
90	90 HP		2001->2004		DF90	0,8	BKR6E	97737		
90	90 HP		2009->2010		DF90A	0,8	DCPR6E	3481		
99	99 HP		2010->		DF99A	0,8	CR6E	6965		
100	100 HP				DT100C	1	BR8HCS-10	1157		
115	115 HP		2001->2005		DF115	0,8	BKR6E	97737		
115	115 HP				DT115,C	0,8	B8HS	5510	BR8HS	4322
140	140 HP		2002->2004		DF140	0,8	BKR6E	97737		
140	140 HP				DT140,C	0,8	B8HS	5510	BR8HS	4322
150	150 HP		1987->2003		DT150	1	BR8HS-10	1134		
150	150 HP				DT150	0,8	B8HS	5510	BR8HS	4322
150	150 HP				DT150C	1	B8HS-10	5126	BR8HS-10	1134
200	200 HP		2004->	6	DF200	0,8	BKR6EIX	6418		
200	200 HP				DT200TC	1	B8HS-10	5126	BR8HS-10	1134
200	200 HP				DT200,C,S	1	B8HS-10	5126	BR8HS-10	1134
225	225 HP		1987->2003		DT225 V6	1	BR8HS-10	1134		
225	225 HP		2004->2004		DF225 V6	0,8	BKR6E	97737		
225	225 HP				DT225 EFI	1	B8HS-10	5126	BR8HS-10	1134
250	250 HP		2004->		DF250 V6	0,8	BKR6E	97737		

TOHATSU										
Model	Type	Capacity	Year	Cyl	Engine	Gap	Recommended	Stock Code	Alternative	Stock Code
2.5	2.5 HP				M2.5A	0,6	BP6HS	4511	BPR6HS	7022
3.5	3.5 HP		1985->		M3.5A	0,7	B7HS	5110	BR7HS	4122
3.5	3.5 HP		1986->		M3.5A	0,6	BP6HS	4511	BPR6HS	7022
5	5 HP				M5A2 S	0,7	B7HS	5110	BR7HS	4122
5	5 HP				M5B S	0,7	BP7HS	5111		
5	5 HP				MFS5	0,8	DCPR6E	3481		
8	8 HP				M8A	0,7	B7HS	5110	BR7HS	4122
9.8	9.8 HP				M9.8A	0,7	B7HS	5110	BR7HS	4122
9.9	9.9 HP				M9.9A	0,7	B7HS	5110	BR7HS	4122
9.9	9.9 HP				M9.9B	1	B7HS-10	2129	BR7HS-10	1098
9.9	9.9 HP					1	BR7HS-10	1098		
12	12 HP				M12A	0,7	B7HS	5110	BR7HS	4122
12	12 HP				M12B	0,7	B7HS	5110	BR7HS	4122
12	12 HP				M12C	1	B7HS-10	2129	BR7HS-10	1098
15	15 HP				M15A	0,7	B7HS	5110	BR7HS	4122
15	15 HP				M15B	1	B7HS-10	2129	BR7HS-10	1098
15	15 HP				MFS15C	0,8	DCPR6E	3481		
16	16 HP				M16A2	0,7	B7HS	5110	BR7HS	4122
18	18 HP		1982->1986		M18C	1	B7HS-10	2129	BR7HS-10	1098
18	18 HP				M18A	0,7	B7HS	5110	BR7HS	4122



MARINE • OUTBOARD



Model	Type	Capacity	Year	Cyl	Engine	Gap	Recommended	Stock Code	Alternative	Stock Code
-------	------	----------	------	-----	--------	-----	-------------	------------	-------------	------------

TOHATSU										
20	20 HP				M20A2	0,7	B7HS	5110	BR7HS	4122
25	25 HP		1984->		M25B	0,7	B7HS	5110	BR7HS	4122
25	25 HP		1984->1986		M25C	1	B7HS-10	2129	BR7HS-10	1098
25	25 HP		1985->		M25B	1	B7HS-10	2129	BR7HS-10	1098
25	25 HP		1986->2006		M25C2	1	B7HS-10	2129	BR7HS-10	1098
25	25 HP		2004->2006		MSF25A	0,7	DCPR6E	3481		
25	25 HP				M25A2	0,7	B7HS	5110	BR7HS	4122
30	30 HP		1984->		M30A2	0,7	B7HS	5110	BR7HS	4122
30	30 HP		1985->		M30A	0,7	B7HS	5110	BR7HS	4122
30	30 HP		1985->		M30A2	1	B7HS-10	2129	BR7HS-10	1098
30	30 HP		1986->		M30A	1	B7HS-10	2129	BR7HS-10	1098
30	30 HP		2004->2006		M30A3	1	B7HS-10	2129	BR7HS-10	1098
30	30 HP		2004->2006		MSF30A	0,7	DCPR6E	3481		
35	35 HP				M35B	0,7	BP7HS	5111		
40	40 HP		1983->2006		M40C	1	B7HS-10	2129	BR7HS-10	1098
40	40 HP		1984->		M40C	0,7	BP7HS	5111		
40	40 HP		1985->		M40C	1	B7HS-10	2129	BR7HS-10	1098
40	40 HP		2004->2006		MD40ATLDI	1,1	ZFR6F-11	93208		
40	40 HP		2004->2006		MD40BTLDI	0,8	PZFR6H	7696		
50	50 HP		2004->2006		M50C	1	B8HS-10	5126	BR8HS-10	1134
50	50 HP		2004->2006		MD50ATLDI	1,1	ZFR6F-11	93208		
50	50 HP		2004->2006		MD50BTLDI	0,8	PZFR6H	7696		
55	55 HP		2004->2006		M55B	1	B8HS-10	5126	BR8HS-10	1134
55	55 HP				M55A	1	B8HS-10	5126	BR8HS-10	1134
55	55 HP				M55B	1	B8HS-10	5126	BR8HS-10	1134
60	60 HP		1992->2006		M60B	1	B8HS-10	5126	BR8HS-10	1134
60	60 HP		2004->2006		M60A	1	B8HS-10	5126	BR8HS-10	1134
70	70 HP		2004->2006		M70A	1	B8HS-10	5126	BR8HS-10	1134
70	70 HP		2004->2006		MD70ATLDI	1,1	ZFR6F-11	93208		
70	70 HP		2004->2006		MD70BTLDI	0,8	PZFR6H	7696		
70	70 HP				M70A	1	B8HS-10	5126	BR8HS-10	1134
90	90 HP		1997->2006		M90A	1	BR8HS-10	1134		
90	90 HP		2004->2006		MD90ATLDI	1,1	ZFR6F-11	93208		
90	90 HP		2004->2006		MD90BTLDI	0,8	PZFR6H	7696		
115	115 HP		2004->2006		M115A	1	B8HS-10	5126	BR8HS-10	1134
120	120 HP		2004->2006		M120A	1	B8HS-10	5126	BR8HS-10	1134
140	140 HP		1997->2006		M140A	1	BR8HS-10	1134		

VOLVO-PENTA										
3.2	3.2 HP					0,7	B7HS	5110	BR7HS	4122
3.3	3.3 HP					0,7	B7HS	5110	BR7HS	4122
3.5	3.5 HP					0,7	B7HS	5110	BR7HS	4122
3.9	3.9 HP					0,7	B7HS	5110	BR7HS	4122
4	4 HP					0,7	B7HS	5110	BR7HS	4122
5	5 HP					0,7	B7HS	5110	BR7HS	4122
5	5 HP					0,7	B7HS	5110	BR7HS	4122
8	8 HP					0,5	B5HS	4210		
9	9 HP					0,5	B5HS	4210		
9.2	9.2 HP					0,7	B7HS	5110	BR7HS	4122
123	123 HP					0,7	B7HS	5110	BR7HS	4122
124	124 HP					0,7	B7HS	5110	BR7HS	4122
140	140 HP					0,5	B5HS	4210		
151	151 HP					0,5	B5HS	4210		
181	181 HP					0,5	B5HS	4210		
200	200 HP					0,8	B8HS	5510	BR8HS	4322
212	212 HP					0,5	B5HS	4210		
250	250 HP					0,7	BP7HS	5111		
252	252 HP					0,7	BP7HS	5111		
280	280 HP					0,8	B8HS	5510	BR8HS	4322
350	350 HP					0,8	B8HS	5510	BR8HS	4322
400	400 HP					0,8	B8HS	5510	BR8HS	4322
450	450 HP					0,8	B8HS	5510	BR8HS	4322
550	550 HP				X	0,8	B8HS	5510	BR8HS	4322
550	550 HP					0,8	B8HS	5510	BR8HS	4322
600	600 HP					0,8	B8HS	5510	BR8HS	4322
700	700 HP					0,8	B8HS	5510	BR8HS	4322

YAMAHA										
2	2 HP		1984->		B	0,5	B7HS	5110	BR7HS	4122
2	2 HP		1984->2002		2CMHS	0,8	B7HS	5110	BR7HS	4122



MARINE • OUTBOARD



Model	Type	Capacity	Year	Cyl	Engine	Gap	Recommended	Stock Code	Alternative	Stock Code
YAMAHA										
2	2 HP		1985->			0,7	B7HS	5110	BR7HS	4122
2	2 HP			A		0,6	B7HS	5110	BR7HS	4122
2.5	2.5 HP		2003->2005			0,7	BR6HS	3922		
2.5	2.5 HP		2006->2010		F2.5MSH	0,8	BR6HS	3922		
3	3 HP		1990->		3AMH	0,7	B6HS	4510	BR6HS	3922
3.0	3.0 HP		1988->2002			0,8	BR6HS	3922		
3.5	3.5 HP			A		0,7	B7HS	5110	BR7HS	4122
3.5	3.5 HP			AC		0,7	B7HS	5110	BR7HS	4122
3.5	3.5 HP			AL		0,7	B7HS	5110	BR7HS	4122
4	4 HP		1999->2005		F8CMHL	0,7	BR7HS	4122		
4	4 HP		1999->2005			0,7	BR6HS	3922		
4	4 HP			A		0,7	B7HS	5110	BR7HS	4122
4	4 HP			ACS		0,7	B7HS	5110	BR7HS	4122
4	4 HP			AS		0,7	B7HS	5110	BR7HS	4122
5	5 HP		1984->		5CMHL	0,7	B7HS	5110	BR7HS	4122
5	5 HP		1985->2002		5CMH	0,8	B7HS	5110	BR7HS	4122
5	5 HP			DPE		1	B7HS-10	2129	BR7HS-10	1098
6	6 HP		2001->2005			0,8	B7HS	5110	BR7HS	4122
6	6 HP		2006->2010		6CMH	1	B7HS-10	2129	BR7HS-10	1098
6	6 HP			A		0,6	B7HS	5110	BR7HS	4122
6	6 HP			B		0,5	B7HS	5110	BR7HS	4122
7	7 HP			A		0,6	B6HS	4510	BR6HS	3922
8	8 HP		1986->2005		E8DMH	1	B7HS-10	2129	BR7HS-10	1098
8	8 HP		2001->2005			1	B7HS-10	2129	BR7HS-10	1098
8	8 HP		2006->2010		8CMH	1	B7HS-10	2129	BR7HS-10	1098
8	8 HP		2006->2010		8CMHL	1	BR7HS-10	1098		
8	8 HP		2006->2010		8CMHS	1	BR7HS-10	1098		
8	8 HP		2006->2010		8MSH	1	B7HS-10	2129	BR7HS-10	1098
8	8 HP		2006->2010		F8C, M	1	B7HS-10	2129	BR7HS-10	1098
8	8 HP			A		0,6	B6HS	4510	BR6HS	3922
8	8 HP			B		0,7	B7HS	5110	BR7HS	4122
8	8 HP			BK		0,8	B7HS	5110	BR7HS	4122
8	8 HP			YEMS V8MTR 350 CUBIC INCH		0,8	BR6FS	4323		
9	9 HP			A		0,6	B6HS	4510	BR6HS	3922
9.5	9.5 HP			A		0,7	B7HS	5110	BR7HS	4122
9.9	9.9 HP		1985->2004		F9.9FMHL	0,7	CR6HSA	2983		
9.9	9.9 HP		1985->2004		F9.9FMHS	0,7	CR6HSA	2983		
9.9	9.9 HP		1985->2004		FT9.9GEL	0,7	CR6HSA	2983		
9.9	9.9 HP		2005->		F9.9	0,9	DPR6EA-9	5531		
9.9	9.9 HP		2006->2010		9.9MSH	1	B7HS-10	2129	BR7HS-10	1098
9.9	9.9 HP		2006->2010		F9.9ELR2	0,9	DPR6EA-9	5531		
9.9	9.9 HP		2006->2010		F9.9ELR,MLH	0,8	CR6HSA	2983		
9.9	9.9 HP		2006->2010		F9.9F	1	BR6HS	3922		
9.9	9.9 HP		2006->2010		F9.9MLH2	0,9	DPR6EA-9	5531		
9.9	9.9 HP		2006->2010		F9.9MSH2	0,9	DPR6EA-9	5531		
9.9	9.9 HP		2006->2010		T9.9ELH2	0,9	DPR6EA-9	5531		
9.9	9.9 HP		2006->2010		T9.9ELH,ELR,EXH	0,8	CR6HSA	2983		
9.9	9.9 HP		2006->2010		T9.9ELR2	0,9	DPR6EA-9	5531		
9.9	9.9 HP		2006->2010		T9.9EXH2	0,9	DPR6EA-9	5531		
9.9	9.9 HP			CPE CE C BE B		0,7	B7HS	5110	BR7HS	4122
9.9	9.9 HP			D		1	B7HS-10	2129	BR7HS-10	1098
9.9	9.9 HP			DPE		1	B7HS-10	2129	BR7HS-10	1098
9.9	9.9 HP			DS		1	B7HS-10	2129	BR7HS-10	1098
9.9	9.9 HP			E9.9DMH		1	B8HS-10	5126	BR8HS-10	1134
9.9	9.9 HP			F9.9BM		0,7	C6HSA	3228	CR6HSA	2983
12	12 HP			A		0,7	B7HS	5110	BR7HS	4122
15	15 HP		1998->		F15CMHL	0,9	DPR6EA-9	5531		
15	15 HP		1998->		F15CMHS	0,9	DPR6EA-9	5531		
15	15 HP		2006->2010		15FMHL	1	BR7HS-10	1098		
15	15 HP		2006->2010		15FMHS	1	BR7HS-10	1098		
15	15 HP		2006->2010		15MSH	1	B7HS-10	2129	BR7HS-10	1098
15	15 HP		2006->2010		E15DMHL	1	BR7HS-10	1098		
15	15 HP		2006->2010		F15C	0,9	DPR6EB-9	3108		
15	15 HP		2006->2010		F15E,M,P	0,9	DPR6EA-9	5531		
15	15 HP			A,B BE C CE CPE		0,7	B7HS	5110	BR7HS	4122
15	15 HP			E15DMH		1	B8HS-10	5126	BR8HS-10	1134
15	15HP		1998->2004		4 STROKE	0,9	DPR6EA-9	5531		
20	20 HP		1999->		F20BMHS	0,9	DPR6EA-9	5531		
20	20 HP		2006->2010		F20	0,9	DPR6EB-9	3108		
20	20 HP			A,B,AE		0,6	B6HS	4510	BR6HS	3922
20	20 HP			BE		0,6	B6HS	4510	BR6HS	3922

MARINE



MARINE • OUTBOARD



Model	Type	Capacity	Year	Cyl	Engine	Gap	Recommended	Stock Code	Alternative	Stock Code
YAMAHA										YAMAHA
20	20 HP				BMK	0,6	B6HS	4510	BR6HS	3922
20	20 HP				C,CE	0,7	B7HS	5110	BR7HS	4122
25	25 HP		1984->2005		E25BMHL	1	BR7HS-10	1098		
25	25 HP		1990->		25N	1	BR7HS-10	1098		
25	25 HP		1998->2005		F25DEL	0,9	DPR6EA-9	5531		
25	25 HP		1998->2005		F25DMHL	0,9	DPR6EA-9	5531		
25	25 HP		1998->2005		F25DMHS	0,9	DPR6EA-9	5531		
25	25 HP		2006->2010		25	1	B7HS-10	2129	BR7HS-10	1098
25	25 HP		2006->2010		25BMHL	1	BR7HS-10	1098		
25	25 HP		2006->2010		25BMHS	1	BR7HS-10	1098		
25	25 HP		2006->2010		F25E,M,T	0,9	DPR6EA-9	5531		
25	25 HP		2006->2010		F25L,S	0,9	DPR6EB-9	3108		
25	25 HP		2006->2010		T25LA	0,9	DPR6EB-9	3108		
25	25 HP		2006->2010		T25TLR	0,9	DPR6EA-9	5531		
25	25 HP				AE A AF B BE C	0,7	B7HS	5110	BR7HS	4122
25	25 HP				CE D DE	0,7	B7HS	5110	BR7HS	4122
25	25 HP				CMK DMS DM	0,7	B7HS	5110	BR7HS	4122
28	28 HP				A	0,7	B7HS	5110	BR7HS	4122
28	28 HP				AE	0,7	B7HS	5110	BR7HS	4122
30	30 HP		1987->2002		30HMHL	1	BR7HS-10	1098		
30	30 HP		1987->2002		30HMHS	1	BR7HS-10	1098		
30	30 HP		1987->2002		30HWL	1	BR7HS-10	1098		
30	30 HP		2001->2005		F30	0,9	DPR6EA-9	5531		
30	30 HP		2006->2010		F30TLR	0,9	DPR6EA-9	5531		
30	30 HP				A	0,7	B7HS	5110	BR7HS	4122
30	30 HP				AE	0,7	B7HS	5110	BR7HS	4122
30	30 HP				AM	0,7	B7HS	5110	BR7HS	4122
30	30 HP				B	0,7	B7HS	5110	BR7HS	4122
30	30 HP				BM	0,7	B7HS	5110	BR7HS	4122
30	30 HP				D	1	B7HS-10	2129	BR7HS-10	1098
30	30 HP				DMS	1	B7HS-10	2129	BR7HS-10	1098
40	40 HP		1984->2005			1	B7HS-10	2129	BR7HS-10	1098
40	40 HP		1987->		40XMHL	1	BR7HS-10	1098		
40	40 HP		1989->		40XWTL	1	BR7HS-10	1098		
40	40 HP		1989->1997		E40XMHL	1	BR7HS-10	1098		
40	40 HP		1992->		40XWL	1	BR7HS-10	1098		
40	40 HP		2000->		F40FEHDL	0,9	DPR6EA-9	5531		
40	40 HP		2000->2005		F40FEDL	0,9	DPR6EA-9	5531		
40	40 HP		2000->2005		F40FETL	0,9	DPR6EA-9	5531		
40	40 HP		2006->2010		40TLR	1	B7HS-10	2129	BR7HS-10	1098
40	40 HP		2006->2010		40XMHS	1	BR7HS-10	1098		
40	40 HP		2006->2010		F40J,L	0,9	DPR6EB-9	3108		
40	40 HP				AE	0,8	B8HS	5510	BR8HS	4322
40	40 HP				AM	0,8	B8HS	5510	BR8HS	4322
40	40 HP				AR	0,8	B8HS	5510	BR8HS	4322
40	40 HP				BE	0,8	B8HS	5510	BR8HS	4322
40	40 HP				BM	0,8	B8HS	5510	BR8HS	4322
40	40 HP				BR	0,8	B8HS	5510	BR8HS	4322
40	40 HP				C	0,8	B8HS	5510	BR8HS	4322
40	40 HP				CE	0,8	B8HS	5510	BR8HS	4322
40	40 HP				CM	0,8	B8HS	5510	BR8HS	4322
40	40 HP				D	0,8	B8HS	5510	BR8HS	4322
40	40 HP				DM DE DR F FE	0,8	B8HS	5510	BR8HS	4322
40	40 HP				F40C	0,9	DPR5EA-9	2887		
40	40 HP				H	1	B7HS-10	2129	BR7HS-10	1098
40	40 HP				HMOS	1	B8HS-10	5126	BR8HS-10	1134
48	48 HP				A	0,7	B7HS	5110	BR7HS	4122
48	48 HP				B	0,7	B7HS	5110	BR7HS	4122
50	50 HP		1984->2005		50HMHOS	1	BR8HS-10	1134		
50	50 HP		2005->		F50GETL	0,9	DPR6EB-9	3108		
50	50 HP		2005->			0,9	DPR6EB-9	3108		
50	50 HP		2006->2010		50HETOL	1	BR8HS-10	1134		
50	50 HP		2006->2010		50TLR	1	B8HS-10	5126	BR8HS-10	1134
50	50 HP		2006->2010		F50TLR	0,9	DPR6EB-9	3108		
50	50 HP		2006->2010		T50TLR	0,9	DPR6EB-9	3108		
50	50 HP				C	0,8	B8HS	5510	BR8HS	4322
50	50 HP				CE	1	B8HS-10	5126	BR8HS-10	1134
50	50 HP				D	1	B8HS-10	5126	BR8HS-10	1134
50	50 HP				DROS	1	B8HS-10	5126	BR8HS-10	1134
50	50 HP				F50A,B	0,9	DPR6EA-9	5531		
55	55 HP		1979->		AE	1	B8HS-10	5126	BR8HS-10	1134
55	55 HP		1989->1995		55BEDL	1	BR8HS-10	1134		



MARINE • OUTBOARD



Model	Type	Capacity	Year	Cyl	Engine	Gap	Recommended	Stock Code	Alternative	Stock Code
YAMAHA										
55	55 HP		1989->1995		E55CMHL	1	BR8HS-10	1134	YAMAHA	
55	55 HP				AEM AE AM AW	0,8	B8HS	5510	BR8HS	4322
55	55 HP				BE	1	B8HS-10	5126	BR8HS-10	1134
55	55 HP				BM BW	0,8	B8HS	5510	BR8HS	4322
60	60 HP		1978->		AE	0,8	B8HS	5510	BR8HS	4322
60	60 HP		1979->		AE	1	B8HS-10	5126	BR8HS-10	1134
60	60 HP		1995->		FT60DETL	0,9	DPR5EA-9	2887		
60	60 HP		2001->2005		E60HMHDL	1	BR8HS-10	1134		
60	60 HP		2001->2005			1	BR8HS-10	1134		
60	60 HP		2002->		F60A 4 STR	0,9	DPR5EA-9	2887		
60	60 HP		2005->		EFI	0,9	DPR6EB-9	3108		
60	60 HP		2005->		F60 EFI	0,9	DPR6EB-9	3108		
60	60 HP		2005->		T60	0,9	DPR6EB-9	3108		
60	60 HP		2006->		FT60DET	0,9	DPR6EB-9	3108		
60	60 HP		2006->2010		60FETOL	1	BR8HS-10	1134		
60	60 HP		2006->2010		60TLR	1	B8HS-10	5126	BR8HS-10	1134
60	60 HP		2006->2010		F60TJR,TLR	0,9	DPR6EB-9	3108		
60	60 HP		2006->2010		T60TLR	0,9	DPR6EB-9	3108		
60	60 HP				B	1	B8HS-10	5126	BR8HS-10	1134
60	60 HP				BE	1	B8HS-10	5126	BR8HS-10	1134
60	60 HP				CE	1	B8HS-10	5126	BR8HS-10	1134
60	60 HP				CET	1	B8HS-10	5126	BR8HS-10	1134
60	60 HP				DE	1	B8HS-10	5126	BR8HS-10	1134
60	60 HP				F	1	B8HS-10	5126	BR8HS-10	1134
60	60 HP				FEOS	1	B8HS-10	5126	BR8HS-10	1134
60	60 HP				FT60B 4 STR	0,9	DPR5EA-9	2887		
70	70 HP		1984->2010		70BETOL	1	BR8HS-10	1134		
70	70 HP		2006->2010		70LTR	1	B8HS-10	5126	BR8HS-10	1134
70	70 HP		2010->		F70AETL	0,8	LKR7E	1643		
70	70 HP		2010->		F70AETX	0,8	LKR7E	1643		
70	70 HP		2010->		F70AE,TL	0,8	LKR7E	1643		
70	70 HP				B	1	B8HS-10	5126	BR8HS-10	1134
70	70 HP				BEOL	1	B8HS-10	5126	BR8HS-10	1134
75	75 HP		1988->		75A	1	BR8HS-10	1134		
75	75 HP		1994->1999		25AETL	1	BR8HS-10	1134		
75	75 HP		2003->2005		F75	1,1	LFR5A-11	95304		
75	75 HP		2006->2010		F75TLR	1,1	LFR5A-11	95304		
75	75 HP				A	1	B8HS-10	5126	BR8HS-10	1134
75	75 HP				AE	1	B8HS-10	5126	BR8HS-10	1134
75	75 HP				AEM	0,8	B8HS	5510	BR8HS	4322
75	75 HP				AET	1	B8HS-10	5126	BR8HS-10	1134
75	75 HP				AM	0,8	B8HS	5510	BR8HS	4322
75	75 HP				AR	0,8	B8HS	5510	BR8HS	4322
75HP	75 HP		2017->		F75LB	0,9	LKR6E-9N	90151		
80	80 HP		1999->		F80BETX 16V	1,1	LFR5A-11	95304		
80	80 HP		1999 2002->		F80BETL 16V	1,1	LFR5A-11	95304		
80	80 HP				A	1	B8HS-10	5126	BR8HS-10	1134
80	80 HP				AEOL	1	B8HS-10	5126	BR8HS-10	1134
85	85 HP	1140	1989->1996	3	85AEDC	1	BR8HS-10	1134		
85	85 HP		1989->1996		85AETL	1	BR8HS-10	1134		
85	85 HP		1990->		85AEDX	1	BR8HS-10	1134		
85	85 HP		1990->		85AETX	1	BR8HS-10	1134		
85	85 HP				AE	1	B8HS-10	5126	BR8HS-10	1134
85	85 HP				AET	1	B8HS-10	5126	BR8HS-10	1134
90	90 HP		2003->2005		F9	1,1	LFR5A-11	95304		
90	90 HP		2006->		90AETOL	1	BR8HS-10	1134		
90	90 HP		2006->		90AETOX	1	BR8HS-10	1134		
90	90 HP		2006->2010		90TLR	1	B8HS-10	5126	BR8HS-10	1134
90	90 HP		2006->2010		F90TJR,TLR,TXR	1,1	LFR5A-11	95304		
90	90 HP				A	1	B8HS-10	5126	BR8HS-10	1134
90	90 HP				AEOL	1	B8HS-10	5126	BR8HS-10	1134
90 HP	90 HP		2017->		F90JB	0,9	LKR6E-9N	90151		
90 HP	90 HP		2017->		F90LB	0,9	LKR6E-9N	90151		
90 HP	90 HP		2017->		F90XB	0,9	LKR6E-9N	90151		
100	100 HP		1999->2002		F100DETX 16V	1,1	LFR5A-11	95304		
100	100 HP		2000->		F100BETL 16V	1,1	LFR5A-11	95304		
100	100 HP		2000->		F100BETX 16V	1,1	LFR6A-11	3672		
100	100 HP		2001->		F100DETL 16V	1,1	LFR5A-11	95304		
115	115 HP		1990->		115C	1	BR8HS-10	1134		
115	115 HP		2000->2005		F115 V4	1,1	LFR6A-11	3672		
115	115 HP		2000->2005		V4	1,1	LFR6A-11	3672		
115	115 HP		2000->2010		F115AETL 16V	1,1	LFR6A-11	3672		

MARINE



MARINE • OUTBOARD



Model	Type	Capacity	Year	Cyl	Engine	Gap	Recommended	Stock Code	Alternative	Stock Code
YAMAHA										
115	115 HP		2001->		F115AETX 16V	1,1	LFR6A-11	3672		
115	115 HP		2001->		FL115AETX 16	1,1	LFR6A-11	3672		
115	115 HP		2006->		115 CETOL	1	BR8HS-10	1134		
115	115 HP		2006->2010		115TLR, TXR	1	BR8HS-10	1134		
115	115 HP		2006->2010		E115AETL	1	BR8HS-10	1134		
115	115 HP		2006->2010		E115AETX	1	BR8HS-10	1134		
115	115 HP		2006->2010		F115TJR, TLR, TXR	1,1	LFR6A-11	3672		
115	115 HP		2006->2010		LF115TXR	1,1	LFR6A-11	3672		
115	115 HP				115B	1	BR8HS-10	1134		
115	115 HP				AE	1	B8HS-10	5126	BR8HS-10	1134
115	115 HP				AETOL BETO AET A	1	B8HS-10	5126	BR8HS-10	1134
125	125 HP				P125 A	0,6	B6HS	4510	BR6HS	3922
125	125 HP				P125 AG	0,6	B6HS	4510	BR6HS	3922
130	130 HP		1988->2004		V 4	1	BR8HS-10	1134		
130	130 HP		1990->		130BETOL	1	BR9HS-10	4551		
140	140 HP		1988->		140B	1	BR9HS-10	4551		
140	140 HP				BETO	1	B8HS-10	5126	BR8HS-10	1134
150	150 HP		1986->		A	1	B8HS-10	5126	BR8HS-10	1134
150	150 HP		1988->		150A	1	BR8HS-10	1134		
150	150 HP		1988->		L 150A	1	BR8HS-10	1134		
150	150 HP		1990->		150C	1	BR8HS-10	1134		
150	150 HP		1990->		L 150FETOX	1	BR8HS-10	1134		
150	150 HP		2002->		Z150QETOL HPDI	1	BR8HS-10	1134		
150	150 HP		2004->		F150AETL 16V	1,1	LFR6A-11	3672		
150	150 HP		2004->		FL150AETX	1,1	LFR6A-11	3672		
150	150 HP		2004->2005		F150	1,1	LFR5A-11	95304		
150	150 HP		2004->2005		F150AETX	1,1	LFR5A-11	95304		
150	150 HP		2004->2005		LF 150	1,1	LFR5A-11	95304		
150	150 HP		2006->		150 FETOL	1	BR8HS-10	1134		
150	150 HP		2006->		150 FETOX	1	BR8HS-10	1134		
150	150 HP		2006->2010		150TXR	1	BR7HS-10	1098		
150	150 HP		2006->2010		F150TJR	1,1	LFR5A-11	95304		
150	150 HP		2006->2010		LF150TXR	1,1	LFR5A-11	95304		
150	150 HP		2006->2010		LZ150TXR	0,8	BKR6EKU	6993		
150	150 HP		2006->2010		V150TLR	1	BR7HS-10	1098		
150	150 HP		2006->2010		VZ150TLR	0,8	BKR6EKU	6993		
150	150 HP		2006->2010		Z150TXR	0,8	BKR6EKU	6993		
150	150 HP				AETOL	1	B8HS-10	5126	BR8HS-10	1134
175	175 HP		2002->2005		VZ175	0,8	BKR7EKU	5881		
175	175 HP		2006->2010		VZ175TLR	0,8	BKR7EKU	5881		
175	175 HP		2006->2010		Z175TXR	0,8	BKR7EKU	5881		
200	200 HP		1987->		200AETX	1	BR8HS-10	1134		
200	200 HP		1987->1995		200AETL	1	BR8HS-10	1134		
200	200 HP		1988->		200A	1	BR8HS-10	1134		
200	200 HP		1990->		200B	1	BR8HS-10	1134		
200	200 HP		1990->		L 200B	1	BR8HS-10	1134		
200	200 HP		1999->		Z200PETOL HPDI	1	BR8HS-10	1134		
200	200 HP		1999->2001		L200AETX	1	BR8HS-10	1134		
200	200 HP		1999->2005		200FETOL	1	BR8HS-10	1134		
200	200 HP		1999->2005		200FETOX	1	BR8HS-10	1134		
200	200 HP		1999->2005		SX200	0,8	BR8HS	4322		
200	200 HP		2000->2001		Z200TX	1,1	BKR7EIX	2667	BCPR7ES	93606
200	200 HP		2000->2005		VX200	1	BR8HS-10	1134		
200	200 HP		2002->		Z200 F1	0,8	BKR7EKU	5881		
200	200 HP		2002->			1,1	LFR5A-11	95304		
200	200 HP		2002->2005		F200BETX	1,1	LFR5A-11	95304		
200	200 HP		2005->		L200 FETOX	1	BR8HS-10	1134		
200	200 HP		2005->		VX200D	1	BR8HS-10	1134		
200	200 HP		2006->2010		F200TXR	1,1	LFR5A-11	95304		
200	200 HP		2006->2010		LF200TXR	1,1	LFR5A-11	95304		
200	200 HP		2006->2010		LZ200TXR	0,8	BKR7EKU	5881		
200	200 HP		2006->2010		Z200TLR, TXR	0,8	BKR7EKU	5881		
200	200 HP		2008->		F250DETC	1,1	LFR6A-11	3672		
200	200 HP				A	1	B8HS-10	5126	BR8HS-10	1134
200	200 HP				AETOL	1	B8HS-10	5126	BR8HS-10	1134
225	225 HP		1988->		225A	1	BR9HS-10	4551		
225	225 HP		1990->		225B	1	BR9HS-10	4551		
225	225 HP		1997->		Z225HETOL HPDI	1	BR9HS-10	4551		
225	225 HP		2002->2005		F225DETC	1,1	LFR5A-11	95304		
225	225 HP		2005->		F225AETU	1,1	LFR6A-11	3672		
225	225 HP		2005->		FL225AETU	1,1	LFR6A-11	3672		
225	225 HP		2006->		F225AETX	1,1	LFR6A-11	3672		



MARINE • OUTBOARD



Model	Type	Capacity	Year	Cyl	Engine	Gap	Recommended	Stock Code	Alternative	Stock Code
YAMAHA										
225	225 HP		2006->		F225CETL 24V	1,1	LFR6A-11	3672		
225	225 HP		2006->		FL225AETX	1,1	LFR6A-11	3672		
225	225 HP		2006->2010		F225TLR	1,1	LFR6A-11	3672		
225	225 HP		2006->2010		F225TUR, TXR	1,1	LFR5A-11	95304		
225	225 HP		2006->2010		LF225TUR, TXR	1,1	LFR5A-11	95304		
225	225 HP		2006->2010		VZ225HTLR, TLR	0,8	BKR6EKU	6993		
225	225 HP				AETO	1	B8HS-10	5126	BR8HS-10	1134
250	250 HP		2003->		FL250AETX	1,1	LFR6A-11	3672		
250	250 HP		2003->2005		F250AETX	1,1	LFR6A-11	3672		
250	250 HP		2005->		F250AETU	1,1	LFR6A-11	3672		
250	250 HP		2005->		F250CETL	1,1	LFR5A-11	95304		
250	250 HP		2005->		FL250AETU	1,1	LFR6A-11	3672		
250	250 HP		2006->		F250BETU	1,1	LFR6A-11	3672		
250	250 HP		2006->		FL250BETU	1,1	LFR6A-11	3672		
250	250 HP		2006->2010		F250BTUR, BTXR	1,1	LFR6A-11	3672		
250	250 HP		2006->2010		F250TUR, TXR	1,1	LFR6A-11	3672		
250	250 HP		2006->2010		LF250BTUR, BTXR	1,1	LFR6A-11	3672		
250	250 HP		2006->2010		LZ250TUR, TXR	0,8	BKR6EKU	6993		
250	250 HP		2006->2010		VZ250FTLR, TLR	0,8	BKR6EKU	6993		
250	250 HP		2006->2010		Z250TUR, TXR	0,8	BKR6EKU	6993		
300	300 HP	2300	2005->	6	AETO	0,8	BKR6EKU	6993		
300	300 HP		2004->2005		VZ300	0,8	BKR6EKU	6993		
300	300 HP		2006->2010		F300TUR, TXR	1,1	LFR6A-11	3672		
300	300 HP		2006->2010		LF300TUR, TXR	1,1	LFR6A-11	3672		
300	300 HP		2006->2010		LZ300TUR, TXR	0,8	BKR6EKU	6993		
300	300 HP		2006->2010		VZ300BTLR, LTR	0,8	BKR6EKU	6993		
300	300 HP		2006->2010		Z300TUR, TXR	0,8	BKR6EKU	6993		
350	350 HP		2005->		F350AETU	1,1	LFR6A-11	3672		
350	350 HP		2005->		FL350AETU	1,1	LFR6A-11	3672		
350	350 HP		2006->2010		F350TUR, TXR	1,1	LFR6A-11	3672		
350	350 HP		2006->2010		LF350TUR, TXR	1,1	LFR6A-11	3672		
500	500 HP				WR	0,7	B7HS	5110	BR7HS	4122
500	500 HP				WR	0,7	B7HS	5110	BR7HS	4122



GARDEN EQUIPMENT • BLOWER



Model	Type	Capacity	Year	Cyl	Engine	Gap	Recommended	Stock Code	Alternative	Stock Code	
HOMELITE										HOMELITE	
25						0,7	BPMR7A	4626			
RYOBI										RYOBI	
280R 310BVR RGBV3100	BLOWER					0,7	BPM6F	5950			
STIHL										STIHL	
BG	45,55,65,85					0,7	BPMR7A	4626			



GARDEN EQUIPMENT • BRUSH CUTTER



Model	Type	Capacity	Year	Cyl	Engine	Gap	Recommended	Stock Code	Alternative	Stock Code
-------	------	----------	------	-----	--------	-----	-------------	------------	-------------	------------

DOLMAR										
DOLMAR										
BC212						0,8	BM6F	6221		
BC250						0,7	BPM6F	5950		
LT210						0,8	BM6F	6221		
LT250						0,7	BMR7A	4226		
MS250						0,7	BMR7A	4226		
MS250-4						0,8	CMR6A	1223		
MS30C						0,7	BPMR7A	4626		

GREEN MACHINE										
1600	32					0,6	BM6A	5921	BMR6A	7421
1700	17					0,6	BM6A	5921	BMR6A	7421

HOMELITE										
BCH33,B,BCH40,BCH48	BRUSH CUTTER					0,6	BM6A	5921	BMR6A	7421
D830SB						0,6	BM6F	6221		
E300	TRIMMER					0,8	CM6	5812		
HBC	30					0,6	BM6F	6221		
HBC30,B	BRUSH CUTTER					0,7	BPMR7A	4626		
HT17 HT21	HEDGE TRIMMER					0,7	BPMR7A	4626		
HX16	HEDGE TRIMMER					0,7	BPMR7A	4626		
PBC3800						0,6	BM6A	5921	BMR6A	7421
PBC4000						0,6	BM6A	5921	BMR6A	7421
ST	175G					0,6	BM6F	6221		
ST	200					0,6	BM6F	6221		
ST	210					0,6	BM6F	6221		
ST155 ST385	BRUSH CUTTER					0,7	BPMR7A	4626		
SX	135					0,6	BM6F	6221		
TRIMLITE						0,6	BM6F	6221		

HONDA										
STRING TRIMMER	TRIMMER					0,7	CMR5H	7599		
UM21,UM2160,UM536,K1	BRUSH CUTTER					0,8	BPR5ES	94084		
UMK 431	D,J,L3E,LE,LEB,U3E,UE,UEB,L3E,U3E,UE,LT4					0,7	C5HSB	6452	CR5HSB	6535
UMK422	D,J,LNC,LNU,LT4,LTE,S,UE,UN4C,UNU,UT4E					0,7	C5HSB	6452	CR5HSB	6535
UMK422LTE						0,8	CR5HSB	6535		
UMK422,UMK431	BRUSH CUTTER					0,7	C5HSB	6452	CR5HSB	6535
UMK425	BRUSH CUTTER					0,7	CMR5H	7599		
UMK435	BRUSH CUTTER					0,7	CMR5H	7599		

HUSQVARNA										
120L	BRUSH CUTTER					0,7	BMR7A	4226		
132HBV	BRUSH CUTTER					0,7	BMR7A	4226		
165R	RX					0,7	BPM7A	7321	BPMR7A	4626
16H,18H,24H,26H,26RJ	BRUSH CUTTER					0,7	BMR7A	4226		
224R	RX					0,7	BPM7A	7321	BPMR7A	4626
225DR,RT - 232LR	BRUSH CUTTER					0,7	BMR7A	4226		
232R						0,7	BPMR7A	4626		
235R						0,7	BPMR7A	4626		
235,24						0,7	BMR7A	4226		
240R						0,7	BPMR7A	4626		
244	RX					0,7	BPMR7A	4626		
245,25						0,7	BMR7A	4226		
250	RX					0,7	BPMR7A	4626		
250R						0,7	BPMR7A	4626		
265						0,7	BMR7A	4226		
265RX						0,7	BPMR7A	4626		
323L						0,7	BPMR7A	4626		
323R						0,7	BPMR7A	4626		
325CX						0,7	BPMR7A	4626		

KAAZ										
KAWASAKI	KT17J					0,7	BM7A	6521	BMR7A	4226
KAWASAKI	TD40					0,7	BM7A	6521	BMR7A	4226



GARDEN EQUIPMENT • BRUSH CUTTER



Model	Type	Capacity	Year	Cyl	Engine	Gap	Recommended	Stock Code	Alternative	Stock Code
-------	------	----------	------	-----	--------	-----	-------------	------------	-------------	------------

KAWASAKI						KAWASAKI				
TJ53			2012->			0,8	BPMR8Y	2218		

KIORITZ (ECHO)						KIORITZ (ECHO)				
GT-2010,GT-2200						0,7	BPM7A	7321	BPMR7A	4626
RM-310,RM-311						0,7	BPM7A	7321	BPMR7A	4626
RM-356						0,7	BPMR7A	4626		
RMA-2530						0,7	BPMR7A	4626		
SRA-2530						0,7	BPM7A	7321	BPMR7A	4626
SRM-140D						0,6	BM6A	5921	BMR6A	7421
SRM-1500						0,7	BPM7A	7321	BPMR7A	4626
SRM-2000						0,7	BPM7A	7321	BPMR7A	4626
SRM-2010						0,7	BPM7A	7321	BPMR7A	4626
SRM-2090						0,7	BPM7A	7321	BPMR7A	4626
SRM-2100						0,7	BPM7A	7321	BPMR7A	4626
SRM-2200						0,7	BPM7A	7321	BPMR7A	4626
SRM-2500						0,7	BPM7A	7321	BPMR7A	4626
SRM-250E						0,7	BPM7A	7321	BPMR7A	4626
SRM-2605						0,7	BPMR7A	4626		
SRM-2655						0,7	BPMR7A	4626		
SRM-3000						0,7	BPM7A	7321	BPMR7A	4626
SRM-300AE						0,6	BM6A	5921	BMR6A	7421
SRM-300E						0,6	BM6A	5921	BMR6A	7421
SRM-3010						0,7	BPM7A	7321	BPMR7A	4626
SRM-302B0X						0,6	BM6A	5921	BMR6A	7421
SRM-3100						0,7	BPM7A	7321	BPMR7A	4626
SRM-310,SRM310E						0,7	BPM7A	7321	BPMR7A	4626
SRM-3155						0,7	BPMR7A	4626		
SRM-3400						0,7	BPM7A	7321	BPMR7A	4626
SRM-3600						0,7	BPMR7A	4626		
SRM-3605						0,7	BPMR7A	4626		
SRM-3800						0,7	BPMR7A	4626		
SRM-400AE,E						0,7	BPM7A	7321	BPMR7A	4626
SRM-400BE						0,7	BPM7A	7321	BPMR7A	4626
SRM-400E						0,7	BPMR7A	4626		
SRM-401						0,6	BM6A	5921	BMR6A	7421
SRM-402DE						0,7	BPM7A	7321	BPMR7A	4626
SRM-4600						0,7	BPMR7A	4626		
SRM-501DE						0,6	BM6A	5921	BMR6A	7421

KOMATSU ZENOAH						KOMATSU ZENOAH				
BC340	FWM					0,7	BPM6A	7021	BPMR6A	6726
BC430	FWM					0,7	BPM6A	7021	BPMR6A	6726

MAKITA						MAKITA				
RBC220,221,230,250,251	BRUSH CUTTER					0,7	BM7A	6521	BMR7A	4226
RBC260,261	BRUSH CUTTER					0,7	BPM7A	7321	BPMR7A	4626
RBC310,311	BRUSH CUTTER					0,7	BM7A	6521	BMR7A	4226
RBC411	BRUSH CUTTER					0,7	BPM7A	7321	BPMR7A	4626
RBC520	BRUSH CUTTER					0,7	BM7A	6521	BMR7A	4226
RBK411	BRUSH CUTTER					0,7	BPM7A	7321	BPMR7A	4626
RST250	BRUSH CUTTER					0,7	BM7A	6521	BMR7A	4226

MCCULLOCH						MCCULLOCH				
BP	38 AV					0,6	BM6A	5921	BMR6A	7421
SUP. MAC	38 AV					0,6	BM6A	5921	BMR6A	7421

PARTNER						PARTNER				
B	440					0,7	BM7A	6521	BMR7A	4226

ROBIN						ROBIN				
BH2500						0,8	CMR7A	7543	CMR7H	3066
EC02			2 STROKE			0,7	BM7A	6521	BMR7A	4226
EC03			2 STROKE			0,7	B7HS	5110	BR7HS	4122
EC04			2 STROKE			0,7	B7HS	5110	BR7HS	4122
EC04			2 STROKE			0,8	B9ES	2611	BR9ES	5722



GARDEN EQUIPMENT • BRUSH CUTTER



Model	Type	Capacity	Year	Cyl	Engine	Gap	Recommended	Stock Code	Alternative	Stock Code
-------	------	----------	------	-----	--------	-----	-------------	------------	-------------	------------

ROBIN										
EC06					2 STROKE	0,6	B6HS	4510	BR6HS	3922
NB03	30					0,6	B6HS	4510	BR6HS	3922
NB04	40					0,6	B6HS	4510	BR6HS	3922

RYOBI										
2075RC	TRIMMER	25.0				0,7	BPM7A	7321	BPMR7A	4626
2090RC	TRIMMER	31.0				0,7	BMR4A	5728		
310RT	TRIMMER	31.0				0,7	BM7A	6521	BMR7A	4226
330RB	TRIMMER	31.0				0,7	BPM6F	5950		
340RB	TRIMMER	31.0				0,7	BPM6F	5950		
700R,704R,704, RVP,705R	TRIMMER	31.0				0,7	BPM6F	5950		
710R, 720R	TRIMMER	31.0				0,8	BM6F	6221		
740R, 750R	TRIMMER	31.0				0,7	BMR6A	7421		
780R	TRIMMER	31.0				0,7	BPM6F	5950		
790R, 790PR	TRIMMER	31.0				0,7	BPM6F	5950		
865R	TRIMMER	31.0				0,8	BM6F	6221		
885R	TRIMMER	31.0				0,7	BPM6F	5950		
RB2540	TRIMMER	25.0				0,7	BPM7A	7321	BPMR7A	4626
RCS3540C	TRIMMER					0,8	CMR7H	3066		

SACHS - DOLMAR										
BC	330					0,7	BPM6F	5950		
BC	400					0,7	BPM6A	7021	BPMR6A	6726

SOLO										
105L						0,7	BPMR6A	6726		
106B						0,7	BPMR6A	6726		
106L						0,7	BPMR6A	6726		
118, 119, 127, 130	TRIMMER					0,7	BPMR6A	6726		
120, 121, 124, 126, 128	TRIMMER					0,7	BPMR7A	4626		
123, 125	TRIMMER					0,6	BM6F	6221		
129BTS						0,7	BPMR6A	6726		
135E136	TRIMMER					0,6	BM6A	5921	BMR6A	7421
SOLO 40	T200					0,6	BM6A	5921	BMR6A	7421
SOLO 50	T240					0,6	BM6A	5921	BMR6A	7421

STIHL										
1106						0,7	BPM6A	7021	BPMR6A	6726
1106(8.5PS)						0,7	BPM7A	7321	BPMR7A	4626
1108, 1109(6.5PS)						0,7	BPM6A	7021	BPMR6A	6726
1111, 1112, 1113						0,7	BPM6A	7021	BPMR6A	6726
1401						0,6	AB-6	2910		
4202						0,7	BPM6A	7021	BPMR6A	6726
BG60, HS60						0,7	BMR6A	7421		
BG72						0,7	BPMR7A	4626		
BR106, BR320, BR400						0,7	BPMR7A	4626		
FC100						0,8	CMR6H	3365		
FC110						0,8	CMR6H	3365		
FS	160					0,7	BPMR7A	4626		
FS	353					0,6	BM6A	5921	BMR6A	7421
FS	38					0,7	BMR6A	7421		
FS	410					0,6	BM6A	5921	BMR6A	7421
FS	85					0,7	BPMR7A	4626		
FS	86					0,6	BM6A	5921	BMR6A	7421
FS	90					0,6	BM6A	5921	BMR6A	7421
FS	96					0,6	BM6A	5921	BMR6A	7421
FS110						0,8	CMR6H	3365		
FS80AVRE, FS90AVE						0,6	BM6A	5921	BMR6A	7421
FS80E, FS80RE, FS80AVE						0,6	BM6A	5921	BMR6A	7421
KM100R						0,8	CMR6H	3365		
SR320, SR400						0,7	BPMR7A	4626		

STILETTO										
BRIGGS & STRATTON	2HP					0,6	BM6A	5921	BMR6A	7421

GARDEN EQUIPMENT



GARDEN EQUIPMENT • CHAINSAW



Model	Type	Capacity	Year	Cyl	Engine	Gap	Recommended	Stock Code	Alternative	Stock Code
-------	------	----------	------	-----	--------	-----	-------------	------------	-------------	------------

AGWAY										
75						0,6	BMR6A	7421		
754						0,6	B7S	3710		
PL14						0,8	BMR7A	4226		
PL16	PL6					0,8	BMR7A	4226		
PL5						0,8	BMR7A	4226		

ALLIS CHALMERS										
195						0,6	BMR6A	7421		
295						0,6	BMR6A	7421		
65						0,6	BM6A	5921	BMR6A	7421
75						0,6	BM6A	5921	BMR6A	7421
95						0,6	BM6A	5921	BMR6A	7421

ALPINA										
0-70				1		0,7	BPM6A	7021	BPMR6A	6726
0-70, 0-70S						0,7	BPM6A	7021	BPMR6A	6726
160 GREEN						0,6	BM6A	5921	BMR6A	7421
200 PROF						0,7	B6S	3510		
A-35, A-40, A-90						0,7	BPM6A	7021	BPMR6A	6726
FOREST 120						0,7	BPM6A	7021	BPMR6A	6726
MS540I, 600I						0,7	BPM6A	7021	BPMR6A	6726
MS, P34, P400, P450						0,7	BPMR7A	4626		
PRO	45, 55, 65			1		0,7	BPM6A	7021	BPMR6A	6726
PROF 34						0,7	BPM7A	7321	BPMR7A	4626
PROF 90, 120						0,7	BPM6A	7021	BPMR6A	6726

DAYTON										
22-461, 462, 463, 463B						0,6	BM6A	5921	BMR6A	7421
22-573, 760, 970, 970B						0,6	BM6A	5921	BMR6A	7421
22-971						0,6	BM6A	5921	BMR6A	7421
42-022, 023, 023B, 109C						0,6	BM6A	5921	BMR6A	7421
42-251A						0,7	BPM6A	7021	BPMR6A	6726
42-252						0,7	BM7A	6521	BMR7A	4226

DOLMAR										
100, 100SUPER						0,7	BPM6F	5950		
101, 103, 104						0,7	BMR6A	7421		
102						0,7	BPM6F	5950		
105						0,6	BM6A	5921	BMR6A	7421
106						0,7	BMR6A	7421		
108						0,6	BM6A	5921	BMR6A	7421
109						0,7	BPMR7A	4626		
110 1986.6						0,7	BPM6F	5950		
110 1986.7						0,7	BPMR7A	4626		
110I						0,7	BPMR7A	4626		
111						0,7	BPMR7A	4626		
112						0,7	BPM6A	7021	BPMR6A	6726
112 SUPER						0,7	BPMR7A	4626		
113, 113SUPER						0,7	BPMR7A	4626		
114						0,7	BPM7A	7321	BPMR7A	4626
115, 115I						0,7	BPMR7A	4626		
116 SI						0,7	BPMR7A	4626		
117						0,7	BPM7A	7321	BPMR7A	4626
118S, 119						0,7	BPM7A	7321	BPMR7A	4626
120S 1987.2						0,7	BPMR7A	4626		
121						0,7	BPMR7A	4626		
122, 122S, 122SL						0,7	BM7A	6521	BMR7A	4226
123						0,7	BPMR7A	4626		
128KMS4						0,7	BM7A	6521	BMR7A	4226
133, 133S						0,7	BPMR7A	4626		
143						0,7	BPMR7A	4626		
152						0,6	BM6A	5921	BMR6A	7421
153						0,7	BPMR7A	4626		
160, 166, 309, 310, 343						0,7	BPMR7A	4626		
308						0,7	BPM7A	7321	BPMR7A	4626
309						0,7	BPMR6A	6726		
343						0,7	BPMR6A	6726		
PS-33						0,7	BPM6F	5950		



GARDEN EQUIPMENT • CHAINSAW



Model	Type	Capacity	Year	Cyl	Engine	Gap	Recommended	Stock Code	Alternative	Stock Code
DOLMAR						DOLMAR				
PS-340, 341, 400, 401						0,7	BPM6F	5950		
PS-410 33						0,7	BPM6F	5950		
PS-411 33						0,7	BPM6F	5950		
PS-6000I, 6000IH						0,7	BPMR7A	4626		
PS-6800I, 6800IH						0,7	BPMR7A	4626		
PS-9000						0,7	BPMR7A	4626		
S6000						0,7	BPMR7A	4626		
ECHO						ECHO				
CS-100						0,7	B7S	3710		
CS-1001VL						0,7	BMR6A	7421		
CS-1200						0,7	BPM7A	7321	BPMR7A	4626
CS-1200VLS						0,7	BPMR7A	4626		
CS-200E						0,7	BM6A	5921	BMR6A	7421
CS-2600						0,7	BPMR7A	4626		
CS-2700ES						0,7	BPMR7A	4626		
CS-2800						0,7	BPM7A	7321	BPMR7A	4626
CS-280E						0,7	BPM6A	7021	BPMR6A	6726
CS-280EG						0,7	BMR6A	7421		
CS-280EVL						0,7	BMR6A	7421		
CS-285EVL						0,7	BMR6A	7421		
CS-2900						0,7	BPM7A	7321	BPMR7A	4626
CS-290EVL						0,7	BMR6A	7421		
CS-3000						0,7	BPM7A	7321	BPMR7A	4626
CS-300EVL						0,7	BPMR6A	6726		
CS-302						0,7	BM6A	5921	BMR6A	7421
CS-302S						0,7	BM6A	5921	BMR6A	7421
CS-304VL						0,7	BM6A	5921	BMR6A	7421
CS-3050				30.1		0,6	BPM7A	7321	BPMR7A	4626
CS-30EVL						0,7	BMR6A	7421		
CS-315						0,7	BM6A	5921	BMR6A	7421
CS-320EVL						0,7	BMR6A	7421		
CS-330EVL						0,7	BMR6A	7421		
CS-332						0,7	BPMR7A	4626		
CS-332EV						0,7	BPM7A	7321	BPMR7A	4626
CS-3400						0,7	BPM7A	7321	BPMR7A	4626
CS-3450						0,8	BPMR7A	4626		
CS-3500						0,7	BPMR7A	4626		
CS-351VL						0,7	BMR6A	7421		
CS-3600						0,7	BPM7A	7321	BPMR7A	4626
CS-360EVL						0,7	BPM6A	7021	BPMR6A	6726
CS-3900						0,7	BPM6A	7021	BPMR6A	6726
CS-4000						0,7	BPM7A	7321	BPMR7A	4626
CS-4000						0,7	BPMR7A	4626		
CS-4000EVL						0,7	BPMR7A	4626		
CS-400EVL						0,7	BPM6A	7021	BPMR6A	6726
CS-4200						0,7	BPMR7A	4626		
CS-4400						0,7	BPM7A	7321	BPMR7A	4626
CS-4400						0,7	BPM7A	7321	BPMR7A	4626
CS-440EVL						0,7	BPMR7A	4626		
CS-4500						0,7	BPM7A	7321	BPMR7A	4626
CS-451VL						0,7	BMR6A	7421		
CS-4600						0,7	BPM7A	7321	BPMR7A	4626
CS-4601						0,7	BPM7A	7321	BPMR7A	4626
CS-5000						0,7	BPM7A	7321	BPMR7A	4626
CS-500VL						0,7	BPM6A	7021	BPMR6A	6726
CS-510		50		1		0,8	BPM7A	7321	BPMR7A	4626
CS-5100						0,7	BPMR7A	4626		
CS-510EVL						0,7	BPMR7A	4626		
CS-5500						0,7	BPM7A	7321	BPMR7A	4626
CS-5501						0,7	BPM7A	7321	BPMR7A	4626
CS-600						0,7	BMR6A	7421		
CS-601						0,7	BMR6A	7421		
CS-602VL						0,7	BPMR7A	4626		
CS-60S						0,7	BMR6A	7421		
CS-650VL						0,7	BPMR7A	4626		
CS-660EVL						0,7	BPMR7A	4626		
CS-6700						0,7	BPM7A	7321	BPMR7A	4626
CS-6701						0,7	BPM7A	7321	BPMR7A	4626
CS-6702						0,7	BPM7A	7321	BPMR7A	4626
CS-701VL						0,7	BMR6A	7421		

GARDEN EQUIPMENT



GARDEN EQUIPMENT • CHAINSAW



Model	Type	Capacity	Year	Cyl	Engine	Gap	Recommended	Stock Code	Alternative	Stock Code
-------	------	----------	------	-----	--------	-----	-------------	------------	-------------	------------

ECHO										ECHO
CS-702VL						0,7	BPMR7A	4626		
CS-750VL						0,7	BPMR7A	4626		
CS-8000						0,7	BPM7A	7321	BPMR7A	4626
CS-8001						0,7	BPM7A	7321	BPMR7A	4626
CS-80Z						0,7	BM6A	5921	BMR6A	7421
CS-900EVL						0,7	BPMR7A	4626		
CS350TES						0,8	BPM7A	7321	BPMR7A	4626
CS8002						0,6	BPMR7A	4626		
CSB-280						0,7	BMR6A	7421		
CSB-330EVL						0,7	BMR6A	7421		
HC-1000						0,7	BM6A	5921	BMR6A	7421
HC-1500						0,7	BM6A	5921	BMR6A	7421
HC-160						0,7	BM6A	5921	BMR6A	7421
HC-210						0,7	BM6A	5921	BMR6A	7421
QV-6700						0,7	BPMR7A	4626		
QV-8000						0,7	BPMR7A	4626		
S-290						0,7	BM6A	5921	BMR6A	7421

HOMELITE										HOMELITE
150						0,6	BM6F	6221		
190						0,6	BM6F	6221		
360	SL					0,7	BPM6F	5950		
410	SL					0,7	BPM6F	5950		
1000						0,7	BPMR7A	4626		
1050						0,7	BM7A	6521	BMR7A	4226
1050, 1130G, 2100S, 3100G						0,7	BM7A	6521	BMR7A	4226
135, 650, 750						0,7	BM7A	6521	BMR7A	4226
150, 190						0,6	BM6F	6221		
205, 252						0,7	BPMR7A	4626		
240						0,6	BM6F	6221		
240SL, 330SL, 360SL						0,7	BPM6F	5950		
240, 245HG, SL, 410, 540						0,8	BM6F	6221		
290, 340						0,7	BPMR7A	4626		
410SL						0,7	BPM6F	5950		
750W						0,7	BM7A	6521	BMR7A	4226
C72						0,7	B6S	3510		
DM-20						0,7	BM7A	6521	BMR7A	4226
DM-40						0,7	BPM6F	5950		
DM-54						0,7	BPM6F	5950		
I3350B, I3850B						0,7	BPMR7A	4626		
SUPER	XL-AO					0,7	BM7A	6521	BMR7A	4226
SUPER	XL925					0,7	BM7A	6521	BMR7A	4226
SUPER 2						0,6	BM6F	6221		
SUPER 2						0,6	BM6F	6221		
SUPER WIZ 55, 66, 80						0,7	B6S	3510		
SUPER XL-AO XL925						0,7	BM7A	6521	BMR7A	4226
SXL-922SL						0,7	BMR7A	4226		
V1	944					0,7	BM7A	6521	BMR7A	4226
V1	955					0,7	BM7A	6521	BMR7A	4226
V1-130SL						0,7	B6S	3510		
V1-944, V1-955						0,7	BM7A	6521	BMR7A	4226
V1-SUPER2, SUPER2SL						0,6	BM6F	6221		
XL	25					0,6	BM6F	6221		
XL AO						0,7	BMR7A	4226		
XL XL-2						0,6	BM6F	6221		
XL100A						0,6	BM6A	5921	BMR6A	7421
XL12						0,6	BM6A	5921	BMR6A	7421
XL123, XL600F, XL923, XL923A						0,7	BM7A	6521	BMR7A	4226
XL76						0,7	B6S	3510		
XL98A						0,7	BM7A	6521	BMR7A	4226
XLBC-4	BRUSH CUTTER					0,7	BM7A	6521	BMR7A	4226

HONDA										HONDA
ATC90						0,7	D8HS	7012		



GARDEN EQUIPMENT • CHAINSAW



Model	Type	Capacity	Year	Cyl	Engine	Gap	Recommended	Stock Code	Alternative	Stock Code
-------	------	----------	------	-----	--------	-----	-------------	------------	-------------	------------

HUSQVARNA HUSQVARNA

163	S					0,7	BPM6A	7021	BPMR6A	6726
165	R					0,7	BPM6A	7021	BPMR6A	6726
180	S					0,7	BPM6A	7021	BPMR6A	6726
185	CD					0,7	BM7A	6521	BMR7A	4226
244	R					0,7	BPM6A	7021	BPMR6A	6726
260	CD					0,7	BPM6A	7021	BPMR6A	6726
266	SE,SG,XP					0,7	BPM6A	7021	BPMR6A	6726
281	XP					0,7	BPM6A	7021	BPMR6A	6726
133SE, 133SG						0,7	BM7A	6521	BMR7A	4226
140						0,7	BPM7A	7321	BPMR7A	4626
140R, 140S, 160S						0,7	BPM6A	7021	BPMR6A	6726
154SE, 154SG						0,7	BM7A	6521	BMR7A	4226
162E, 162FE, 162FG						0,7	BPM6A	7021	BPMR6A	6726
162S						0,7	BPM7A	7321	BPMR7A	4626
162SE, 162SG						0,7	BPM6A	7021	BPMR6A	6726
163	CD					0,7	BPM6A	7021	BPMR6A	6726
181						0,7	BPM7A	7321	BPMR7A	4626
1R, 36R, 61D						0,7	BPM7A	7321	BPMR7A	4626
2100	CD					0,7	BM7A	6521	BMR7A	4226
234SE, 234SG						0,7	BPM6A	7021	BPMR6A	6726
238SE, 238SG						0,7	BPM6A	7021	BPMR6A	6726
240S, 240SE, 240SG						0,7	BPM6A	7021	BPMR6A	6726
257						0,7	BPMR7A	4626		
263CD, 280CD, 280S, 280G						0,7	BPM6A	7021	BPMR6A	6726
268, 272						0,7	BMR7A	4226		
285CD						0,7	BM7A	6521	BMR7A	4226
340						0,7	BPMR7A	4626		
340SE, 340SG						0,7	BPM6A	7021	BPMR6A	6726
344FE, 344FG						0,7	BPM6A	7021	BPMR6A	6726
345						0,7	BPMR7A	4626		
353						0,7	BPMR7A	4626		
365, 371						0,7	BMR7A	4226		
371XP, 372XP						0,7	BPMR7A	4626		
380CD, 380K, 380S						0,7	BPM6A	7021	BPMR6A	6726
385XP						0,7	BPMR7A	4626		
39	R					0,7	BPM6A	7021	BPMR6A	6726
395XP						0,7	BPMR7A	4626		
40P 44						0,7	BPM6A	7021	BPMR6A	6726
444FE, 444FG, 444SE, 444SG						0,7	BPM6A	7021	BPMR6A	6726
480CD, 480K						0,7	BPM6A	7021	BPMR6A	6726
51						0,7	BMR7A	4226		
55, 55 RANCHER						0,7	BPMR7A	4626		
61	P					0,7	BPM6A	7021	BPMR6A	6726
61P						0,7	BPMR6A	6726		
65, 65K, 77SS						0,7	BPM6A	7021	BPMR6A	6726
A100						0,7	BM7A	6521	BMR7A	4226
A65						0,7	BPM6A	7021	BPMR6A	6726
A70						0,7	BM7A	6521	BMR7A	4226
A77						0,7	BPM6A	7021	BPMR6A	6726
B65, B77						0,7	BPM6A	7021	BPMR6A	6726
F65						0,7	BPM6A	7021	BPMR6A	6726
F70						0,6	BM6A	5921	BMR6A	7421
G65						0,7	BPM6A	7021	BPMR6A	6726
HUSKY 32, 35, 35VR, 38, 38VR						0,7	BPM6A	7021	BPMR6A	6726
HUSKY 34, 34D						0,6	BM6F	6221		
K65, L65, L77, R65						0,7	BPM6A	7021	BPMR6A	6726
RANCHER	40, 50, 61					0,7	BPM6A	7021	BPMR6A	6726

JONSEREDS JONSEREDS

625						0,7	BPM6A	7021	BPMR6A	6726
630	M					0,7	BPM6A	7021	BPMR6A	6726
820	M					0,6	BM6A	5921	BMR6A	7421
830						0,7	BPM7A	7321	BPMR7A	4626
920	M					0,6	BM6A	5921	BMR6A	7421
930						0,7	BPM7A	7321	BPMR7A	4626
111S, 451E, 451EV, 521EV, 621						0,7	BPM7A	7321	BPMR7A	4626
2041, 2050						0,7	BPM7A	7321	BPMR7A	4626

GARDEN EQUIPMENT



GARDEN EQUIPMENT • CHAINSAW



Model	Type	Capacity	Year	Cyl	Engine	Gap	Recommended	Stock Code	Alternative	Stock Code
-------	------	----------	------	-----	--------	-----	-------------	------------	-------------	------------

JONSEREDS						JONSEREDS				
2077						0,7	BPM6A	7021	BPMR6A	6726
2083TURBO, 2055TURBO						0,7	BPM7A	7321	BPMR7A	4626
2094						0,7	BPM6A	7021	BPMR6A	6726
45ES, 49SP, 66E, 66ES						0,7	BPM7A	7321	BPMR7A	4626
510SP, 520SP						0,7	BPM6F	5950		
70E, 90, 90E						0,7	BPM7A	7321	BPMR7A	4626
L1L-J						0,7	BM7A	6521	BMR7A	4226
M36						0,7	BM7A	6521	BMR7A	4226
M361, M361AV						0,7	BM7A	6521	BMR7A	4226
M451EV, 452, 495P						0,7	BPM7A	7321	BPMR7A	4626
M50, 52, 52E, 60, 62, 66						0,7	BPM7A	7321	BPMR7A	4626
M510						0,7	BPM6F	5950		
M70						0,7	BPM7A	7321	BPMR7A	4626
M75, 80, 90, 110, 111						0,7	BPM7A	7321	BPMR7A	4626
M801						0,7	BPM7A	7321	BPMR7A	4626
MK-70, MK-80, RS45						0,7	BPM7A	7321	BPMR7A	4626
R52E	BRUSH CUTTER					0,7	BPM7A	7321	BPMR7A	4626
RS51						0,7	BPM7A	7321	BPMR7A	4626
SUPER 3						0,7	BPM7A	7321	BPMR7A	4626
XF85, XG85						0,6	B6HS	4510	BR6HS	3922

KAMATSU ZENOAH						KAMATSU ZENOAH				
AYS	G380					0,7	BPM6A	7021	BPMR6A	6726
AYS	G620					0,7	BPM7A	7321	BPMR7A	4626

KIORITZ (ECHO)						KIORITZ (ECHO)				
CS-100						0,8	B7S	3710		
CS-100VL						0,7	BPM7A	7321	BPMR7A	4626
CS-200E						0,6	BM6A	5921	BMR6A	7421
CS-280EG						0,7	BMR6A	7421		
CS-280EVL						0,7	BMR6A	7421		
CS-285EVL						0,7	BMR6A	7421		
CS-290EVL						0,7	BMR6A	7421		
CS-300EVL						0,8	BPM6Y	4562		
CS-302						0,6	BM6A	5921	BMR6A	7421
CS-302S						0,6	BM6A	5921	BMR6A	7421
CS-304VL						0,6	BM6A	5921	BMR6A	7421
CS-30EVL						0,7	BMR6A	7421		
CS-315						0,6	BM6A	5921	BMR6A	7421
CS-320EVL						0,7	BMR6A	7421		
CS-330EVL						0,7	BMR6A	7421		
CS-332						0,7	BPMR7A	4626		
CS-332EV						0,7	BPM7A	7321	BPMR7A	4626
CS-351VL						0,7	BMR6A	7421		
CS-360EVL						0,7	BPM6A	7021	BPMR6A	6726
CS-4000, 4400						0,7	BPM7A	7321	BPMR7A	4626
CS-400EVL						0,7	BPM6A	7021	BPMR6A	6726
CS-440EVL						0,7	BPMR7A	4626		
CS-4500, 4500P						0,7	BPM7A	7321	BPMR7A	4626
CS-451VL, 452VL						0,7	BMR6A	7421		
CS-4600, CS-4601						0,7	BPM7A	7321	BPMR7A	4626
CS-500VL, 500EVL						0,7	BPMR6A	6726		
CS-510EVL, 550EVL						0,7	BPMR7A	4626		
CS-5500, CS-5501						0,7	BPM7A	7321	BPMR7A	4626
CS-602VL						0,7	BPM7A	7321	BPMR7A	4626
CS-60S						0,6	BM6A	5921	BMR6A	7421
CS-750VL						0,7	BPM7A	7321	BPMR7A	4626
CS-900EVL						0,7	BPM7A	7321	BPMR7A	4626
SC-750EVL						0,7	BPM7A	7321	BPMR7A	4626

KOHLER						KOHLER				
2.8	2.8 HP						BPR4FS-15	2727		



GARDEN EQUIPMENT • CHAINSAW



Model	Type	Capacity	Year	Cyl	Engine	Gap	Recommended	Stock Code	Alternative	Stock Code
MCCULLOCH						MCCULLOCH				
MINI MAC	6,6A					0,6	BM6F	6221		
MINI PRO	25					0,6	BM6F	6221		
MINI PRO	30					0,6	BM6F	6221		
MINI PRO	35					0,6	BM6F	6221		
P	10-10A					0,6	BM6F	6221		
P	10-10S					0,6	BM6F	6221		
PM	55					0,6	BM6F	6221		
PM	6					0,6	BM6F	6221		
POWER MAC	310					0,6	BM6F	6221		
POWER MAC	320					0,6	BM6F	6221		
POWER MAC	330					0,6	BM6F	6221		
POWER MAC	340					0,6	BM6F	6221		
PRO MAC	1010					0,6	BM6F	6221		
PRO MAC	555					0,6	BM6F	6221		
PRO MAC	800					0,6	BM6F	6221		
S10-10	A,E,L,LA					0,6	BM6F	6221		
SP	125					0,6	BM6F	6221		
SP	40					0,6	BM6F	6221		
SP	55					0,6	BM6F	6221		

OLEOMAC						OLEOMAC				
234	F					0,7	BPM6A	7021	BPMR6A	6726
240	F					0,7	BPM6A	7021	BPMR6A	6726
244	F					0,7	BPM6A	7021	BPMR6A	6726
251	B S					0,7	BPM6A	7021	BPMR6A	6726
252	F					0,7	BPM6A	7021	BPMR6A	6726
254	F					0,7	BPM6A	7021	BPMR6A	6726
261						0,7	BPM6A	7021	BPMR6A	6726
264	F,G					0,7	BPM6A	7021	BPMR6A	6726
272	MP					0,7	BPM6A	7021	BPMR6A	6726
284	G					0,7	BPM6A	7021	BPMR6A	6726
350	A, AF					0,7	BPM6A	7021	BPMR6A	6726
355	A, AF					0,7	BPM6A	7021	BPMR6A	6726
481	MP					0,7	BPM6A	7021	BPMR6A	6726
482	MP					0,7	BPM6A	7021	BPMR6A	6726
945	A, AF					0,7	BPM6A	7021	BPMR6A	6726
950	A					0,7	BPM6A	7021	BPMR6A	6726

PARTNER						PARTNER				
K	1200					0,7	BPM7A	7321	BPMR7A	4626
K	12S					0,7	BPM7A	7321	BPMR7A	4626
K	20					0,7	BM7A	6521	BMR7A	4226
K	40					0,7	BM7A	6521	BMR7A	4226
K650	DISC CUTTER					0,7	BM7A	6521	BMR7A	4226
MINI	P1					0,7	BM7A	6521	BMR7A	4226
MINI	P2					0,7	BM7A	6521	BMR7A	4226
MINI	P3					0,6	BM6F	6221		
MINI	PIV					0,6	BM6F	6221		
P	100					0,7	BPM7A	7321	BPMR7A	4626
P	100S					0,7	BPM7A	7321	BPMR7A	4626
P	500					0,7	BM7A	6521	BMR7A	4226
P	7000					0,7	BM7A	6521	BMR7A	4226

PIONEER						PIONEER				
20	P					0,7	BM7A	6521	BMR7A	4226
28	P					0,6	BM6A	5921	BMR6A	7421
38	P					0,7	BPM7A	7321	BPMR7A	4626
39	P					0,7	BPM7A	7321	BPMR7A	4626
41	P					0,6	BM6A	5921	BMR6A	7421
41S	P					0,6	BM6A	5921	BMR6A	7421
42	P					0,7	BPM7A	7321	BPMR7A	4626
42W	P					0,7	BPM7A	7321	BPMR7A	4626
50	P					0,7	BM7A	6521	BMR7A	4226
51	P					0,7	BPM7A	7321	BPMR7A	4626
52	P					0,7	BPM7A	7321	BPMR7A	4626
60	P					0,7	BPM6A	7021	BPMR6A	6726
61	P					0,7	BPM6A	7021	BPMR6A	6726
62	P					0,7	BPM7A	7321	BPMR7A	4626



GARDEN EQUIPMENT • CHAINSAW



Model	Type	Capacity	Year	Cyl	Engine	Gap	Recommended	Stock Code	Alternative	Stock Code
-------	------	----------	------	-----	--------	-----	-------------	------------	-------------	------------

SACHS - DOLMAR							SACHS - DOLMAR			
112						0,7	BPM6A	7021	BPMR6A	6726
113						0,7	BPM6A	7021	BPMR6A	6726
114						0,7	BPM7A	7321	BPMR7A	4626
115						0,7	BPM7A	7321	BPMR7A	4626
116	SI					0,7	BPM7A	7321	BPMR7A	4626
117						0,7	BPM7A	7321	BPMR7A	4626
120	SI					0,7	BPM7A	7321	BPMR7A	4626
123						0,7	BPM7A	7321	BPMR7A	4626
133	S					0,7	BPM7A	7321	BPMR7A	4626
143						0,7	BPM6A	7021	BPMR6A	6726
153						0,7	BPM7A	7321	BPMR7A	4626
166						0,7	BPM7A	7321	BPMR7A	4626

SOLO							SOLO			
600	B					0,7	BPM6A	7021	BPMR6A	6726
603	AV					0,7	BPM6A	7021	BPMR6A	6726
605	AV					0,7	BPM6A	7021	BPMR6A	6726
606	AV					0,7	BPM6A	7021	BPMR6A	6726
610	AV					0,7	BPM6A	7021	BPMR6A	6726
615	AV					0,7	BPM6A	7021	BPMR6A	6726
616	AV					0,7	BPM6A	7021	BPMR6A	6726
620	AV					0,7	BPM6A	7021	BPMR6A	6726
633						0,7	BPMR7A	4626		
635						0,7	BPMR7A	4626		
636						0,7	BPMR7A	4626		
640	C					0,7	BPM6A	7021	BPMR6A	6726
641						0,7	BPM6A	7021	BPMR6A	6726
644	VA					0,7	BPM6A	7021	BPMR6A	6726
644						0,7	BPM6A	7021	BPMR6A	6726
647	AV					0,7	BPM6A	7021	BPMR6A	6726
650	VA					0,7	BPM6A	7021	BPMR6A	6726
651						0,7	BPMR7A	4626		
654	AV					0,7	BPM6A	7021	BPMR6A	6726
655	VA					0,7	BPM6A	7021	BPMR6A	6726
660	VA					0,7	BPM6A	7021	BPMR6A	6726
667	AV					0,7	BPM6A	7021	BPMR6A	6726
680	AV					0,7	BPM6A	7021	BPMR6A	6726
694						0,7	BPMR7A	4626		
HOBBY	645					0,6	B6HS	4510	BR6HS	3922
TWIN 100						0,7	BM7A	6521	BMR7A	4226

STIHL							STIHL			
8	S					0,6	B6HS	4510	BR6HS	3922
009AV						0,7	BPMR7A	4626		
10	AV					0,7	BPM6A	7021	BPMR6A	6726
010AV						0,7	BPMR7A	4626		
11	AV					0,7	BPM7A	7321	BPMR7A	4626
011AV						0,7	BPMR7A	4626		
15	AV					0,7	BPM6A	7021	BPMR6A	6726
015AV						0,7	BPMR7A	4626		
17						0,7	BPMR7A	4626		
019T						0,7	BPMR7A	4626		
20	AV					0,7	BPM6A	7021	BPMR6A	6726
020AV						0,7	BPMR7A	4626		
023L						0,7	BPMR7A	4626		
24	AV					0,7	BPM7A	7321	BPMR7A	4626
024AV						0,7	BPMR7A	4626		
28	AV					0,7	BPM6A	7021	BPMR6A	6726
028AV						0,7	BPMR7A	4626		
30	AV					0,7	BPM6A	7021	BPMR6A	6726
31	AV					0,7	BPM6A	7021	BPMR6A	6726
32	AV,AVS					0,7	BPM7A	7321	BPMR7A	4626
34	AV,AVS					0,7	BPM7A	7321	BPMR7A	4626
38	AV,AVS					0,7	BPM7A	7321	BPMR7A	4626
40	AV					0,7	BPM6A	7021	BPMR6A	6726
41	AV					0,7	BPM6A	7021	BPMR6A	6726
42	AV					0,7	BPM6A	7021	BPMR6A	6726
044C						0,7	BPMR7A	4626		
45	AV					0,7	BPM6A	7021	BPMR6A	6726
48	AV					0,7	BPM7A	7321	BPMR7A	4626



GARDEN EQUIPMENT • CHAINSAW



Model	Type	Capacity	Year	Cyl	Engine	Gap	Recommended	Stock Code	Alternative	Stock Code
-------	------	----------	------	-----	--------	-----	-------------	------------	-------------	------------

STIHL										STIHL
51	AV					0,7	BPM7A	7321	BPMR7A	4626
56	ELECTRONIC					0,7	BPM7A	7321	BPMR7A	4626
64	ELECTRONIC					0,7	BPM7A	7321	BPMR7A	4626
06,07,07S,08						0,8	BP6HS	4511	BPR6HS	7022
70	AV					0,7	BPM6A	7021	BPMR6A	6726
75	AV					0,7	BPM6A	7021	BPMR6A	6726
84	ELECTRONIC					0,7	BPM7A	7321	BPMR7A	4626
08S						0,8	B6HS	4510	BR6HS	3922
90	AV					0,7	BPM6A	7021	BPMR6A	6726
90	N					0,7	BPM6A	7021	BPMR6A	6726
90	S					0,7	BPM6A	7021	BPMR6A	6726
1106-CONTRA	G,GS					0,7	BPM6A	7021	BPMR6A	6726
1108						0,7	BPM6A	7021	BPMR6A	6726
BG60E						0,7	BMR6A	7421		
FR350						0,7	BPMR7A	4626		
FR450						0,7	BPMR7A	4626		
FS120						0,7	BPMR7A	4626		
FS300						0,7	BPMR7A	4626		
FS350						0,7	BPMR7A	4626		
FS400						0,7	BPMR7A	4626		
FS450						0,7	BPMR7A	4626		
FS550						0,7	BPMR7A	4626		
FS75						0,7	BPMR7A	4626		
FS85						0,7	BPMR7A	4626		
MS	170					0,7	BPMR7A	4626		
TS350						0,6	BP6HS	4511	BPR6HS	7022
TS510						0,7	BPM7A	7321	BPMR7A	4626

GARDEN EQUIPMENT



GARDEN EQUIPMENT • LAWN MOWERS



Model	Type	Capacity	Year	Cyl	Engine	Gap	Recommended	Stock Code	Alternative	Stock Code
AGRIA										
200	B & S					0,6	B4LM	3410		
200	B & S					0,7	B7HS	5110	BR7HS	4122
400	QUICKLY					0,6	B4LM	3410		
1700	HIRTH					0,6	AB-6	2910		
1700	JLO					0,6	AB-6	2910		
1700	NSU					0,5	B4H	4110		
2300	HIRTH					0,6	AB-6	2910		
2300	JLO					0,5	AB-7	3010		
2300	NSU					0,5	B4H	4110		
2400	HIRTH					0,6	AB-6	2910		
2400	JLO 4.77					0,5	AB-7	3010		
2400	JLO 5.77					0,6	B6HS	4510	BR6HS	3922
2400	MAG					0,5	B4H	4110		
2400	NSU					0,5	B4H	4110		
3300	JLO					0,6	B6HS	4510	BR6HS	3922
3300	MAX					0,5	B4H	4110		
4000	S					0,6	AB-6	2910		
4700						0,5	B4H	4110		
5200						0,7	B6S	3510		
5900						0,6	BP6HS	4511	BPR6HS	7022
7900						0,6	BP6HS	4511	BPR6HS	7022
9300	PILOT					0,5	B5HS	4210		
9300	VOLKHYDRAULIK					0,5	B4H	4110		
BABY	14MM HEADS					0,5	B4H	4110		
BABY	18MM HEADS					0,6	AB-6	2910		
BABY	4000,S					0,6	AB-6	2910		
RECORD						0,6	AB-6	2910		
ARIENS										
B & S ENGINE	LM21 5 HP					0,6	B4LM	3410		
B & S ENGINE	LM21S 5.5 HP					0,6	B4LM	3410		
AS										
AS	4HP					0,6	B6HS	4510	BR6HS	3922
AS	7HP					0,6	B6HS	4510	BR6HS	3922
BRIGGS & STRATTON	5HP					0,6	B4LM	3410		
BRIGGS & STRATTON	8HP					0,6	B4LM	3410		
ROBIN	8HP EC17V					0,7	B7HS	5110	BR7HS	4122
ROBIN	EC10V					0,6	B4	3210		
ATCO										
BRIGGS & STRATTON						0,6	B4LM	3410		
ROBIN	EY14					0,6	B6HS	4510	BR6HS	3922
DENNIS										
KOHLER	12HP KL301					0,6	B6L	3212		
ESTATE MASTER										
BRIGGS & STRATTON	8HP					0,6	B4LM	3410		
ROBIN	6.5HP EC17V					0,5	B4H	4110		
ROBIN	8HP EC17V					0,7	B7HS	5110	BR7HS	4122
FLYMO										
BRIGGS & STRATTON						0,6	B4LM	3410		
ROBIN	EC10					0,6	B4	3210		
GRAVELY										
KOHLER	12HP K301					0,6	B6L	3212		
KOHLER	8HP K181					0,6	B4LM	3410		
HAY-HOE										
ASPERA	AV 500					0,6	B4LM	3410		
ASPERA	AV 520					0,6	B4LM	3410		
ASPERA	AV 600					0,6	B4LM	3410		



GARDEN EQUIPMENT • LAWN MOWERS



Model	Type	Capacity	Year	Cyl	Engine	Gap	Recommended	Stock Code	Alternative	Stock Code
HAY-HOE						HAY-HOE				
ASPERA	LAV 35					0,6	B4LM	3410		
BRIGGS & STRATTON						0,6	B4LM	3410		
KAWASAKI	KT 43					0,6	B6HS	4510	BR6HS	3922
ROBIN	EC10					0,6	B4	3210		
TECUMSEH	3.5HP					0,6	B4LM	3410		
HONDA						HONDA				
FORMULA 120	GXV120N2					0,8	BPR5ES	94084		
FORMULA 160	GXV160N5					0,8	BPR6ES	96989		
HR 17	1.7HP					0,6	BMR4A	5728		
HR 194	4HP GXV120					0,8	BPR6ES	96989		
HR 21	3.5HP GV150					0,6	BM6A	5921	BMR6A	7421
HR 21.5-PR,SXR	5HP GV200					0,6	BM6A	5921	BMR6A	7421
HRA 214-SXR	4HP GXV120					0,8	BPR6ES	96989		
IMPALA						IMPALA				
HONDA	10HP G400					0,5	B4H	4110		
ROBIN	EY45V					0,6	BM6A	5921	BMR6A	7421
KOHLER						KOHLER				
XT6,XT7						0,9	DPR5EA-9	2887		
KUDU						KUDU				
HONDA	10HP G400					0,5	B4H	4110		
KOHLER	12HP K301					0,6	B6L	3212		
KOHLER	8HP K181					0,6	B4LM	3410		
ROBIN	10HP EY40					0,6	B6HS	4510	BR6HS	3922
ROBIN	12HP EC25					0,6	B6HS	4510	BR6HS	3922
MIRACLE						MIRACLE				
ASPERA	AV 600					0,6	B4LM	3410		
ASPERA	LAV 35					0,6	B4LM	3410		
BRIGGS & STRATTON						0,6	B4LM	3410		
ROBIN	EC10V					0,6	B4	3210		
MORRISON						MORRISON				
BRIGGS & STRATTON	3.5HP					0,6	B4LM	3410		
BRIGGS & STRATTON	4HP					0,6	B4LM	3410		
BRIGGS & STRATTON	5HP					0,6	B4LM	3410		
BRIGGS & STRATTON	7HP					0,6	B4LM	3410		
BRIGGS & STRATTON	8HP					0,6	B4LM	3410		
HONDA	5HP GX140					0,8	BPR6ES	96989		
ROBIN	3.5HP EY15					0,6	B6HS	4510	BR6HS	3922
ROBIN	6.5HP EC17V					0,5	B4H	4110		
ROBIN	8HP EC17V					0,7	B7HS	5110	BR7HS	4122
ROBIN	EY20					0,6	B6HS	4510	BR6HS	3922
VILLIERS	3.5HP F15					0,5	B6ES	7310	BP6ES	91076
VILLIERS	5HP F17					0,6	B6HS	4510	BR6HS	3922
MOWMASTER						MOWMASTER				
BRIGGS & STRATTON	5HP					0,6	B4LM	3410		
KAWASAKI	KT 43					0,6	B6HS	4510	BR6HS	3922
PROFESSIONAL						PROFESSIONAL				
BRIGGS & STRATTON	3HP					0,6	B4LM	3410		
BRIGGS & STRATTON	3.5HP					0,6	B4LM	3410		
BRIGGS & STRATTON	4HP					0,6	B4LM	3410		
BRIGGS & STRATTON	5HP					0,6	B4LM	3410		
HONDA	3.5HP GV150					0,6	BM6A	5921	BMR6A	7421
HONDA	5HP G200					0,5	B4H	4110		
ROBIN	3.5HP EY15					0,6	B6HS	4510	BR6HS	3922
ROBIN	4HP EC10V					0,6	B4	3210		
ROBIN	5HP EY20					0,6	B6HS	4510	BR6HS	3922

GARDEN EQUIPMENT



GARDEN EQUIPMENT • LAWN MOWERS



Model	Type	Capacity	Year	Cyl	Engine	Gap	Recommended	Stock Code	Alternative	Stock Code
QUALCAST										
QUALCAST										
BRIGGS & STRATTON						0,6	B4LM	3410		
SUPER COLT						0,6	B4LM	3410		
SUPER PUNCH						0,6	B4LM	3410		
RANSOMES										
RANSOMES										
BRIGGS & STRATTON	5HP					0,6	B4LM	3410		
HONDA	5HP G200					0,5	B4H	4110		
MAG 1026 -SRL	10HP					0,5	B5HS	4210		
MAG 1026 -SRL	7,5HP					0,5	B5HS	4210		
ROBIN	3.5HP EY14					0,6	B6HS	4510	BR6HS	3922
ROBIN	3.5HP EY15					0,6	B6HS	4510	BR6HS	3922
ROBIN										
ROBIN										
EC10V				2 STROKE		0,6	B4	3210		
EC17V	6.5 HP			2 STROKE		0,5	B4H	4110		
EC17V	8HP			2 STROKE		0,7	B7HS	5110	BR7HS	4122
EY15V				4 STROKE		0,6	BMR4A	5728		
EY20V				4 STROKE		0,6	BMR4A	5728		
ROLUX										
ROLUX										
BRIGGS & STRATTON	2HP					0,6	B4LM	3410		
BRIGGS & STRATTON	3.5HP					0,6	B4LM	3410		
BRIGGS & STRATTON	5HP					0,6	B4LM	3410		
SCOTT BONNAR										
SCOTT BONNAR										
BRIGGS & STRATTON	3HP					0,6	B4LM	3410		
BRIGGS & STRATTON	5HP					0,6	B4LM	3410		
BRIGGS & STRATTON	8HP					0,6	B4LM	3410		
HONDA	10HP G400					0,5	B4H	4110		
HONDA	3HP GX110					0,8	BPR6ES	96989		
HONDA	3.5HP GV150					0,6	BM6A	5921	BMR6A	7421
HONDA	5HP GV200					0,6	BM6A	5921	BMR6A	7421
HONDA	5HP GX140					0,8	BPR6ES	96989		
HONDA	7HP G300					0,5	B4H	4110		
KAWASAKI	3.4HP KF 34					0,6	B4LM	3410		
KAWASAKI	5.3HP KF 53					0,6	B6HS	4510	BR6HS	3922
ROBIN	3.5HP EY15					0,6	B6HS	4510	BR6HS	3922
ROBIN	4HP EC10V					0,6	B4	3210		
ROBIN	5HP EY20V					0,6	B6HS	4510	BR6HS	3922
ROBIN	6.5HP EC17					0,5	B4H	4110		
ROBIN	8HP EC17V					0,7	B7HS	5110	BR7HS	4122
SISIS										
SISIS										
BRIGGS & STRATTON	3,5,8HP					0,6	B4LM	3410		
SOLO										
SOLO										
546R						0,7	BMR6A	7421		
546RS	TEC					0,7	B6S	3510		
550						0,7	BMR6A	7421		
550H						0,8	BPR5ES	94084		
550HR	HONDA					0,8	BPR5ES	94084		
550R						0,7	BMR6A	7421		
550RS	B & S					0,7	BMR6A	7421		
582	B & S					0,7	B2-LM	1147		
SOUTHERN CROSS										
SOUTHERN CROSS										
ASPERA	AV 600					0,6	B4LM	3410		
ASPERA	LAV 35					0,6	B4LM	3410		
SPRITE										
SPRITE										
BRIGGS & STRATTON						0,6	B4LM	3410		



GARDEN EQUIPMENT • LAWN MOWERS



Model	Type	Capacity	Year	Cyl	Engine	Gap	Recommended	Stock Code	Alternative	Stock Code
-------	------	----------	------	-----	--------	-----	-------------	------------	-------------	------------

STAG										
STAG										
STAG										
ROBIN	6.5HP EC17V					0,5	B4H	4110		
ROBIN	8HP EC17V					0,7	B7HS	5110	BR7HS	4122

STILETTO										
STILETTO										
ASPERA	3.5HP					0,6	B4LM	3410		
BRIGGS & STRATTON	4HP					0,6	B4LM	3410		
BRIGGS & STRATTON	5HP					0,6	B4LM	3410		
ROBIN	EC10V					0,6	B4	3210		
YAMAHA	4.3HP					0,6	B6HS	4510	BR6HS	3922

SUFFOLK										
SUFFOLK										
PONY				2-STROKE		0,5	B5HS	4210		
.				4-STROKE		0,6	B4LM	3410		

SUZUKI										
SUZUKI										
M120X						0,7	BPM6A	7021	BPMR6A	6726
S150						0,6	BP6HS	4511	BPR6HS	7022
S200						0,6	BP6HS	4511	BPR6HS	7022
V120						0,8	BPR6ES	96989		
V160						0,8	BPR6ES	96989		

TORO										
TORO										
BRIGGS & STRATTON						0,6	B4LM	3410		
TECUMSEH	3.5HP					0,6	B4LM	3410		

VICTA										
VICTA										
-	12MM REACH					0,5	B5HS	4210		
-	19MM REACH					0,6	B4ES	4129		
-	9.5MM REACH					0,6	B4LM	3410		

WARRIOR										
WARRIOR										
ASPERA	AV 520					0,6	B4LM	3410		
ASPERA	AV 600					0,6	B4LM	3410		
BRIGGS & STRATTON						0,6	B4LM	3410		
ROBIN	EC10V					0,6	B4	3210		

WEBB										
WEBB										
BRIGGS & STRATTON	2-3HP					0,6	B4LM	3410		

WOLF										
WOLF										
BRIGGS & STRATTON						0,6	B4LM	3410		
HONDA	GV150					0,6	BM6A	5921	BMR6A	7421

WOLSELEY										
WOLSELEY										
BRIGGS & STRATTON	10HP					0,6	B4LM	3410		

YAMAHA										
YAMAHA										
MT110VLS						0,7	B6HS	4510	BR6HS	3922

GARDEN EQUIPMENT



GARDEN EQUIPMENT • POWER PRUNER



Model	Type	Capacity	Year	Cyl	Engine	Gap	Recommended	Stock Code	Alternative	Stock Code
-------	------	----------	------	-----	--------	-----	-------------	------------	-------------	------------

HONDA								HONDA		
960S						0,8	BR6HSA	4296		



GARDEN EQUIPMENT • RIDE-ON MOWERS



Model	Type	Capacity	Year	Cyl	Engine	Gap	Recommended	Stock Code	Alternative	Stock Code
ARIENS										
BRIGGS & STRATTON	13 HP RM1328					0,7	B2-LM	1147		
BRIGGS & STRATTON OHV	15 HP 1540G					0,8	BKR5E	92870	BK5E	94946
CUSHMAN										
OMC	18HP					0,8	AP5FS	2610		
GILSON										
BRIGGS & STRATTON	11HP					0,6	B4LM	3410		
BRIGGS & STRATTON	8HP					0,6	B4LM	3410		
GRAVELY										
BRIGGS & STRATTON	16HP					0,6	B4LM	3410		
KOHLER	16HP K341					0,6	B6L	3212		
HONDA										
H30115E	8.2 KW					0,8	BPR6ES	96989		
H4013SE	9.7 KW					0,8	BPR5ES	94084		
HT 3810	10HP					0,7	BR4HS	3322		
HTR 3009	9.7 KW					0,8	BPR5ES	94084		
HTR 3813	6.3 KW					0,7	BP4HS	3611	BPR4HS	7823
HUSTLER										
KOHLER	23HP K582					0,6	B6L	3212		
JACOBSEN										
KOHLER	14HP K321					0,6	B6L	3212		
KOHLER	16HP K341					0,6	B6L	3212		
KOHLER	23HP K582					0,6	B6L	3212		
JOHN DEERE										
BRIGGS & STRATTON	8HP					0,6	B4LM	3410		
KOHLER	10HP K241					0,6	B6L	3212		
KOHLER	12HP K301					0,6	B6L	3212		
KOHLER	14HP K321					0,6	B6L	3212		
KOHLER	16HP K341					0,6	B6L	3212		
KOHLER	18HP K482					0,6	B6L	3212		
KOHLER	8HP K181					0,6	B4LM	3410		
MAC GARDA										
BRIGGS & STRATTON	10HP					0,6	B4LM	3410		
BRIGGS & STRATTON	8HP					0,6	B4LM	3410		
MIRAGE										
BRIGGS & STRATTON	11HP					0,6	B4LM	3410		
BRIGGS & STRATTON	8HP					0,6	B4LM	3410		
ROBIN	8HP EC17V					0,7	B7HS	5110	BR7HS	4122
ROBIN	EC10V					0,6	B4	3210		
NATIONAL										
BRIGGS & STRATTON	10HP					0,6	B4LM	3410		
BRIGGS & STRATTON	8HP					0,6	B4LM	3410		
ROLUX										
BRIGGS & STRATTON	11HP					0,6	B4LM	3410		
BRIGGS & STRATTON	8HP					0,6	B4LM	3410		
ROBIN	EC10V					0,6	B4	3210		
RYAN										
BRIGGS & STRATTON	7HP					0,6	B4LM	3410		
BRIGGS & STRATTON	8HP					0,6	B4LM	3410		
KOHLER	6.25HP K141					0,7	B6S	3510		



GARDEN EQUIPMENT • RIDE-ON MOWERS



Model	Type	Capacity	Year	Cyl	Engine	Gap	Recommended	Stock Code	Alternative	Stock Code
SACHS-DOLMAR						SACHS-DOLMAR				
BC	330					0,7	BPM6F	5950		
BC	400					0,7	BPM6A	7021	BPMR6A	6726
SCOTT BONNAR						SCOTT BONNAR				
BRIGGS & STRATTON	11HP					0,6	B4LM	3410		
SIMPLICITY						SIMPLICITY				
BRIGGS & STRATTON	8HP					0,6	B4LM	3410		
STILETTO						STILETTO				
BRIGGS & STRATTON	10HP					0,6	B4LM	3410		
BRIGGS & STRATTON	8HP					0,6	B4LM	3410		
TORO						TORO				
BRIGGS & STRATTON	11HP					0,6	B4LM	3410		
BRIGGS & STRATTON	5HP					0,6	B4LM	3410		
BRIGGS & STRATTON	8HP					0,6	B4LM	3410		
KOHLER	14HP K321					0,6	B6L	3212		
KOHLER	23HP K582					0,6	B6L	3212		
KOHLER	7HP K161					0,7	B6S	3510		
ONAN	20HP B 48G					0,6	BP5EFS	3712		
TECUMSEH	7HP					0,6	B4LM	3410		



COMMERCIAL & INDUSTRIAL ENGINES CONSTRUCTION MACHINE



Model	Type	Capacity	Year	Cyl	Engine	Gap	Recommended	Stock Code	Alternative	Stock Code
-------	------	----------	------	-----	--------	-----	-------------	------------	-------------	------------

KUBOTA							KUBOTA			
KD-15							Y-106-1	6525		
KH-1							Y-106-1	6525		
KH-10							Y-106-1	6525		
KH-11H							Y-106V	6926		
KH-12FD							Y-106V	6926		
KH-14							Y-106-1	6525		
KH-15							Y-106-1	6525		
KH-18							Y-106-1	6525		
KH-18-2							Y-103V	2031		
KH-20							Y-106V	6926		
KH-5H							Y-103V	2031		
KH-8							Y-103K	6325		
KH-8H-2							Y-103V	2031		
RC-15FD							Y-103K	6325		
RC-20							Y-103K	6325		
RC-20FD							Y-106V	6926		
RC-25							Y-103K	6325		
RC-8FD							Y-103K	6325		
RW-25							Y-106-1	6525		

WACKER							WACKER			
							0,7	BPR4HS	7823	

GARDEN EQUIPMENT

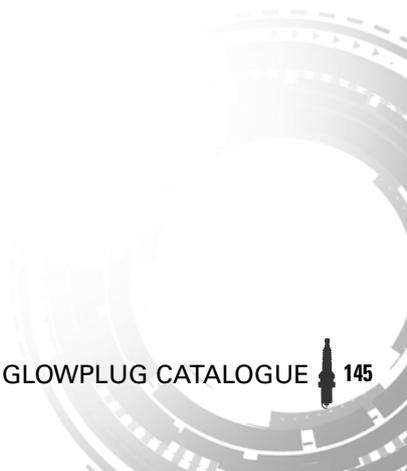



COMMERCIAL & INDUSTRIAL ENGINES FARM EQUIPMENT



Model	Type	Capacity	Year	Cyl	Engine	Gap	Recommended	Stock Code	Alternative	Stock Code
HONDA										
F 25						0,7	C6HSA	3228	CR6HSA	2983
F 28						0,7	C6HSA	3228	CR6HSA	2983
F 30						0,6	B6HS	4510	BR6HS	3922
F 40						0,6	B6HS	4510	BR6HS	3922
F 42						0,6	B6HS	4510	BR6HS	3922
F 250D,F						0,8	BPMR4A	6028		
F 300 (G150)						0,5	B4H	4110		
F 310						0,8	BPR5ES	94084		
F 360						0,8	BPR5ES	94084		
F 380						0,8	BPR5ES	94084		
F 600						0,6	B6HS	4510	BR6HS	3922
F 610D						0,8	BPR5ES	94084		
F 650						0,6	B6HS	4510	BR6HS	3922
F 700						0,6	B6HS	4510	BR6HS	3922

MITSUBISHI										
G3L						0,7	B6S	3510		
G4L						0,7	B6S	3510		
G4L-A						0,6	B4	3210		
G5L						0,7	B6S	3510		
G6L						0,6	B4	3210		
G6L						0,7	B6S	3510		
G7L						0,7	B6S	3510		
G7L-4						0,6	B4	3210		
G8L						0,7	B6S	3510		
N25						0,7	B6S	3510		



COMMERCIAL & INDUSTRIAL ENGINES

GASOLINE ENGINE



Model	Type	Capacity	Year	Cyl	Engine	Gap	Recommended	Stock Code	Alternative	Stock Code
LOMBARDINI						LOMBARDINI				
LA	205					0,5	B4H	4110		
LA	250					0,5	B4H	4110		
LA	400					0,5	B4H	4110		
LA	490					0,5	B4H	4110		
LAV	250					0,5	B4H	4110		
YANMAR						YANMAR				
GE25	GE25S					0,7	BP4HS	3611	BPR4HS	7823
GE36	S					0,5	B4H	4110		
GE50	S					0,5	B4H	4110		
GE70	S					0,5	B4H	4110		
GE90	S					0,5	B4H	4110		



COMMERCIAL & INDUSTRIAL ENGINES

GENERAL PURPOSE



Model	Type	Capacity	Year	Cyl	Engine	Gap	Recommended	Stock Code	Alternative	Stock Code
KUBOTA										KUBOTA
GH400						0,8	BPR4HS	7823		
GZ410						0,8	BKR5E	92870		
V2203-BBS							Y-716RS	4693		
WG750						1,1	BKR5E-11	93674		
Z400							Y-103V	2031		
Z400							Y-702R	1065		



COMMERCIAL & INDUSTRIAL ENGINES GENERATOR



Model	Type	Capacity	Year	Cyl	Engine	Gap	Recommended	Stock Code	Alternative	Stock Code
-------	------	----------	------	-----	--------	-----	-------------	------------	-------------	------------

HINOMOTO										HINOMOTO
E23			1955->1965	4			Y-805-1	5427		

HOMELITE										HOMELITE
H 400						0,7	BP5HS	4111		
H1250						0,8	BPR6ES	96989		
H2500						0,8	BPR6ES	96989		
H3500E						0,7	BP5HS	4111		

HONDA										HONDA
E1500 (G200)	CDI					0,7	BP4HS	3611	BPR4HS	7823
E1500 (G200)						0,5	B4H	4110		
E1500 (G42)						0,6	B6HS	4510	BR6HS	3922
E1500K4	CDI					0,7	BP4HS	3611	BPR4HS	7823
E1500K4						0,6	B6HS	4510	BR6HS	3922
E2000						0,6	B6HS	4510	BR6HS	3922
E2500						0,6	B6HS	4510	BR6HS	3922
E2500 (G300)	CDI					0,7	BP4HS	3611	BPR4HS	7823
E2500 (G300)						0,5	B4H	4110		
E3500 (G400)						0,5	B4H	4110		
E3700						1,1	BGP6E-11	1080	BCPR6E-11	96438
E3750						1,1	BGP6ES-11	7210	BCPR6ES-11	90010
E40						1,1	BGP5E-11	1099		
EB-X1800						0,8	BPR6ES	96989		
EB1600						0,5	B4H	4110		
EC1500 (G200)						0,5	B4H	4110		
EC1500 (G42)						0,6	B6HS	4510	BR6HS	3922
EC1500 (K4)						0,5	B4H	4110		
ED 300		1983->				0,7	BPM6A	7021	BPMR6A	6726
ED 300		1984->				0,8	BPMR4A	6028		
ED1000 (G42)						0,6	B6HS	4510	BR6HS	3922
EG 550						0,6	BM4A	5628	BMR4A	5728
EG 650						0,6	BM4A	5628	BMR4A	5728
EG1000X						0,8	BPR6ES	96989		
EG1400						0,8	BPR6ES	96989		
EG1400X						0,8	BPR6ES	96989		
EG1500						0,5	B4H	4110		
EG1500 (G200)						0,5	B4H	4110		
EG1500 (G42)						0,6	B6HS	4510	BR6HS	3922
EG1800						0,5	B4H	4110		
EG2200X/M						0,8	BPR6ES	96989		
EG3500X/M						0,8	BPR6ES	96989		
EM 650						0,7	BPMR4A	6028		
EM1400X						0,8	BPR6ES	96989		
EM2200X						0,8	BPR6ES	96989		
EM3500X,M						0,8	BPR5ES	94084		
EM4500						0,8	BPR6ES	96989		
EM4500SX						0,8	BPR6ES	96989		
EM5000						0,8	BPR6ES	96989		
EM5000SX,M,AO,A2						0,8	BPR6ES	96989		
EM650E						0,7	BMR4A	5728		
ES6500						0,6	BP6HS	4511	BPR6HS	7022
EV4000						0,6	BP6HS	4511	BPR6HS	7022
EW 170						0,5	B4H	4110		
EX 500						0,8	BPMR4A	6028		
EX 800						0,7	BP5HS	4111		
EX5500,K1,AO,A2						0,6	BP6HS	4511	BPR6HS	7022
GX 390,610,620						0,8	BPR6ES	96989		

KAWASAKI										KAWASAKI
GA	1000					0,7	BP4HS	3611	BPR4HS	7823
GA	1400					0,7	BP4HS	3611	BPR4HS	7823
GA	1800					0,7	BP4HS	3611	BPR4HS	7823
GA	550A			5		0,7	BMR6A	7421		
GC	550					0,6	BM6A	5921	BMR6A	7421
GE	4500					0,8	BPR5ES	94084		
KG	1100					0,7	B6S	3510		
KG	2300					0,7	BP4HS	3611	BPR4HS	7823
KG	3200					0,7	BP4HS	3611	BPR4HS	7823
KG	4000					0,6	B6HS	4510	BR6HS	3922



COMMERCIAL & INDUSTRIAL ENGINES GENERATOR



Model	Type	Capacity	Year	Cyl	Engine	Gap	Recommended	Stock Code	Alternative	Stock Code
KAWASAKI										
KG	5000		1983->			0,6	BM6A	5921	BMR6A	7421
KG	5000		1984->			0,5	B4H	4110		
KG	550					0,6	B6HS	4510	BR6HS	3922
KG	750					0,6	B6HS	4510	BR6HS	3922

KUBOTA										
A1000						0,7	BP4HS	3611	BPR4HS	7823
A1200						0,7	BP4HS	3611	BPR4HS	7823
A1400						0,7	BP4HS	3611	BPR4HS	7823
A1500						0,7	BP4HS	3611	BPR4HS	7823
A1800						0,7	BP4HS	3611	BPR4HS	7823
A2000						0,7	BP4HS	3611	BPR4HS	7823
A2100						0,7	BP4HS	3611	BPR4HS	7823
A2400						0,7	BP4HS	3611	BPR4HS	7823
A2500						0,7	BP4HS	3611	BPR4HS	7823
A3000						0,7	BP4HS	3611	BPR4HS	7823
A3050						0,7	BP4HS	3611	BPR4HS	7823
A350						0,6	BM4A	5628	BMR4A	5728
A3500						0,7	BP4HS	3611	BPR4HS	7823
A400						0,6	BM4A	5628	BMR4A	5728
A500						0,6	BM4A	5628	BMR4A	5728
A650						0,7	BP4HS	3611	BPR4HS	7823
A670						0,8	AP7FS	2127		
A800						0,7	BP4HS	3611	BPR4HS	7823
A800						0,7	BP4HS	3611	BPR4HS	7823
AE1100						0,7	BPR4HS	7823		
AE2200						0,7	BPR4HS	7823		
AE3200						0,7	BPR4HS	7823		
AE4500						0,7	BPR6HS	7022	BPR6HIX	4085
AE5500						0,8	BPR4HS	7823		
AV1600						0,7	BPR6HS	7022		
AV3800						0,7	BPR6HS	7022		
AV5500 6500						0,8	BPR4HS	7823		
AV650						0,7	BMR4A	5728		
NA1500						0,7	BPR4HS	7823		
NA1800						0,7	BPR4HS	7823		
NA1900						0,7	BPR4HS	7823		
NA2000						0,7	BPR4HS	7823		
NA2200						0,7	BPR4HS	7823		
NA2400						0,7	BPR4HS	7823		
NA2500						0,7	BPR4HS	7823		
NA2600						0,7	BPR4HS	7823		
NA3000						0,7	BPR4HS	7823		
NA3050						0,7	BPR4HS	7823		
NA3200						0,7	BPR4HS	7823		
NA3500						0,7	BPR4HS	7823		
NA400						0,7	BMR4A	5728		
NA500						0,7	BMR4A	5728		
NA510						0,7	BMR4A	5728		
NA600						0,7	BMR4A	5728		

MITSUBISHI										
K4					K4, KE150		Y-114T	6528		

SUZUKI										
SE 400,A						0,7	BPMR4A	6028		
SE 500,A,C						0,7	BPMR4A	6028		
SE 700A						0,7	BPM6A	7021	BPMR6A	6726
SE1000						0,6	BP6HS	4511	BPR6HS	7022
SE1200A,LA						0,6	BP6HS	4511	BPR6HS	7022
SE1500A						0,6	BP6HS	4511	BPR6HS	7022
SE1800A,LA						0,6	BP6HS	4511	BPR6HS	7022
SE2500A						0,6	BP6HS	4511	BPR6HS	7022
SE3000A						0,6	BP6HS	4511	BPR6HS	7022
SE4000S						0,6	BP6HS	4511	BPR6HS	7022
SE4000SE						0,6	BP6HS	4511	BPR6HS	7022
SW 140S						0,7	BP5HS	4111		
SX600,R						0,7	BP5HS	4111		

GARDEN EQUIPMENT



COMMERCIAL & INDUSTRIAL ENGINES GENERATOR



Model	Type	Capacity	Year	Cyl	Engine	Gap	Recommended	Stock Code	Alternative	Stock Code
YAMAHA						YAMAHA				
EF1000						0,6	BP6HS	4511	BPR6HS	7022
EF1400						0,6	BP6HS	4511	BPR6HS	7022
EF1400A						0,6	BP6HS	4511	BPR6HS	7022
EF1600						0,6	BP6HS	4511	BPR6HS	7022
EF1800						0,6	BP6HS	4511	BPR6HS	7022
EF2000A						0,6	BP6HS	4511	BPR6HS	7022
EF2500						0,6	BP6HS	4511	BPR6HS	7022
EF2600						0,6	BP6HS	4511	BPR6HS	7022
EF2800A						0,6	BP6HS	4511	BPR6HS	7022
EF3800						0,7	BPR6HS	7022		
EF5000	E					0,6	BP6HS	4511	BPR6HS	7022
EF5000DV	E					0,6	BP6HS	4511	BPR6HS	7022
EF600						0,7	BPM6A	7021	BPM6A	6726
EF6000						0,8	BPR5ES	94084		
ET1500			1980->			0,6	B6HS	4510	BR6HS	3922
ET1500			1981->			0,7	B7HS	5110	BR7HS	4122
ET500						0,6	B5ES	6410		
ET600	A					0,6	B5ES	6410		
ET900						0,6	B5ES	6410		
YL GENERATOR						0,8	BPR4ES	7222	GR4IX	7149
YL5000						0,7	BPR6HS	7022		
YANMAR						YANMAR				
MD 550						0,7	BPMR4A	6028		



COMMERCIAL & INDUSTRIAL ENGINES

INDUSTRIAL EQUIPMENT



Model	Type	Capacity	Year	Cyl	Engine	Gap	Recommended	Stock Code	Alternative	Stock Code
TOYOTA										TOYOTA
FORKLIFT		1998->	4	1DZ		Y-118-R	2187			



COMMERCIAL & INDUSTRIAL ENGINES

LAWN MOWER ENGINE



Model	Type	Capacity	Year	Cyl	Engine	Gap	Recommended	Stock Code	Alternative	Stock Code
-------	------	----------	------	-----	--------	-----	-------------	------------	-------------	------------

ROBIN

ROBIN					ROBIN					
EH30V					4 STROKE	0,8	BPR6ES	96989		
EH34V					4 STROKE	0,8	BPR6ES	96989		

SUZUKI

SUZUKI					SUZUKI					
M120X						0,7	BPM6A	7021	BPMR6A	6726
S150						0,6	BP6HS	4511	BPR6HS	7022
S200						0,6	BP6HS	4511	BPR6HS	7022
V120						0,8	BPR6ES	96989		
V160						0,8	BPR6ES	96989		

TECUMSEH

TECUMSEH					TECUMSEH					
BVS143DP					4 STROKE	0,7	B6S	3510		
MV100DP					2 STROKE	0,6	B4LM	3410		
OVXL120					4 STROKE	0,6	B6HS	4510	BR6HS	3922
TVM220					4 STROKE	0,7	B6S	3510		
TVS120					4 STROKE	0,7	B2-LM	1147		
TVXL195					4 STROKE	0,7	B6S	3510		
TVXL840					2 STROKE	0,7	BPM6A	7021	BPMR6A	6726

GARDEN EQUIPMENT



COMMERCIAL & INDUSTRIAL ENGINES

MULTI-PURPOSE ENGINE



Model	Type	Capacity	Year	Cyl	Engine	Gap	Recommended	Stock Code	Alternative	Stock Code
ACME										
A180 B,P	180			1		0,6	B6HS	4510	BR6HS	3922
A220 B,P	220			2		0,6	B6HS	4510	BR6HS	3922
AL 480	480			4		0,6	AB-6	2910		
AL 480W	14HP					0,6	AB-6	2910		
AL 550	550			5		0,6	AB-6	2910		
AL 550W	16HP					0,6	AB-6	2910		
ALN 215W	8HP					0,5	B5HS	4210		
ALN 290	290			2		0,6	B6HS	4510	BR6HS	3922
ALN 290W	8HP					0,5	B5HS	4210		
ALN 330	330			3		0,6	B6HS	4510	BR6HS	3922
ALN 330W,W	10HP					0,5	B5HS	4210		
AT 330	330			3		0,6	B6HS	4510	BR6HS	3922
FE 82W	12HP					0,6	AB-6	2910		
VT 88	16HP					0,5	B5HS	4210		
VT 88						0,6	B6HS	4510	BR6HS	3922
VT 94						0,6	B6HS	4510	BR6HS	3922
VT 94W	18HP					0,5	B5HS	4210		

ASPERA										
AV	125					0,6	B4LM	3410		
AV	520					0,6	B4LM	3410		
AV	600					0,6	B4LM	3410		
AV	750					0,7	B6S	3510		
BV	150					0,6	B4LM	3410		
BV	172					0,6	B4LM	3410		
BVR	150					0,6	B4LM	3410		
BVR	172					0,6	B4LM	3410		
BVR	175					0,6	B4LM	3410		
HBL	25					0,6	B4LM	3410		
HBL	30					0,6	B4LM	3410		
HBL	35					0,6	B4LM	3410		
HBL	40					0,6	B4LM	3410		
LAV	172					0,6	B4LM	3410		
LAV	30					0,6	B4LM	3410		
LAV	35					0,6	B4LM	3410		
LAV	40					0,6	B4LM	3410		
LAVR	30					0,6	B4LM	3410		
LAVR	35					0,6	B4LM	3410		
MV	100M					0,6	BM6A	5921	BMR6A	7421
MV	100S					0,6	B4LM	3410		
MV	125M					0,6	BM6A	5921	BMR6A	7421
MV	85M					0,6	BM6A	5921	BMR6A	7421
VM	100					0,6	B4LM	3410		
VM	70					0,6	B4LM	3410		
VM	80					0,6	B4LM	3410		

BRIGGS & STRATTON										
14MM CYL HEAD						0,6	B4LM	3410		
18MM CYL HEAD						0,6	AB-6	2910		

CLINTON										
100	V					0,6	B6L	3212		
190	VS					0,6	B6L	3212		
400	AVS					0,6	B6L	3212		
401	BVS					0,6	B6L	3212		
404						0,6	B6L	3212		
405						0,6	B6L	3212		
406						0,6	B6L	3212		
407						0,6	B6L	3212		
408						0,6	B6L	3212		
409						0,6	B6L	3212		
410						0,6	B6L	3212		
411						0,6	B6L	3212		
414						0,6	B6L	3212		
415						0,6	B6L	3212		
418	VS					0,6	B6L	3212		
419	VS					0,6	B6L	3212		
420	VS					0,6	B6L	3212		
422	VS					0,6	B6L	3212		

GARDEN EQUIPMENT



COMMERCIAL & INDUSTRIAL ENGINES

MULTI-PURPOSE ENGINE



Model	Type	Capacity	Year	Cyl	Engine	Gap	Recommended	Stock Code	Alternative	Stock Code
CLINTON										
426	VS					0,6	B6L	3212		
429	VS					0,6	B6L	3212		
431	VS					0,6	B6L	3212		
435						0,6	B6L	3212		
1600	A					0,6	B6L	3212		
1690						0,6	B6L	3212		
2100	A					0,6	B6L	3212		
2100	VS					0,6	B6L	3212		
2190	VS					0,6	B6L	3212		
2500	B					0,6	B6L	3212		
2590						0,6	B6L	3212		
2790						0,6	B6L	3212		
3100	V					0,6	B6L	3212		
3190						0,6	B6L	3212		
4100	VS					0,6	B6L	3212		
4190						0,6	B6L	3212		
EAGLE										
H 40	4HP					0,6	B4LM	3410		
H 50	5HP					0,6	B4LM	3410		
H 60	6HP					0,6	B4LM	3410		
H 80	8HP					0,6	B4LM	3410		
H 100	10HP					0,6	B4LM	3410		
H 120	12HP					0,6	B4LM	3410		
V 40	4HP					0,6	B4LM	3410		
V 50	5HP					0,6	B4LM	3410		
V 60	6HP					0,6	B4LM	3410		
V 80	8HP					0,6	B4LM	3410		
V 100	10HP					0,6	B4LM	3410		
V 120	12HP					0,6	B4LM	3410		
HOMELITE										
XLS2						0,6	BM6A	5921	BMR6A	7421
HONDA										
G 20						0,6	B6HS	4510	BR6HS	3922
G 25						0,7	C6HSA	3228	CR6HSA	2983
G 28						0,7	C6HSA	3228	CR6HSA	2983
G 30						0,6	B6HS	4510	BR6HS	3922
G 35						0,6	B6HS	4510	BR6HS	3922
G 40						0,6	B6HS	4510	BR6HS	3922
G 41						0,5	B4H	4110		
G 42						0,6	B6HS	4510	BR6HS	3922
G 45						0,6	B6HS	4510	BR6HS	3922
G 50						0,6	B6HS	4510	BR6HS	3922
G 65						0,6	B6HS	4510	BR6HS	3922
G 80						0,6	B6HS	4510	BR6HS	3922
G100	CDI					0,8	BPMR4A	6028		
G100						0,6	BM4A	5628	BMR4A	5728
G150						0,5	B4H	4110		
G200						0,5	B4H	4110		
G300						0,5	B4H	4110		
G400						0,5	B4H	4110		
GB 30						0,6	B6HS	4510	BR6HS	3922
GB 40						0,6	B6HS	4510	BR6HS	3922
GT 50						0,5	B4H	4110		
GT 65						0,5	B4H	4110		
GV 35						0,6	B6HS	4510	BR6HS	3922
GV100						0,7	BMR4A	5728		
GV150	K1					0,6	BM6A	5921	BMR6A	7421
GV150	SER.NO. 2029059					0,5	B4H	4110		
GV150	SER.NO. 2029060					0,6	BM6A	5921	BMR6A	7421
GV150N1B						0,7	BMR6A	7421		
GV200						0,7	BMR6A	7421		
GV400	CDI					0,7	BPM6A	7021	BPMR6A	6726
GV400						0,6	BM6A	5921	BMR6A	7421
GX110						0,8	BPR6ES	96989		
GX120						0,8	BPR6ES	96989		
GX140						0,8	BPR6ES	96989		



COMMERCIAL & INDUSTRIAL ENGINES

MULTI-PURPOSE ENGINE



Model	Type	Capacity	Year	Cyl	Engine	Gap	Recommended	Stock Code	Alternative	Stock Code
HONDA										
GX160						0,8	BPR6ES	96989		HONDA
GX240						0,8	BPR6ES	96989		
GX340						1,1	BP6ES-11	1212	BPR6ES-11	94967
GX360						0,7	BP4HS	3611	BPR4HS	7823
GXV120						0,8	BPR5ES	94084		
GXV160						0,8	BPR6ES	96989		
GXV270						0,8	BPR5ES	94084		
GXV340						0,8	BPR5ES	94084		

KAWASAKI										
FA	130					0,6	BM6A	5921	BMR6A	7421
FA	210					0,6	BM6A	5921	BMR6A	7421
FB	460V					0,6	BM4A	5628	BMR4A	5728
FC	150V					0,8	BPR6ES	96989		
FC	290V					0,8	BPR5ES	94084		
FG	100LB			1		0,7	BP4HS	3611	BPR4HS	7823
FG	150					0,7	BP4HS	3611	BPR4HS	7823
FG	150LB			1		0,7	BP4HS	3611	BPR4HS	7823
FG	200					0,7	BP4HS	3611	BPR4HS	7823
FG	200LB			2		0,7	BP4HS	3611	BPR4HS	7823
FG	300					0,7	BP4HS	3611	BPR4HS	7823
FG	300LB			3		0,7	BP4HS	3611	BPR4HS	7823
KF	100					0,5	B4H	4110		
KF	150					0,5	B4H	4110		
KF	200					0,5	B4H	4110		
KF	24					0,6	B6HS	4510	BR6HS	3922
KF	34					0,7	B6S	3510		
KF	82					0,6	B6HS	4510	BR6HS	3922
KT	40					0,6	B6HS	4510	BR6HS	3922
KT	43					0,6	B6HS	4510	BR6HS	3922
MULE 3000			2001->2006			0,8	BPR2ES	2264		
TD	40					0,7	BM7A	6521	BMR7A	4226

KOHLER										
K 90	4HP					0,7	B6S	3510		
K 91	4HP					0,7	B6S	3510		
K141	6.25HP					0,7	B6S	3510		
K181	8HP					0,7	B6S	3510		
K241	10HP					0,6	B6L	3212		
K301	12HP					0,6	B6L	3212		
K341	16HP					0,6	B6L	3212		
K582S	23HP					0,6	B6L	3212		
KT175	17HP					0,8	BP5FS	3412		
KT195	19HP					0,8	BP5FS	3412		
SV590						0,8	BK5E	94946	BKR5E	92870

KUBOTA										
A1200	GS130					0,7	BPR4HS	7823		
A1800	GN1850					0,8	BPR4HS	7823		
A2500	GN2500					0,8	BPR4HS	7823		
A3050	GS280					0,7	BPR4HS	7823		
A400	GN550					0,7	BMR4A	5728		
A800	GN130					0,7	BPR4HS	7823		
D1005-E							YE-01	2649		
D1105-E							YE-01	2649		
D662-E							YE-01	2649		
D722-E							YE-01	2649		
KH11,12,20	CONSTRUCTION MACHINE						Y-106V	6926		

MITSUBISHI										
L08						0,6	B4	3210		
L1L						0,6	B4	3210		
L2L						0,6	B4	3210		
L06P						0,6	B4	3210		
NE-35K						0,7	B6S	3510		



COMMERCIAL & INDUSTRIAL ENGINES

MULTI-PURPOSE ENGINE



Model	Type	Capacity	Year	Cyl	Engine	Gap	Recommended	Stock Code	Alternative	Stock Code
ONAN										
AJ						0,6	B6L	3212		ONAN
B	43G					0,6	BP5EFS	3712		
B	48G					0,6	BP5EFS	3712		
BH						0,6	B6L	3212		
CK						0,6	B6L	3212		
IB						0,6	AB-6	2910		
J120						0,6	B6L	3212		
J30						0,6	B6L	3212		
J60						0,6	B6L	3212		
JB						0,6	B6L	3212		
JC						0,6	B6L	3212		
MH						0,6	B6L	3212		
N-52M						0,6	BP5EFS	3712		
NB						0,6	B6L	3212		
NHA-MS						0,5	B6ES	7310		
NHB-MS						0,5	B6ES	7310		
NHC-MC			1979->			0,5	B6ES	7310		
NHC-MS			1979->			0,6	BP5EFS	3712		
NHP	LP-GAS					0,5	B6ES	7310		
OTC SERIES										
						0,7	B6S	3510		
RCCK-MS						0,6	B6L	3212		

ROBIN										
EC08					2 STROKE	0,7	B7HS	5110	BR7HS	4122
EC10					2 STROKE	0,6	B4	3210		
EC17	6.5HP				2 STROKE	0,5	B4H	4110		
EH30					4 STROKE	0,8	BPR6ES	96989		
EH34					4 STROKE	0,8	BPR6ES	96989		
EH43D					4 STROKE	0,8	BPR6ES	96989		
EY08					4 STROKE	0,6	BM4A	5628	BMR4A	5728
EY10					4 STROKE	0,6	B6HS	4510	BR6HS	3922
EY15					4 STROKE	0,6	B6HS	4510	BR6HS	3922
EY18					4 STROKE	0,6	B6HS	4510	BR6HS	3922
EY20					4 STROKE	0,6	B6HS	4510	BR6HS	3922
EY21					4 STROKE	0,6	B4	3210		
EY23					4 STROKE	0,6	B6HS	4510	BR6HS	3922
EY25					4 STROKE	0,6	B6HS	4510	BR6HS	3922
EY27					4 STROKE	0,6	B6HS	4510	BR6HS	3922
EY28					4 STROKE	0,6	B6HS	4510	BR6HS	3922
EY35	ELEC				4 STROKE	0,7	BP4HS	3611	BPR4HS	7823
EY35					4 STROKE	0,6	B6HS	4510	BR6HS	3922
EY40	ELEC				4 STROKE	0,7	BP4HS	3611	BPR4HS	7823
EY40					4 STROKE	0,6	B6HS	4510	BR6HS	3922
EY44					4 STROKE	0,6	B6HS	4510	BR6HS	3922
EY45V					4 STROKE	0,6	BM6A	5921	BMR6A	7421
EY80					4 STROKE	0,7	BP4HS	3611	BPR4HS	7823

TECUMSEH										
AH480	3.9HP					0,6	B4LM	3410		
AH520	2HP					0,6	B4LM	3410		
AH520	3HP					0,6	B4LM	3410		
AH817	5HP					0,6	B4LM	3410		
AV520	3HP					0,6	B4LM	3410		
AV600	5HP					0,6	B4LM	3410		
H50	5HP					0,6	B4LM	3410		
H80	8HP					0,6	B4LM	3410		
HM100Q					4 STROKE	0,7	B6S	3510		
HM80	8HP					0,6	B4LM	3410		
HM80Q					4 STROKE	0,7	B6S	3510		
HMSK70	6HP					0,6	B4LM	3410		
HMSK80	8HP					0,6	B4LM	3410		
HS40	4HP					0,6	B4LM	3410		
HS50	5HP					0,6	B4LM	3410		
HS50-1A	5HP					0,6	B4LM	3410		
HSK25	2.5HP					0,6	B4LM	3410		
HSK30	3HP					0,6	B4LM	3410		
HSK35	3,5HP					0,6	B4LM	3410		
HSSK40	4HP					0,6	B4LM	3410		
HSSK50	5HP					0,6	B4LM	3410		
LAV35	3,5HP					0,6	B4LM	3410		



COMMERCIAL & INDUSTRIAL ENGINES

MULTI-PURPOSE ENGINE



Model	Type	Capacity	Year	Cyl	Engine	Gap	Recommended	Stock Code	Alternative	Stock Code
TECUMSEH										
LAV35RM	3,5HP					0,6	B4LM	3410		
LAV40	4HP					0,6	B4LM	3410		
LAV40RM	4HP					0,6	B4LM	3410		
LAV50-1A	5HP					0,6	B4LM	3410		
LAV50RM	5HP					0,6	B4LM	3410		
OH120				4	4 STROKE	0,6	B6HS	4510	BR6HS	3922
OH120Q				4	4 STROKE	0,6	B6HS	4510	BR6HS	3922
OH160Q				4	4 STROKE	0,6	B6HS	4510	BR6HS	3922
OH160V				4	4 STROKE	0,6	B6HS	4510	BR6HS	3922
TVS840				2	2 STROKE	0,7	BPM6A	7021	BPMR6A	6726
V60	6HP					0,6	B4LM	3410		
V70	6HP					0,6	B4LM	3410		
V80	8HP					0,6	B4LM	3410		
VH100				4	4 STROKE	0,7	B6S	3510		
VH70	6HP					0,6	B4LM	3410		
VH80				4	4 STROKE	0,7	B6S	3510		
VM80	8HP					0,6	B4LM	3410		

VILLIERS										
10				4	4 STROKE	0,6	AB-6	2910		
1-OCT						0,5	B4H	4110		
12				4	4 STROKE	0,6	AB-6	2910		
1-DEC						0,5	B4H	4110		
2-DEC						0,5	B4H	4110		
20				4	4 STROKE	0,6	AB-6	2910		
25				4	4 STROKE	0,6	AB-6	2910		
40				4	4 STROKE	0,6	AB-6	2910		
507H-1						0,6	B6HS	4510	BR6HS	3922
512H	150					0,6	B6HS	4510	BR6HS	3922
515H	150					0,6	B6HS	4510	BR6HS	3922
515V	150					0,6	B6HS	4510	BR6HS	3922
7						0,5	B4H	4110		
C12						0,5	B4H	4110		
C30						0,5	B6ES	7310		
F12						0,5	B6ES	7310		
F15						0,5	B6ES	7310		
HIGH SPEED VERSIONS						0,6	AB-6	2910		
MARVIL						0,6	AB-6	2910		
MK.15						0,6	B6HS	4510	BR6HS	3922
MK.15HS						0,6	B6HS	4510	BR6HS	3922
MK.15/2						0,6	B6HS	4510	BR6HS	3922

WISCONSIN										
3						0,7	B6S	3510		
4						0,7	B6S	3510		
AC4						0,7	B6S	3510		
AC4S						0,6	B6L	3212		
ALL GASOLINE						0,6	AB-6	2910		
ALL MODELS LP-GAS						0,5	AB-7	3010		
EY	14W					0,6	B6HS	4510	BR6HS	3922
EY	18W					0,6	B6HS	4510	BR6HS	3922
EY	25W					0,6	B6HS	4510	BR6HS	3922
EY13						0,7	BP4HS	3611	BPR4HS	7823
EY18						0,7	BP4HS	3611	BPR4HS	7823
EY21W						0,7	B6S	3510		
EY25						0,7	BP4HS	3611	BPR4HS	7823
EY27W						0,6	B6HS	4510	BR6HS	3922
EY33						0,7	BP4HS	3611	BPR4HS	7823
EY44						0,7	BP4HS	3611	BPR4HS	7823
EY44W						0,6	B6HS	4510	BR6HS	3922
V	460,1,5,D					0,8	BPR5ES	94084		

YAMAHA										
MF150	A					0,6	BP6HS	4511	BPR6HS	7022
MF150	S					0,6	BP6HS	4511	BPR6HS	7022
MF180	A					0,6	BP6HS	4511	BPR6HS	7022
MF260	A					0,6	BP6HS	4511	BPR6HS	7022
MF410						0,6	BP6HS	4511	BPR6HS	7022
MT110VL	S					0,6	B6HS	4510	BR6HS	3922



COMMERCIAL & INDUSTRIAL ENGINES PUMP



Model	Type	Capacity	Year	Cyl	Engine	Gap	Recommended	Stock Code	Alternative	Stock Code
HOMELITE						HOMELITE				
AP215,150						0,8	BPR6ES	96989		
AP220,200						0,8	BPR6ES	96989		
DP3						0,8	BPR6ES	96989		
FP						0,6	BM6A	5921	BMR6A	7421
S1.5						0,8	BPR6ES	96989		
TP2						0,8	BPR6ES	96989		
TP3						0,7	BP5HS	4111		
XLS 1.5						0,6	BM6A	5921	BMR6A	7421
HONDA						HONDA				
W10						0,7	C6HSA	3228	CR6HSA	2983
W20						0,8	BPR6ES	96989		
W30						0,8	BPR6ES	96989		
WA10						0,6	BM4A	5628	BMR4A	5728
WA15						0,6	BM4A	5628	BMR4A	5728
WA20 (G150)						0,5	BP2ES	3467	BPR2ES	2264
WA20K1						0,5	B4H	4110		
WA20X						0,8	BPR6ES	96989		
WA30 (G200)						0,6	B6HS	4510	BR6HS	3922
WA30X						0,8	BPR6ES	96989		
WB10						0,8	BM4A	5628	BMR4A	5728
WB15						0,6	BM4A	5628	BMR4A	5728
WB20X						0,8	BPR6ES	96989		
WB30X						0,8	BPR6ES	96989		
WH20X						0,8	BPR6ES	96989		
W15						0,7	C6HSA	3228	CR6HSA	2983
WL20						0,7	C6HSA	3228	CR6HSA	2983
SUZUKI						SUZUKI				
SP20						0,6	BP6HS	4511	BPR6HS	7022
SP30						0,6	BP6HS	4511	BPR6HS	7022
SV1400,L						0,8	BPR6ES	96989		
SV1800,L						0,8	BPR6ES	96989		
SV2200,L						0,8	BPR6ES	96989		
V270						0,6	BP6HS	4511	BPR6HS	7022
VP20H						0,8	BPR6ES	96989		
VP30H						0,8	BPR6ES	96989		
YAMAHA						YAMAHA				
EP20						0,7	BPR6HS	7022		
YP10G						0,7	B7HS	5110	BR7HS	4122
YP12DJ	F					0,6	BP6HS	4511	BPR6HS	7022
YP12DJ	T					0,7	BP7HS	5111		
YP20G	N					0,7	BP4HS	3611	BPR4HS	7823
YP20G						0,7	B7HS	5110	BR7HS	4122
YP20N	T					0,6	B6HS	4510	BR6HS	3922
YP20T						0,6	BP6HS	4511	BPR6HS	7022
YP30	T					0,6	BP6HS	4511	BPR6HS	7022
YP30G	N					0,8	BPR5ES	94084		
YP30G						0,6	BP6HS	4511	BPR6HS	7022
YP30N	T					0,6	BP6HS	4511	BPR6HS	7022

GARDEN EQUIPMENT



GO KART



Model	Type	Capacity	Year	Cyl	Engine	Gap	Recommended	Stock Code	Alternative	Stock Code
ROTAX										
125	125 EVO	125	2015->	1		0,8	GR9DI-8	97430		ROTAX
125	125 MAX	125	2015->	1		0,8	GR8DI-8	94975		



GLOW PLUG CONVERSION CHART

BERU TO NGK



BERU



NGK

100101305	DG-237
100101306	DG-237
100220103	Y-207T
100220113	Y-204RS
100220114	Y-112M1
100220115	Y-112R1
100220118	Y-705RS
100220206	Y-403T
100221101	Y-302
100221102	Y-208T
100221103	Y-208T
100221105	Y-918J
100221106	Y-208T
100221107	Y-902R
100221125	Y-902R
100221132	Y-902R
100221133	Y-902R
100221135	Y-908R
100221141	Y-909R
100221144	Y-911R
100221145	Y-902R
100221146	Y-910R
100221147	Y-115T1
100221148	Y-128T
100221149	Y-117RS
100221151	Y-118T1
100221152	Y-204TS1
100221154	Y-107R
100221163	Y-917U
100221170	Y-739R
100221186	Y-306R
100221206	Y-404
100221209	Y-403-1
100221210	Y-405
100221301	Y-811
100221698	Y-935U
100222101	Y-118R
100222102	Y-168R
100222106	Y-508J
100222301	Y-403-1
100222301	Y-810
100222302	Y-810
100226129	Y-729U
100226163	Y-913M
100226164	Y-933J



BERU



NGK

100226170	Y-712RS
100226171	Y-712RS
100226173	Y-918R
100226180	Y-146R
100226182	Y-147T
100226183	Y-115R1
100226184	Y-730U
100226185	Y-922R
100226186	Y-923U
100226188	Y-731U
100226189	Y-914U
100226194	Y-707RS
100226198	Y-910J
100226206	Y-604J
100226207	Y-710J
100226208	Y-711J
100226209	Y-307R
100226227	Y-732U
100226229	Y-924U
100226233	Y-722JS
100226234	Y-916R
100226235	Y-925R
100226237	Y-933J
100226238	Y-740U
100226239	Y-516J
100226242	Y-703R
100226243	Y-715R
100226245	Y-506J
100226246	Y-738U
100226249	Y-928U
100226250	Y-929U
100226255	Y-605J
100226258	Y-930U
100226299	Y-927J
100226300	Y-748U
100226302	CZ261
100226312	Y1038J
100226336	Y-701J
100226338	Y-501U
100226343	Y-741U
100226344	Y-504J
100226351	Y-517J
100226352	Y-530J
100226354	Y-502R
100226362	Y-507J



BERU



NGK

100226365	Y-746J
100226366	Y-924J
100226371	Y-503J
100226372	Y-747U
100226373	Y-732J
100226375	Y-516J
100226379	Y-745U
100226381	Y-937J
100226384	Y-524J
100226385	Y-525J
100226391	Y-939J
100226392	Y-543J
100226417	Y-523J
100226422	Y-749J
100226432	Y-926U
100226434	Y-547AS
100226434	Y1031J
100226436	Y-534J
100226464	Y1031J
100226473	Y-745U
100226475	Y-532J
100226480	Y-542J
100226482	Y-741U
100226489	Y-523J
100226492	Y-1005J
100226495	Y-603J
100226496	Y-536J
100226497	Y-541J
100226504	Y-732J
100226510	Y-517J
100226511	Y-733J
100226513	CZ260
100226514	CZ260
100226517	Y-536J
100226520	Y-904M1
100226522	Y-527J
100226526	Y-529J
100226527	Y-531J
100226538	Y1012J
100226568	Y1013J
100226577	Y1001J1
100226639	Y1030J
100230101	Y-181T
100230102	Y-162R1
100230107	Y-755RS



BERU



NGK

100231104	Y-157R
100231107	Y-197R
100231109	Y-757RS
100231114	Y-197T
100266002	Y-547AS
100266003	Y1036AS
100266004	Y-1003AS
100266008	Y-607AS
100266009	YE14
100266011	Y-8002AS
100266016	Y-609AS
100266031	Y9004AS
100266032	Y1035AS
100266034	Y9003AS
100266037	Y1039AS
100266040	Y-1002AS
100266044	YE14
100266068	Y8001AS
100266075	Y1010AS
100266075	Y1010AS
100266079	Y8010AS
100266242	Y-703R
100276003	Y8005J
100276004	YE04
100276005	YE12
100276008	Y-8003J
100276012	YE05
100276014	YE13
100276015	YE07
100276024	YE08
100800031	Y-519J
100800035	CZ258
106671108	CZ104
1006226255	Y-605J
105MJ	Y-403-1
105MN	Y-208T
106MJ	Y-403-1
107M	Y-810
107MJ	Y-810
108MJ	Y-810
112M	Y-302
130MJ	Y-405
137MJ	Y-403T
141MJ	Y-207T
151MJ	Y-208T



GLOW PLUG CONVERSION CHART

BERU TO NGK



Beru NGK

155MJ	Y-404
161MJ	Y-208T
162MJ	Y-207T
162MJ	Y-207T
170MJ	Y-811
171MJ	Y-810
2510029123	Y-606J
2510029129	CZ251
601MJ	Y-918R
602MJ	Y-208T
603MJ	Y-924J
609MJ	Y-902R
613MJ	Y-902R
624MJ	Y-902R
631MJ	Y-907R
633MJ	Y-902R
636MJ	Y-924J
642MJ	Y-924J
657MJ	Y-909R
661MJ	Y-910J
663MJ	Y-924J
666MJ	Y-910J
673MJ	Y-115T1
678MJ	Y-128T
685MJ	Y-117RS
689MJ	Y-204TS1
705MJ	Y-107R
719MJ	Y-924J
730MJ	Y-739R
749MJ	Y-306R
783MJ	Y-729U
844MJ	Y-933J
852MJ	Y-913J
853MJ	Y-712RS
854MJ	Y-712RS
855MJ	Y-732J
857MJ	Y-918J
858MJ	Y-916J
860MJ	Y-930U
880MJ	Y-157R
886MJ	Y-146R
887MJ	Y-181T
888MJ	Y-204RS
889MJ	Y-112M1
890MJ	Y-162R1



Beru NGK

892MJ	Y-112R1
894MJ	Y-118R
895MJ	Y-197R
896MJ	Y-168R
897MJ	Y-147T
898MJ	Y-115R1
905MJ	Y-730U
908MJ	Y-924J
909MJ	Y-924J
912MJ	Y-503J
917MJ	Y-924J
920MJ	Y-705RS
921MJ	Y-707RS
922MJ	Y-757RS
927MJ	Y-910J
944MJ	Y-604J
945MJ	Y-307R
946MJ	Y-710J
947MJ	Y-711J
948MJ	Y-925J
950MJ	Y-732U
954MJ	Y-924J
959MJ	Y-933J
961MJ	Y-929U
963MJ	Y-506J
964MJ	Y-738U
968MJ	Y-715R
969MJ	Y-197T
970MJ	Y-928U
991MJ	Y-927J
999MJ	Y-740U
CGP002	CZ104
G 2	Y-902R
G 3	Y-902R
G 4	Y-907R
GD348	DG-237
GD368	DG-237
GD382	DG-237
GE100	Y-607AS
GE101	YE14
GE102	Y-547AS
GE105	Y-8002AS
GE108	Y-609AS
GE110	Y1035AS
GE111	Y1036AS



Beru NGK

GE112	Y9004AS
GE114	Y9003AS
GE115	Y-1002AS
GE118	Y1039AS
GE121	Y8001AS
GE121A	Y8001AS
GE122	Y1045AS
GE122	Y1045AS
GE124	Y-1010AS
GE124	Y1010AS
GE127	Y8010AS
GN003	Y-745U
GN005	Y-701J
GN007	Y-741U
GN008	Y-501U
GN010	Y-746R
GN012	Y-502R
GN013	Y-938R
GN015	Y-534J
GN016	Y-503R
GN017	Y-747U
GN018	Y-515J
GN019	Y-516J
GN022	Y-937R
GN024	Y-507R
GN026	Y-517J
GN027	Y-504R
GN030	Y-939J
GN033	Y-523J
GN035	Y-749J
GN039	Y-530J
GN041	Y-534J
GN042	Y-542J
GN043	Y-532J
GN044	Y-755RS
GN045	YE12
GN046	Y-741U
GN047	YE04
GN053	Y8003J
GN054	Y1005J
GN055	Y1031J
GN056	YE05
GN057	Y-508J
GN058	YE13
GN059	YE07



Bosch NGK

GN060	Y-536J
GN061	Y-904M1
GN062	Y-527J
GN063	YE08
GN064	Y-529J
GN065	Y-531J
GN072	CZ258
GN095	Y1001J1
GN097	Y1030J
GN101	CZ259
GN102	CZ260
GN103	Y-603J
GN104	Y-541J
GN107	Y-733J
GN108	Y1012J
GN109	Y-519J
GN110	Y1013J
GN110	Y1013J
GN116	Y-606J
GN121	CZ251
GN123	CZ267
GN853	Y-712RS
GN854	Y-712RS
GN855	Y-732U
GN857	Y-918R
GN858	Y-916R
GN860	Y-930U
GN905	Y-730U
GN908	Y-922R
GN909	Y-923U
GN912	Y-731U
GN917	Y-914U
GN921	Y-722J
GN925	Y-926U
GN927	Y-935U
GN939	Y-525J
GN944	Y-604J
GN948	Y-925R
GN954	Y-924U
GN955	Y-722JS
GN959	Y-932R
GN961	Y-929U
GN963	Y-506R
GN964	Y-738U
GN970	Y-928U



GLOW PLUG CONVERSION CHART

BERU TO NGK



Beru

NGK

GN985	Y-605J
GN991	Y-927R
GN992	Y-748U
GN993	Y-524J
GN994	CZ261
GN997	Y1038J
GN999	Y-740U
GV105	Y-208T
GV106	Y-403-1
GV107	Y-810
GV108	Y-810
GV112	Y-302
GV130	Y-405
GV137	Y-403T
GV151	Y-208T
GV155	Y-404
GV170	Y-811
GV602	Y-208T
GV603	Y-902R
GV624	Y-902R
GV631	Y-907R
GV636	Y-902R
GV642	Y-908R
GV657	Y-909R
GV661	Y-911R
GV663	Y-920R
GV666	Y-910R
GV673	Y-115T1
GV678	Y-128T
GV685	Y-117RS
GV688	Y-118T1
GV689	Y-204TS1
GV705	Y-107R
GV719	Y-917U
GV730	Y-739R
GV749	Y-306R
GV783	Y-729U
GV844	Y-933R
GV852	Y-913M
GV880	Y-157R
GV886	Y-146R
GV887	Y-181T
GV888	Y-204RS
GV889	Y-112M1
GV890	Y-162R1



Beru

NGK

GV892	Y-112R1
GV894	Y-118R
GV895	Y-197R
GV896	Y-168R
GV897	Y-147T
GV898	Y-115R1
GV920	Y-705RS
GV921	Y-707RS
GV922	Y-757RS
GV945	Y-307R
GV946	Y-742U
GV947	Y-711J
GV968	Y-715R
GV969	Y-197T
250001008	DG-237
250001010	DG-237
250001012	DG-237
250001016	DG-237
250001416	DG-237
250200013	Y-811
250200014	Y-810
250200020	Y-810
250200035	Y-302
250200037	Y-404
250200046	Y-403-1
250200048	Y-405
250200049	Y-207T
250200051	Y-403T
250200052	Y-207T
250200053	Y-909R
250200054	Y-208T
250200055	Y-810
250200056	Y-208T
250200058	Y-208T
250200059	Y-208T
250200060	Y-208T
250200063	Y-207T
250200065	Y-208T
250200068	Y-208T
250200069	Y-924J
250200420	Y-810
250200451	Y-403T
250200451	Y-403T
250200454	Y-208T
250200456	Y-208T



Beru

NGK

250200465	Y-208T
250200468	Y-208T
250201001	Y-902R
250201004	Y-918R
250201005	Y-902R
250201006	Y-908R
250201008	Y-902R
250201009	Y-902R
250201011	Y-918R
250201012	Y-909R
250201013	Y-902R
250201015	Y-918R
250201017	Y-907R
250201019	Y-902R
250201021	Y-918R
250201026	Y-916R
250201027	Y-917U
250201029	Y-913M
250201032	Y-918R
250201033	Y-923U
250201034	Y-909R
250201035	Y-930U
250201038	Y-925R
250201039	Y-902R
250201041	Y-916R
250201042	Y-924J
250201043	Y-913M
250201049	Y-937R
250201050	Y-932R
250201053	Y-939J
250201054	Y-925J
250201055	Y-916J
250201405	Y-902R
250201415	Y-918R
250202001	Y-907R
250202002	Y-739R
250202003	Y-115T1
250202004	Y-128T
250202005	Y-117RS
250202006	Y-118T1
250202007	Y-107T
250202008	Y-306R
250202009	Y-732U
250202013	Y-204RS
250202015	Y-103



Beru

NGK

250202017	Y-112R1
250202018	Y-910R
250202020	Y-731U
250202022	Y-732U
250202023	Y-741U
250202024	Y-927R
250202025	Y-730U
250202026	Y-929U
250202027	Y-604J
250202028	Y-504R
250202029	Y-745U
250202030	Y-543J
250202032	Y-504R
250202033	Y-935U
250202034	Y-928U
250202035	Y-506R
250202036	Y-534J
250202038	Y-1031J
250202039	Y-745U
250202040	Y-729U
250202041	Y-746R
250202042	Y-748U
250202043	Y-523J
250202045	Y-745U
250202048	Y-1005J
250202051	Y-146R
250202054	Y-118R
250202058	Y-147T
250202064	Y-755RS
250202065	Y-904M1
250202069	Y-112M1
250202071	Y-181T
250202076	Y-197R
250202077	Y-705RS
250202085	Y-742U
250202086	Y-306R
250202087	Y-711J
250202089	Y-701J
250202089	Y-701J
250202090	Y-1006J
250202092	Y-733J
250202093	Y-712RS
250202094	Y-733J
250202095	Y-532J
250202096	Y-715R



GLOW PLUG CONVERSION CHART

BERU TO NGK



Beru	NGK
250202097	Y-197T
250202102	Y-501U
250202103	Y-507R
250202107	Y-157R
250202110	Y-112T
250202119	Y-178T
250202124	Y-1007J
250202125	Y-531J
250202128	Y-517J
250202129	Y-516J
250202131	Y-524J
250202132	Y1030J
250202135	Y-1005J
250202136	Y-904M1
250202140	Y-929U
250202141	Y-745U
250202142	Y-745U
250202143	Y-605J
250202254	Y-1037J
250203001	YE07
250203002	Y-8003J
250203004	YE12
250203009	Y8005J
250203012	YE08
250203018	Y1045AS
250203018	Y1045AS
250204001	YE04
250204002	YE05
250212006	Y-749J
250212009	Y-732J
250212011	Y-527J
250212013	Y-507J
250302004	Y-1031J
250312001	CZ259
250312002	CZ260
250312003	Y603J
250312007	CZ257
250402001	Y607AS
250402002	Y-547AS
250402005	Y-607AS
250403001	Y8008AS
250403002	YE14
250403004	Y8011AS
250403007	Y1002AS
250403008	Y8002AS
250403009	Y1002AS

Beru	NGK
250403010	Y8009AS
250403011	Y9003AS
250403012	Y1035AS
250403013	Y1036AS
250403014	Y9001AS
250403019	Y8010AS
250403021	Y-1010AS
250403021	Y1010AS
250404001	Y8001AS
250523004	CZ251
2650203004	YE12
F002G50031	Y-8003J
F01G00000P	Y1012J
F01G004031	CZ267
GLP001	Y-924J
GLP002	Y-918J
GLP003	Y-732J
GLP004	Y-503J
GLP006	Y-916J
GLP007	Y-534J
GLP165	Y-904M1
GLP201	Y8011AS
GLP237	Y1010AS
GLP252	CZ251
GLP253	Y8010AS
GLP2HS	Y8011AS

Brisk	NGK
21N21	Y-208T
21N22	Y-208T
21N51	Y909R
21R01	Y-918J
21R02	Y-907R
21R06	Y-918J
21R21	Y-924J
21R22	Y-924J
21R23	Y-924J
21R26	Y-913J
21R51	Y-909R

Champion	NGK
AG32	Y-302
AG44	Y-811
CH101	Y-115R1
CH102	Y-112M1
CH103	Y-118T1
CH104	Y-197R
CH105	Y-204SS
CH110	Y-104R
CH121	Y-118T1
CH132	Y-118R
CH137	Y-908R
CH144	Y-110
CH147	Y-910R
CH154	Y-715R
CH158	Y-711J
CH159	Y-917U
CH160	Y-918R
CH161	Y-755RS
CH162	Y-707RS
CH163	Y-405
CH163 / 204	Y-923U
CH166	Y-747U
CH167 / 302	Y-928U
CH169	Y-730U
CH170	Y-504R
CH171	Y-732U
CH172	Y-740U
CH173	Y-913M
CH174	Y-914U
CH175	Y-930U
CH176	Y-916R
CH177	Y-925R
CH178	Y-729U
CH179	Y-932R
CH180	Y-745U
CH181	Y-741U
CH184	Y-515J
CH185	Y-503R
CH189	Y-938R
CH196	Y-524J
CH203	Y-507R
CH204	Y-929U
CH205 / 196	Y-937R
CH206	Y-927R
CH207	Y-748U
CH208	Y-738U



GLOW PLUG CONVERSION CHART

DENSO TO NGK





Champion	NGK
CH209	Y-939J
CH215	Y-501U
CH216	Y-502R
CH217	Y-506R
CH218	Y-745U
CH219	Y-746R
CH221	Y-115T1
CH222	Y-534J
CH223	Y-8003J
CH224	YE07
CH263	Y-1007J
CH268	Y-1005J
CH271	Y-732J
CH32	Y-302
CH44	Y-811
CH60	Y-207T
CH600	CY52
CH601	CY53
CH602	CY57
CH607	CZ256
CH61	DG-237
CH62	Y-207T
CH63	Y-208T
CH64	Y-404
CH65	Y-810
CH66	Y-403T
CH68	Y-902R
CH68 / 002	Y-523J
CH69	Y-901R
CH70	Y-909R
CH701	Y-547AS
CH702	YE14
CH725	Y1045AS
CH725	Y1045AS
CH78	Y-208T
CH79	Y-907R
CH87	Y-208T
CH88	Y-902R
CH90	Y-739R
CH94	Y-115T1
CH95	Y-146R
CH95 / 302	Y-703R
CH96	Y-204RS
CH97	Y-107R
CH98	Y-117RS





Daihatsu	NGK
CH99	Y-117SS





Denso	NGK
067100-0160	DG-211
067100-1042	Y-402-2
067100-1043	Y-452-1
067100-1070	Y-176
067100-1071	Y-176
067100-1090	Y-108
067100-1120	Y-178
067100-1130	Y-128
067100-1161	Y-178T
067100-1170	Y-128T
067100-1171	Y-128T
067100-1270	Y-118T1
067100-1330	Y-147T
067100-1340	Y-197T
067100-1350	Y-128T
067100-1360	Y-178T
067100-1370	Y-118R
067100-1380	Y-168R
067100-1430	Y-146R
067100-1460	Y-197R
067100-1530	Y-146R
067100-1630	Y-118T1
067100-1690	Y-703R
067100-1710	Y-715R
067100-1860	Y-532J
DG-176	Y-745U
DG001	Y-924J
DG002	Y-918R
DG003	Y-731U
DG004	Y-910R
DG005	Y-732U
DG006	Y-913M
DG007	Y-937R
DG008	Y-506R
DG009	Y-927R
DG010	Y-916R
DG012	Y-918J
DG101	Y-740U
DG102	Y-928U
DG103	Y-932R
DG104	Y-711RS
DG105	Y-115T1
DG106	Y-925R
DG108	Y-904M1
DG109	Y-741U





Denso	NGK
DG110	Y-929U
DG111	Y-502R
DG112	Y-516J
DG113	YE04
DG114	Y-107R
DG115	Y-729U
DG116	Y-504R
DG117	Y-925U
DG118	Y-748U
DG119	Y-930U
DG120	Y-707RS
DG121	Y-524J
DG123	Y-907R
DG124	Y-710R
DG126	Y-517J
DG127	Y-747U
DG130	Y-548J
DG133	Y-604J
DG137	Y-712RS
DG140	YE12
DG142	Y-523J
DG143	Y104R
DG144	Y-732U
DG145	Y-507R
DG146	Y-701J
DG155	Y-746R
DG157	Y-705RS
DG159	Y-307R
DG161	Y-923U
DG170	YE07
DG171	Y-8003J
DG172	Y-722JS
DG173	Y-749J
DG176	Y1031J
DG177	Y-607AS
DG178	Y-547AS
DG180	YE05
DG181	Y1005J
DG182	Y-605J
DG184	Y-543J
DG185	Y-605J
DG186	Y1038J
DG187	Y1007J
DG188	Y-536J
DG189	Y-508J



GLOW PLUG CONVERSION CHART

DENSO TO NGK



Denso	NGK
DG190	YE14
DG193	Y1002AS
DG194	Y8002AS
DG195	Y8005J
DG196	Y1030J
DG197	Y-519J
DG202	Y-909R
DG211	Y-715R
DG214	Y-532J
DG215	Y-118R
DG216	Y-703R
DG217	Y-531J
DG221	Y-118T1
DG222	Y-197R
DG223	Y-146R
DG226	Y-178
DG227	Y-128
DG232	Y-147T
DG233	Y-197T
DG234	Y-128T
DG235	Y-178T
DG239	Y-168R
DG240	Y-542J
DG245	Y-531J
DG300	CY53
DG301	CY57
DG302	CZ22
DG304	CY52
DG305	Y1013J
DG306	CZ256
DG307	CZ259
DG502	Y-529J
DG611	Y1045AS
DG615	Y-606J
DG633	Y8011AS

Fiat Grp	NGK
DG662	CZ251

HKT	NGK
B110	Y-749J
B120	Y-508J
CP01	CY51
CP02	CY52
CP03	CY08
CP05	CZ256
CP07	CY07
CP22	Y-1013J
CP50	Y-603J
CP51	CZ22
CP60	Y-107R
CP70	CZ-01
CP73	CZ258
CP73	Y-538J
PD190	Y-146R
PD191	Y-703R
PD99	Y-108
PH20	Y-173
PH21	Y-176
PH26	Y-173
PI12	DG-200A-1
PI13	DG-205
PI173	Y-784M
PI40	Y-874-1
PI41	Y-808-1
PI42	Y-104
PI43	Y-154
PI44	Y-271-2
PI45	Y-306R
PI46	Y-104R
PI47	Y-154R
PI48	Y-154RS
PI49	Y-904M1
PI50	Y-954M
PI51	Y-711R
PI57	Y-711RS
PI58	Y-710R
PI59	Y-719RS
PK111	Y-159
PK112	Y-109
PK96	Y-174TS
PK98	Y-171
PM160	Y-274R
PM161	Y-115R1
PM164	Y-733J

HKT	NGK
PM165	CZ256
PM165	CZ256
PM166	Y-115T-1
PM167	CZ257
PM168	Y-1007J
PM169	YE13
PM60	Y-172
PM61	Y-175-2
PM62	Y-102
PM63	Y-201
PM64	Y-802-2
PM65	Y-251
PM66	Y-180
PM70	Y-182T
PM71	Y-172
PM73	Y-274
PM75	Y-115T1
PM78	Y-971M
PM79	Y-114T
PN-81	Y-103
PN120	Y-181T
PN121	Y-204RS
PN122	Y-202-2
PN123	Y-112M1
PN124	Y-162R1
PN125	Y-272R1
PN126	Y-117RS
PN127	Y-117SS
PN128	Y-112R1
PN129	Y-204SS
PN130	Y-272T
PN131	Y-755RS
PN132	Y-705RS
PN133	Y-144SS
PN134	Y-144RS
PN135	Y-707RS
PN136	Y-757RS
PN137	Y-955RS
PN138	T-712RS
PN82	Y-252
PN84	Y-202
PN85	Y-103-1
PN86	Y-103-2
PN87	Y-112T
PN88	Y-177-1



GLOW PLUG CONVERSION CHART

MOTORCRAFT TO NGK



 HKT	 NGK
PN89	Y-204TS1
PS200	Y-149
PS201	Y-103V
PS202	Y-106V
PS203	Y-107V
PS204	Y-106-1
PS205	Y-701R
PS206	YE01
PS207	Y-709R
PS209	Y-119V
PS210	Y-702U
PS215	Y-766MS
PS216	Y-145T
PS217	Y-182T-1
PS219	YA-01
PT-93	Y-128
PT100	Y-128T
PT101	Y-178T
PT102	Y-173
PT103	Y-118T1
PT104	Y-128T
PT107	Y-146R
PT108	Y-197T
PT109	Y-178T
PT140	Y-118R
PT141	Y-197R
PT142	Y-168R
PT144	Y-118T1
PT145	Y-147T
PT147	Y-146R
PT150	Y-703R
PT151	Y-715R
PT151M	Y-118T-1
PT152	Y-532J
PT153	Y-532J
PT154	Y-532J
PT155	Y-715R
PT157	Y-531J
PT158	Y-744M
PT37	Y-701R
PT90	Y-402-2
PT91	Y-452-1
PT92	Y-173
PT94	Y-178
PZ30	Y-107T

 HKT	 NGK
PZ31	Y-157R
PZ32	Y-157R
PZ33	Y-107R
PZ34	Y-122
PZ36	Y-721RS
PZ39	Y-701J

 Honda	 NGK
PZ701	Y-771R

 Motorcraft	 NGK
1037204	Y-732J
1056857	Y-937J
1079401	Y-524J
1096527	Y-525J
1690048	Y-741U
3252725	Y-107R
5023372	Y-208T
5031006	Y-924J
6132246	Y-907R
6154593	Y-924J
7088988	Y-910J
84BB6M090AA	Y-924J
84FF6M090B2A	Y-907R
93FF6M090AA	Y-910J
95VV6M090AB	Y-732J
96FF6M090CA	Y-937J
EZD1	Y-810
EZD10	Y-918J
EZD18	Y-115T1
EZD19	Y-128T
EZD20	Y-117RS
EZD21	Y-118T1
EZD22	Y-107T
EZD30	Y-924J
EZD39	Y-937J
EZD40	YE04
EZD41	Y-504J
EZD5	Y-924J
V94DX6M090AA	Y-924J
V95DD6M090AA	Y-741U
XM3412A342BA	Y-701J
XS4U6M090AB	Y-524J
XS7U6M090BA	Y-525J



GLOW PLUG CONVERSION CHART

YANMAR TO NGK



Other	NGK
12625507	Y8011AS
1820A019	CZ267
22439AA000	Y-606J
25181860	Y8010AS

Proton	NGK
68029497AA	Y8011AS

Toyota	NGK
1850-0W010	Y-542J
19850-26010	Y-1012J
19850-27010	Y-531J
19850-30010	Y-531J
19850-54030	Y-118T1
19850-54031	Y-118T1
19850-54050	Y-118R
19850-54060	Y-168R
19850-54090	Y-715R
19850-56012	Y-178T
19850-56021	Y-128T
19850-56022	Y-128T
19850-64010	Y-146R
19850-64020	Y-703R
19850-64031	Y-532J
19850-64050	Y-532J
19850-68010	Y-147T
19850-68020	Y-197T
19850-68030	Y-128T
19850-68040	Y-178T
19850-68060	Y-197R

Yanmar	NGK
Y1021J	Y-107R



SPARK PLUG CONVERSION CHART

AC TO NGK



AC	NGK
41-100	IZTR4A-11
41-101	ILTR4A-15
41-103	ILTR5B-11
41-105	ILTR5C-11
41-107	ILTR6B-11
41-109	ILTR6E-11
41-110	TR55IX
41-267	BKR4E-11
41-600	TR55IX
41-601	BPR6ES
41-602	FR5
41-603	FR4
41-606	TR55
41-608	FR45
41-610	FR4
41-611	FR45
41-627	BKR4E-11
41-628	BKR4E-11
41-629	BKR5ES
41-812	TR6IX
41-900	TR5
41-902	TR55
41-904	TR5
41-905	UR4
41-906	TR5
41-907	TR5
41-908	BPR5EFIX-13P
41-910	TR5
41-913	TR55
41-919	TR55
41-921	TR55
41-928	TR55-1
41-929	TR55IX
41-932	TR55IX
41-933	PTR4B-15
41-936	TR55
41-940	TR55
41-942	TR55
41-943	TR55
41-947	TR55
41-948	TR4IX
41-950	PTR5C-13
41-952	BPR5EFIX-13P
41-963	PTR5C-13
41-974	PZTR5A-15

AC	NGK
41-983	PZTR5A-15
41-985	ITR6F-13
41-987	PTR5C-13
41-988	LTR6AP-11
41-993	PTR4G-15
412XLS	BP7ES
414XLS	BP6ES
41F	B6HS-10
41TS	BP6FS
41XL	B9ES
41XLS	BP7ES
420Z	B-4H
422Z	B5HS
425F	B6HS
426FS	BP6HS
42F	B6HS
42FF	B6HS
42FS	BP6HS
42S	BP6S
42TS	BP6FS
42XL	B8ES
42XLS	BP6ES
430Z	B7HS
436XLS	BP9ES
43F	B6HS
43FFS	BP6HS
43FS	BP6HS
43N	B7ES
43S	BP6S
43TS	BP6FS
43XL	B7ES
43XLS	BPR6EY
44	B6S
440T	B7FS
440XLS	BP8ES
445Z	B8HS
44F	B5HS
44FF	B5HS
44FFS	BP5HS
44N	B6ES
44NS	BP5ES
44S	BP5S
44TS	BP5FS
44XL	B6ES
44XLO	BP5ES

AC	NGK
44XLS	BP5ES
45	B4
45F	B5HS
45FF	B5HS
45FFS	BP5HS
45L	B4L
45NS	BP5ES
45S	BP5S
45TS	BP4FS
45XL	B6ES
45XLS	BP5ES
46	B4
46F	B5HS
46FF	B5HS
46FFS	BP5HS
46N	B5ES
46S	BP5S
46TS	BP4FS
46XL	B5ES
46XLS	BP4ES
47FF	B4H
47S	BP-4
47XL	B4ES
48	B4
83CTS	AP6FS
83TS	AP6FS
84T	A6FS
84TS	AP5FS
85TS	AP5FS
86TS	AP5FS
B4021	B6S
B4031	B4
B43	B6S
B44FS	BP5HS
B44S	BP5ES
B45	B4
C41	B7S
C42-1	B6S
C421	B6S
C42CFS	BP6HS
C42CLTS	BP6EFS
C42CXLS	BP6ES
C42LTS	BP6EFS
C42N	B7ES
C42XLS	BP5ES

AC	NGK
C43	B6S
C43CXLS	BP6ES
C43L	B-6L
C43N	B6ES
C44	B6S
C44N	B6ES
C44NS	BP5ES
C44S	BP5S
C44XL	B6ES
C45	B4
C45L	B4L
C46	B4
C47	B4
C47W	B4
C49	B-2
C73	G-2Z
C75	G-2Z
C81	AB-8
C82	AB-7
C82T	A7FS
C83	AB-7
C83T	A6FS
C84T	A6FS
C85	AB-6
C85TS	AP5FS
C86	AB-6
C87	AB-6
C88	AB-2
C88L	AB-2
CFR1CLS	BCPR7ES
CFR2CLS	BKR6ES
CR42CFS	BPR6FS
CR42CXLS	BPR6ES
CR42N	BR7ES
CR43	BR6S
CR43CXLS	BPR6ES
CR43K	BR6S
CR43N	BR6ES
CR43S	BP6S
CR43TS	BPR5FS-11
CR43TSM	BPR5FS-11
CR44N	BR6ES
CR44NS	BPR5ES
CR44TS	BPR5FS-11
CR45TS	UR4



SPARK PLUG CONVERSION CHART

AC TO **NGK**

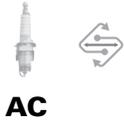

AC



NGK

CR83T	AR6FS
CS40	BM7A
CS41	BM7A
CS41T	BM7F
CS42	BM7A
CS42S	BM7A
CS42T	BM6F
CS45	BM6A
CS45T	BM6F
CS49	BM4A
CSR45	BMR6A
FR2LS	BKR6ES
FR2LSK	BKR6ES
FR3CLS	BKR5ES
FR3CLS6	BKR5E-11
FR3LM	ZFR5A-11
FR3LS	BKR5ES
FR3LS6	BKR5E-11
FR3LSJ	BKR4E-11
FR3LSK	BKR5ES
FR4LE	ZFR4F-11
FR4LSJ	BKR4E-11
FR5LS	BKR5E
JR42XLS	BPR6EY
LM46	B4-LM
LM49	B4-LM
M40FF	B9HS
M40FFX	B9HS-10
M41FF	B8HS
M41K	B8S
M42FF	B7HS
M42K	B7S
M43FF	B6HS
M43S	BP6S
M44B	B6S
M44C	B6S
M44L	B6L
M45	B-4
M45FF	B5HS
M47	B4
M86	AB-6
M90	B9S
MB42K	B6S
MC104F	C6HSA
MC121F	D10HS

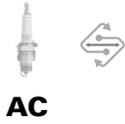

AC



NGK

MC122F	D8HA
MC124FS	D6HA
MC41	B8S
MC41F	B8HS
MC42	B8S
MC42F	B7HS
MC44	B7S
MR42K	BR6S
MR42LTS	BPR6EFS
MR43LTS	BPR5EFS
MR43T	BR6FS
MR44C	BR6S
MR44T	BPR5FS-15
MR45	B-4
R415TS	BPR6FS
R41CF	BR7HS
R41CXL	BR9ES
R41CXLS	BPR7ES
R41TS	BPR6FS
R425LTS	BPR6EFS
R425TS	BPR6FS
R426FS	BPR6HS
R42CF	BR6HS
R42CFS	BPR6HS
R42CLTS	BPR6EFS
R42CT	BR6FS
R42CTS	BPR6FS
R42CXL	BR8ES
R42CXLS	BPR6ES
R42FS	BPR6HS
R42LTS	BPR6EFS
R42LTSM	BPR5EFS-13
R42S	BP6S
R42T	BR6FS
R42TS	BPR6FS
R42TSM	BPR6FS
R42TX	BR6FS
R42XL	BR8ES
R42XLS	BPR6ES
R42XLISM	ZGR5C
R43	BR6S
R43C	BR6S
R43CFS	BPR6HS
R43CNTSE	TR5-1
R43CS	BP6S

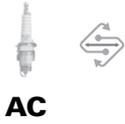

AC



NGK

R43CT	BR6FS
R43CTS	BPR6FS
R43CTS6	BPR6FS
R43CXL	BR7ES
R43CXLS	BPR6ES
R43FS	BPR6HS
R43LTS	BPR6EFS
R43LTSE	TR4
R43LTSX	BPR6EFS-13
R43N	BR7ES
R43NTSE	TR5-1
R43S	BP6S
R43T	BR6FS
R43TS	BPR6FS
R43TSK	BPR6FS
R43TSX	BPR6FS
R43TX	BR6FS-15
R43XL	BR7ES
R43XLS	BPR6ES
R44	BR6S
R44CF	BR5HS
R44CNTSE	TR5-1
R44CXL	BR6ES
R44CXLS	BPR5ES
R44F	BR5HS
R44LTS	BPR5EFS
R44LTS6	BPR5EFS-13
R44LTS6K	BPR5EFS-13
R44LTSM	TR4
R44LTSM6	TR4
R44N	BR6ES
R44NS	BPR5ES
R44NTSE	TR5-1
R44S	BP5S
R44T	BPR5FS-15
R44TS	BPR5FS
R44TSX	BPR5FS-15
R44TX	BPR5FS-15
R44XL	BR6ES
R44XLS	BPR5ES
R44XLS6	BPR4ES-13
R44XLSE	ZGR5C
R44XLISM	ZGR5C
R45	BR6S
R45LTS6	BPR5EFS-13

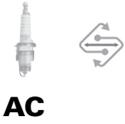

AC



NGK

R45LTS6K	BPR5EFS-13
R45NS	BPR5ES
R45NSX	BPR5ES-13
R45NTSE	TR5-1
R45S	BP5S
R45T	BPR5FS-15
R45TS	BPR4FS
R45TSX	BPR4FS-15
R45XL	BR6ES
R45XLS	BPR5ES
R46	BR6S
R46LTS	BPR5EFS
R46N	BR5ES
R46S	BP-4
R46SZ	XR45IX
R46T	BPR5FS-15
R46TS	BPR4FS
R46TSX	BPR4FS
R46TX	BPR5FS-15
R46XL	BR5ES
R46XLS	BPR4ES
R47S	BP-4
R83CT	AR6FS
R83CTS	APR6FS
R83TS	APR6FS
R84TS	APR5FS
R85TS	APR5FS
S102F	C7HSA
S104F	C6HSA
S121F	D8HA
S121XL	D8EA
S122F	D8HA
S123XL	D7EA
S124FS	D6HA
S404XLG	B10EG
S408XLG	B9EG
S40F	B9HS
S40FR	BR9HS
S40XL	B10ES
S40XLG	B9ECS
S40XLR	BR8ES
S41F	B8HS
S41FG	B7HCS
S41FR	BR8HS
S41XL	B9ES



SPARK PLUG CONVERSION CHART

AUTOLITE TO NGK



AC	NGK
S41XLG	B8ECS
S41XLR	BR9ES
S42	B7S
S42F	B7HS
S42FR	BR7HS
S42XL	B8ES
S42XLR	BR8ES
S43XL	B7ES
S43XLR	BR7ES
S44	B6S
S44F	B5HS
S44XL	B6ES
S45F	B5HS
S46	B-4
S81F	AB-8
S82F	AB-8
S83F	AB-7
S85F	AB-6
SB41	B7S
SN46	B-4
SV41XL	BUE
SV4XL	BUE
TC42	B8S
TC45	B6S
TC49	B-2
TC81	AB-8
TC82	AB-8
TC83	AB-7
TC85	AB-6
TC86	AB-6
V40	B9S
V40FFK	BUHW-2
V40FFM	BUHW
V40FFS	BUH
VB40FFM	BUHXW-1
VR40FFK	BUZHW-2

Aprilla	NGK
VR40FFM	BUZHW

Autolite	Autolite
102	BP7EFS
103	BPR6EFS
104	BPR6EFS
105	BPR5EFS
106	BPR5EFS
112	A9FS
113	A7FS
115	A6FS
117	A6FS
12	BP7FS
124	AR6FS
13	BP6FS
135	B7FS
136	BR6FS
14	BP6FS
143	BR6FS
144	BR6FS
145	BR6FS
146	BPR5FS-15
147	BPR5FS-15
15	BPR5FS-15
156	AP5FS
16	BP4FS
166	APR5FS
175	BP5S
203	BPR6FS
215	B6L
216	B6L
217	B4L
218	B4L
2272	AB-7
23	BPR6FS
235	BM6A
24	BPR6FS
2413	B10EG
2414	B10EG
2415	B9EG
2416	B8EG
2417	B7ECS
245	BMR6A
25	BPR5FS
253	BM7A
254	BM6A
2543	TR5-1
2544	TR5-1

Autolite	NGK
2545	TR5-1
2546	TR5-1
255	BM6A
258	BM4A
2585	BPR5ES
2592	B10ES
2593	B9ES
2594	B9ES
26	BPR4FS-15
2611	B10ES
2612	B9ES
2613	B9ES
2614	B8ES
2615	B7ES
2616	B6ES
2634	B9HS-10
2635	B8HS
2636	B7HS
2652	B9HS-10
2653	B7HS
2654	B7HS
2655	B6HS
2656	B5HS
2675	B-6L
2676	B-6L
2695	AB-8
2696	AB-7
2697	AB-6
27	BPR4FS-15
2715	D8HA
2716	D6HA
273	BP6HS
2735	D6HA
274	BP6HS
275	BP5HS
2755	D8EA
276	BP5HS
2772	AB-8
2775	AB-6
2794	C8HSA
2795	C7HSA
2796	C6HSA
283	BPR7HS
284	BPR6HS
2852	BUH



SPARK PLUG CONVERSION CHART

AUTOLITE TO NGK



Autolite	NGK
2872	BUHW
2892	BUHX
292	B8S
2932	BUE
294	B6S
295	B-4
2954	BM7F
2956	BM6F
297	B-4
2974	BPM7A
2976	BPMR7A
298	B-2
3012	B8S
3013	B7S
3014	B6S
3017	B-4
302	BR6S
303	BR6S
3035	AB-6
3036	BPR4FS-15
3036	BPR4FS-15
304	BR6S
3055	A6FS
306	B-4
3074	G-2Z
3075	G-2Z
308	B-2
3116	AB-6
3116	AB-6
312	B8S
313	B7S
3136	CMR6A
314	B6S
315	B6S
316	B6S
317	B-4
318	B-2
32	AP7FS
3203	BPR6ES
3204	BPR6ES
3205	BPR5ES
3206	BPR5ES
3207	BPR5ES
3224	BP6S
3225	BP5S

Autolite	NGK
3226	BP5S
3227	BP5S
3227	BP5S
3243	BPR6EFS
3244	BPR6EFS
3245	BPR5EFS
3246	BPR5EFS
3264	B7FS
3265	BR6FS
3266	BPR5FS-15
3267	BPR5FS-15
3286	APR6FS
33	AP6FS
3303	BPR6FS
3325	B-6L
3327	B-4L
3345	BMR7A
3364	BPR6HS
3382	BR6S
3383	BR6S
3384	BR6S
3386	BR6S
3388	BR6S
34	AP6FS
3404	AR6FS
3423	B8S
3426	BR6S
344	AR6FS
3462	BR7ES
3463	BR6ES
3464	BR6ES
3465	BR5ES
3466	BR5ES
3485	BR5HS
3486	BR5HS
35	AP5FS
3507	B-6L
353	B8S
354	B6S
355	B6S
356	B-4
3565	BPR5EFS
3565	BPR5EFS
357	B-4
358	B-2

Autolite	NGK
3586	BPR5ES-13
36	AP5FS
3604	BPR5FS-15
3605	BPR4FS-15
3606	BPR4FS-15
3607	BPR4FS-15
3624	BR6FS
3625	BR6FS
3627	BPR5FS-15
363	BR6S
3666	B4-LM
3684	BR7HS
3686	BR6HS
37	AP5FS
3702	BR9ES
3703	BR9ES
3704	BR8ES
3705	BR6ES
3706	BR6ES
372	AB-8
3724	BPR5EFS
373	AB-7
374	AB-7
375	AB-6
376	AB-6
377	AB-6
378	AB-6
379	AB-2
386	AB-6
3885	ZGR5C
3896	ZGR5C
3922	BCPR7ES
3924	BKR6E
3926	BKR5E
393	B7ES
394	B6ES
395	B5ES
3954	D8EA
396	B5ES
3964	DR8ES-L
397	B5ES
398	B4ES
3985	BPR6FS-15
402	BR8ES
403	BR6ES

Autolite	NGK
404	BR6ES
4043	BPR6ES-11
405	BR5ES
4052	B9ES
4053	B9ES
4054	B8ES
4055	B7ES
4056	B6ES
406	BR5ES
4062	BR9ES
4063	BR9ES
4092	B7HS
4093	B7HS
411	B9HS
4113	BP6HS
4114	BP6HS
4123	BPR6HS
413	B7HS
4132	D8EA
414	B6HS
4143	DR8ES-L
415	B5HS
4152	DP9EA-9
4153	DP8EA-9
416	B5HS
4162	DPR9EA-9
4164	D7EA
417	B-4H
4173	D8HA
4193	C7HSA
4203	CR7HS
424	B6HS
425	BR5HS
4251	BP8ES
4252	BP7ES
4253	BP6ES
426	BR5HS
4263	BPR6ES
4265	BPR5ES
4275	BP5S
43	APR6FS
436	B-6L
437	B-4L
44	APR6FS
45	APR5FS



SPARK PLUG CONVERSION CHART

BERU TO NGK



	
Autolite	NGK
456	B4-LM
458	B2-LM
46	APR5FS
472	BPEFS
483	BR7EFS
494	B-6L
495	B-6L
497	B-4L
5143	TR5-1
515	BP5HS
516	BP5HS
517	BP4H
5184	BKR5E
52	BP7ES
5224	BKR5E
53	BP6ES
535	B5HS
536	B-4H
54	BP6ES
55	BP5ES
56	BP5ES
57	BP4ES
584	AR6FS
603	BPR6EFS-13
604	BPR6EFS-13
605	BPR6EFS-13
62	BP7ES
63	BPR6ES
64	BPR6ES
646	BPR5ES-13
65	BPR5ES
66	BPR5ES
664	BPR6FS
665	BPR5FS-15
666	BPR4FS-15
667	BPR4FS-15
67	BPR4ES
683	BR6FS
684	BR6FS
685	BR6FS
687	BR5FS
723	BPR6FS
724	BPR6FS
725	BPR5FS-11
726	BPR4FS

	
Autolite	NGK
727	BPR4FS-11
73	BP6S
74	BP6S
744	APR5FS
746	APR5FS
747	APR5FS
75	BP5S
76	BP5S
763	TR5-1
764	BPR6EFS
765	BPR5EFS
766	BPR5EFS
77	BP-4
784	AR6FS
804	AR6FS
84	BP6S
85	BP5S
86	BP-4
865	BPR5EFS
87	BP-4
884	BPR6EFS-13
9062	BP6ET
9063	BP6ET
9064	BP5ET
915	ZGR5C
925	ZGR5C
935	BPR5ES
94	BP7EFS
945	BPR5ES
985	ZFR4F-11
9921	BCPR6ET
996	B-6L
AP63	PFR6B

	
Bajaj	NGK
APP392411	BKR5EP-11

	
Beru	NGK
RER6YCA	CR9E
1325701	BP5ES
1325704	BP5ESZ
1325705	BCP5ES
1325710	BP5ET
1330104	BUR5ET
1330112	BUR5ET-10
1330113	BUR5ET
1330116	BKUR5ET-10
1330119	BKUR5ET
1330501	BKR6EK
1330702	BP5ES
1330707	BCP5ES
1330709	BP5ET-10
1330713	BP5ESZ
1330717	ZFR5F
1330718	ZGR5A
1330725	BCP5ES
1330726	BP5ESZ
1330731	BCP5ES
1330780	BKR6EZB
1330904	IFR5D-10
1335107	BKUR6ET-10
1335108	BUR6ET
1335702	BP6ES
1335709	BP6ET
1335714	BP6ESZ
1335721	BCP6ES
1335725	BCP6ES
1335729	BKR6ES
1335732	BKR6EK
1335737	BP6ESZ
1335742	ZFR5P-G
1335905	IFR6D-10
1335910	IFR6D-10
1335911	PZFR5D-11
1335914	PFR6Q
1340103	BKUR6ET
1340702	BP6ES
1340704	BP6ET
1340706	BCP6ET
1340707	BP6ESZ
1340716	BCP6ES
1340717	BCP6ET
1340723	BKR6ES



SPARK PLUG CONVERSION CHART

BERU TO NGK



 Beru	 NGK	 Beru	 NGK	 Beru	 NGK	 Beru	 NGK
1340806	BKR6ES	2335712	BKR6EY	144B2	BP7HS	14F7DU0	BCP6ES
1340903	BP6ES	2335713	BKR6EYA	144C1	B8ES	14F7DUOR	BKR6ES
1340908	PFR7Q	2335714	BKR6EYA-11	144C2	B7ES	14F7HPURX2	PZFR5D-11
1345702	BP7ES	2335715	ZFR6F-11	144CS1	BR8EIX	14F7HUR2	ZFR5P-G
1345704	BP6ET	2335719	LF6B	144DPO	BP7ES	14F7LDUR4	BKR6EK
1345711	BP7ES	2335902	BCPR6EP-11	145A	B7HS	14F8DU	BCP5ES
1345720	BCP7ES	2335903	BCPR6EP-11	145AU	B7HS	14F8DU4	BCP5ES
1350903	BP7ES	2335904	BKR6EP-8	145B	BP7HS	14F8DU0	BCP5ES
1430700	BP5HS	2335911	BKR6EQUP	145BU	BP7HS	14F8DUR	BKR6EZB
14307001	B5HS	2340102	BKR6EKUB	145C	B7ES	14F8LDUSR	BKR6EK
1435700	BP6HS	2340500	BKR6EK	145CS	B7ECS	14F8LUR	ZFR5F
1440700	BP6HS	2340501	BKR6EKE	145D	BP7ES	14F9DU0	BCP5ES
1445700	BP7HS	2340504	BKR6EKC	145D1	BP7ES	14FGH6DTUR	BKUR6ET
1625700	BP5EFS	2340701	BPR6ES	145DP1	BP7ES	14FGH7DPURX2	IFR6D-10
1625702	BP5EFS	2340702	BKR6ES	145DTU	BP6ET	14FGH7DTURX	BKUR6ET-10
1630700	BP5EFS	2340703	BPR6ES-11	145DU	BP7ES	14FGH8DPURX2	IFR5D-10
1630704	BP5EFS	2340704	BKR6ES-11	145DU0	BP7ES	14FGH8DTURW	BKUR5ET
1635700	BP6EFS	2345701	BPR7ES	145E	B7S	14FGH8DTURX0	BKUR5ET-10
1635709	BP6EFS	2345702	BCPR7ES	146BU	BP6HS	14FGR6DDU	BKR6EKUB
1640700	BP6EFS	2345704	BCPR7ET	146DPO	BP6ES	14FGR7CTU	BCPR7ET
1640704	BP6EFS	2435701	BPR6HS	146DTU	BP6ET	14FLR8LDUX	BKR5EK
1640705	BP6EFS	2630701	PTR5A-13	146DU	BP6ES	14FR5DTU	BCPR7ET
1645700	BP7EFS	2630715	LTR6B-10T	146DU0	BP6ESZ	14FR5DU	BCPR7ES
1645703	BP7EFS	2630900	TR55	147BU	BP6HS	14FR6DU	BKR6ES
1735700	AP6FS	2635700	BPR6EFS	147DTU	BP6ET	14FR6DUX	BKR6ES-11
1740700	AP6FS	2635701	BPR6EFS-13	147DU	BP6ES	14FR6LDU	BKR6EK
2235901	PLZKBR7A-G	2640100	BUR6EFSZ	147DU0	BP6ESZ	14FR6LDU3	BKR6EKE
2325700	BPR5ES	2640700	BPR6EFS	148AU	B5HS	14FR6LDUW	BKR6EKC
2330204	BKR5EYA-11	2640701	BPR6FS	148BU	BP5HS	14FR7DQUP7	BKR6EQUP
2330701	BPR5ES	2640900	PTR5A-13	148DTU	BP5ET-10	14FR7DU	BKR6ES
2330702	BPR5ES-11	12-5DU	D7EA	148DU	BP5ES	14FR7DUX	BKR6ES-11
2330703	BKR5ES	12ZR6SP03	PLZKBR7B8DG	148DU0	BP5ESZ	14FR7KPU	BKR6EP-8
2330704	BKR5ES-11	12ZR6SP2	PLZKBR7B8DG	148LUR	ZGR5A	14FR7KPUV	BCPR6EP-11
2330706	BPR5EKU	12ZR6SPP21	PLZKBR7B8DG	149DTU	BP5ET	14FR7KPUX	BCPR6EP-11
2330710	BKR5EK	12ZR7SP03	PLZKBR7B8DG	149DU	BP5ES	14FR7KU	BKR6EY
2330712	BCRE527Y	142AS1	B9HCS	149DU0	BP5ESZ	14FR7KU0	BKR6EYA
2330713	BKR5EY	143A1	B8HS	14F5DU	BCP7ES	14FR7KUOX	BKR6EYA-11
2330714	BKR5EYA	143AS1	BR8HIX	14F6DPUR021	PFR7Q	14FR7LDU	BKR6EK
2335100	BCPR7ET	143AU	B8HS	14F6DSR	BKR6ES	14FR7LUX	ZFR6F-11
2335500	BKR6EK	143CS1	BR8EIX	14F6DTU	BCP6ET	14FR7MU2	LF6B
2335701	BPR6ES	143DP2	BR8EIX	14F6DU0	BCP6ES	14FR8DU	BKR5ES
2335704	BR6ES	144A1	B8HS	14F6DUOR	BKR6ES	14FR8HU	BCRE527Y
2335706	BPR6ES-11	144A2	B7HS	14F7DPUR02	PFR6Q	14FR8KU	BKR5EY
2335707	BKR6ES	144AS1	BR8HIX	14F7DPURX2	IFR6D-10	14FR8KU0	BKR5EYA
2335708	BKR6ES-11	144AU	B7HS	14F7DU	BCP6ES	14FR8KUOU	BKR5EYA-11



SPARK PLUG CONVERSION CHART

BERU TO NGK



Beru	NGK
14FR8LDUOX4	BKR5EK
14G8DTU	BUR5ET
14GH7DTUR	BUR6ET
14GH8DTUR	BUR5ET
14GH8DTURX	BUR5ET-10
14GR8DTU	BPR5EKU
14K5DU	BP7EFS
14K5DUO	BP7EFS
14K6DU	BP6EFS
14K6DUO	BP6EFS
14K7DU	BP6EFS
14K7DUO	BP6EFS
14K8DU	BP5EFS
14K8DUO	BP5EFS
14K9DU	BP5EFS
14K9DUO	BP5EFS
14KGR6KQU	BUR6EFSZ
14KR6BU	BPR6FS
14KR6DU	BPR6EFS
14KR6ZPPV	PTR5A-13
14KR7DU	BPR6EFS
14KR7DUX	BPR6EFS-13
14KR8DPUOV	TR55
14KR8MPX	PTR5A-13
14KR8MUV	PTR5A-13
14KR8STUX	LTR6B-10T
14R5DU	BPR7ES
14R6BU	BPR6HS
14R6DU	BPR6ES
14R6DUX	BPR6ES-11
14R7BU	BPR6HS
14R7CU	BR6ES
14R7DU	BPR6ES
14R7DUX	BPR6ES-11
14R8DU	BPR5ES
14R8DUX	BPR5ES-11
14R9DU	BPR5ES
14SGR16KQU	BKR7EQUP
18K12B	AP5FS
18K6BU	AP6FS
18K7BU	AP6FS
18K8BU	AP5FS
3167	ZFR4F-11
3168	PFR6B-11
D15Y	BCP6ES

Beru	NGK
K20TT	ZFR6U-9
RS16	BPR6HIX
RS33	BPR5EIX
RS35	BPR6EIX
Z1	BP5ES
Z10	BP6HS
Z100	BKR6ES
Z101	BKR6EK
Z103	BP7ES
Z104	BP6ES
Z105	BKR6E
Z107	BP-4
Z11	BP6ES
Z112	B4
Z12	BP6ET
Z13	BKR6E
Z14	BKR6EK
Z144	BUR6EFSZ
Z145	BKR6EKUB
Z148	TR55
Z149	BCPR6EP-11
Z15	BKR6E
Z150	BCPR6EP-11
Z151	BKR6EP-11
Z152	BCRE527Y
Z153	BKR5EY
Z154	BKR5EYA
Z155	BKR6EY
Z156	BKR6EYA
Z157	BKR6EYA-11
Z158	ZFR6F-11
Z16	BCPR6ES-11
Z17	BP6EFS
Z18	BP6EFS
Z19	BPR6HS
Z2	BP5ET
Z20	BPR6ES
Z21	BPR6ES-11
Z22	BP6ES
Z23	BKR6E
Z24	BKR6E
Z25	BP6EFS
Z26	BPR6EFS
Z27	BPR6ES
Z28	BPR6ES-11

Beru	NGK
Z29	BCP7ES
Z3	ZGR5A
Z30	BCPR7ES
Z31	BP7EFS
Z32	AP6FS
Z33	AP6FS
Z35	D7EA
Z36	D7EA
Z366	SILZKGR8B8S
Z37	B9HS
Z38	B9ES
Z39	B8HS
Z4	ZFR5F
Z40	B7HS
Z41	BP7HS
Z42	BP7ES
Z43	BP7ES
Z44	BP6ET
Z45	BCPR7ET
Z46	BP7EFS
Z47	BPR7ES
Z48	BP6HS
Z49	BPR6FS
Z5	BCP5ES
Z50	BP6ESZ
Z51	BP6ET
Z52	BCP6ET
Z53	BCP6ET
Z54	BCP6ES
Z55	BP6EFS
Z56	BP6EFS
Z57	B6HS
Z58	B6ES
Z59	BR6ES
Z6	BP5EFS
Z60	BCPR7ET
Z61	BP6ESZ
Z62	BP6ESZ
Z63	BCP6ES
Z64	BCP6ES
Z66	BP6EFS
Z67	BPR6EFS-13
Z68	B5HS
Z69	BP5ESZ
Z7	BP5EFS

Beru	NGK
Z70	BP5ESZ
Z71	BCP5ES
Z72	BCPR5ES
Z73	BCPR5ES-11
Z74	BKR5EK
Z75	BUR5ET
Z76	BP5ES
Z77	BP5ESZ
Z78	BP5ET
Z79	BCP5ES
Z8	BPR5ES
Z80	BP5EFS
Z81	BP5EFS
Z82	BPR5ES
Z83	B4-LM
Z84	BR4-LM
Z85	B6HS
Z86	AB-7
Z87	AB-7
Z88	AB-6
Z89	BKUR6ET
Z9	BPR5ES-11
Z90	BKUR6ET-10
Z91	BUR6ET
Z92	BUR5ET
Z93	BUR5ET-10
Z94	BPR5EKU
Z95	BPR6EFS
Z97	PTR5A-13



SPARK PLUG CONVERSION CHART

BMW TO **NGK**



BMW **NGK**

BMW	NGK
Z99	BCPR6ES-11



Bosch **NGK**

240235545	BR6ES-11
241040501	CR4HSA
241045001	C5HSA
241045003	C5HSA
241045502	C5HSA
241050002	C6HSA
241056501	C7E
241135515	ZKER6A-10EG
241140522	SILZKFR8D7S
241145003	DP7EA-9
241145500	DP7EA-9
241145504	DP7EA-9
241145507	D8EA
241145515	PZKER7A8EGS
241150502	D8EA
241200500	BUH
241209003	B-4H
241219536	BP-4
241219537	BP4FS
241219537	BP4FS
241219540	B4H
241219541	B4ES
241219542	BP4ES
241219543	B4H
241219554	B4
241219555	BP4ES
241225013	BP5ES
241225543	BP4FS
241225545	BP5ES
241225547	B4ES
241225548	B4
241225549	B5HS
241225550	BP5ES
241225551	B4-LM
241225555	BPR4FS-15
241225556	BP5ES
241225558	BP5EFS
241225573	BP5EFS
241225574	BCPR4ES-11
241225576	BP5ET
241225582	BP5ES-11
241225585	ZGR5A
241225589	BM4A
241225590	B4-LM
241225593	BP5ES



Bosch **NGK**

241229059	ZGR5A
241229060	BP5ET-10
241229061	BP5ES
241229062	BP5ES
241229541	BM6F
241229560	BM6A
241229561	BPM6A
241229574	BP5ES
241229578	BP5HS
241229579	B5ES
241229580	B6S
241229588	BP5ES
241229593	BP5S
241229594	BP5FS
241229596	BP5ES-11
241229604	B5HS
241229612	B5HS
241229617	BP5EFS
241229619	BP5ET
241229634	BGP5ES
241229636	BPR5FS-11
241229639	ZFR5F
241229641	BP5HS
241229649	BP5EFS
241229657	ZFR5F
241229661	BUR6ET
241229663	BUR6ET-10
241229665	BUR5ET
241229666	BKR6EK
241229676	BKUR5ET
241229682	BGP5ES-11
241229684	BKR5ES
241229704	IFR5D-10
241229712	BGP5ES
241229713	BGP5ES
241229714	BP5HS
241229715	BP5ES
241229716	BP5ET
241229853	BP5ES
241229926	BP5ES
241235089	B6ES
241235098	B6ES
241235099	BPR6ES
241235103	BP6ESZ
241235108	BGP6ET



Bosch **NGK**

241235563	BP6ES
241235564	BP6HS
241235566	BM6A
241235567	BPM6A
241235574	B6ES
241235585	BP6HS-10
241235594	B6S
241235602	BP6ES
241235607	B6HS-5
241235610	BP6ES-11
241235619	B6HS-5
241235623	BP6S
241235633	BUR6ET
241235635	BP6EFS
241235636	BP6EFS
241235638	BR6EF
241235643	BUR6ET
241235668	BP6EFS
241235673	BGP6ES
241235674	ZFR6A-11
241235676	BGP6ES
241235681	BP6EFS
241235685	BGP6ES-11
241235690	BKR6EK
241235692	ZFR6F-11
241235693	BP6ESZ
241235698	BUR6ET
241235705	BP6ESZ
241235706	BKUR6ET-10
241235715	PZFR5D-11
241235730	ZFR5P-G
241235735	ZFR5P-G
241235736	BKR6ES
241235739	IFR6D-10
241235750	BGP6ES
241235751	BKR6EK
241235752	BKUR6ET-10
241235753	BP6EFS
241235754	BP6HS
241235755	BP6ES
241235756	BUR6ET
241235757	BUR6ET
241240057	BP6EFZ
241240058	BP6ESZ
241240524	BP6EFS



SPARK PLUG CONVERSION CHART

BOSCH TO NGK



 Bosch	 NGK
241240530	BP6ES
241240532	BP6HS
241240539	BP6ES
241240542	BCP6ES
241240543	BP6FS
241240558	BUR6ET
241240563	BP6EFS
241240564	BCP6ET
241240569	BCP6ES-11
241240574	BP6ES-11
241240578	BP6EFS
241240585	BKR6EIX
241240587	BKR6ES
241240592	BKUR7ET
241240600	BM6A
241240601	BPM6A
241240608	BCP6ES
241240609	BCP6ET
241240611	BP6ES
241240631	ILFR6A
241243501	BPR6EIX
241245070	BUR6ET
241245539	BM7F
241245552	BP7ES
241245553	BP7HS
241245554	BM7A
241245555	BPM7A
241245570	BP7EFS
241245574	BR7HIX
241245575	BR7EIX
241245580	B7HS
241245581	B7ES
241245592	B7S
241245599	BP7ES
241245602	B7HS
241245603	B7ES
241245619	BP7HS
241245636	BP7EFS
241245641	PFR7B
241245642	BCP7ES
241245646	BP7HS-10
241245655	BCP7ES
241245656	BP7HS
241245673	PLFER7A8EG
241247500	BPR7EIX

 Bosch	 NGK
241248531	B8HS
241248534	B8ES
241248538	B8ES
241248540	B8HS
241250502	BPR8EIX
241250512	BPR8EIX
241250526	R7433-8
241252521	BR8HIX
241252522	BR8EIX
241255505	B8EFS
241255507	R7433-9
241256512	B8HS
241256513	B9ES
241256514	BR8HIX
241256515	BR9EIX
241256517	BPR8EIX
241256519	B8HS
241256522	B9ES
241260507	B9HS
241260510	BP6EFS
241260512	R7433-9
241262505	BR9HIX
241262506	BR10EIX
241268505	BR9HIX
241268506	BR10EIX
241274504	BR10HIX
241274505	BR10EIX
241280503	BR10EIX
242035500	CMR6H
242040500	CR6HS
242050500	CR6HS
242055500	CR7HS
242055501	CR7HSA
242055502	CR7E
242055505	CR7HSA
242060500	CR8HS
242060501	CR8E
242129500	PFR7G-11
242129503	LZKAR7A
242129508	LZKAR7A
242129512	PLZKBR7B8DG
242129804	PLZKBR7B8DG
242135500	DPR7EA-9
242135501	DCPR8E-N
242135509	PLKR7A

 Bosch	 NGK
242135515	ZKR7A-10
242135517	ILZKAR7A-10
242135518	PLZKBR7B8DG
242135524	PLZKAR6A-11
242135554	SILKR6C10E
242140500	DR7EA
242140504	DCPR8EKC
242140512	PLKR7B8E
242140528	PLKR7A
242140557	ILKAR8H-6
242145118	PLZKBR7A-G
242145500	DPR7EA-9
242145501	DPR7EA-9
242145503	DCPR8EKC
242145504	KR9CI
242145516	DPR7EA-9
242145517	SILZKBR8D8S
242145541	SILZKBR8D8S
242145573	ILNAR8B7G
242150500	DR8HS
242150501	DR8ES
242150505	DPR8EA-9
242160501	DR8ES
242214584	SILNAR7B7
242215502	BR4-LM
242219004	BR4HS
242219511	BPR4FS-15
242219512	BP-4
242219513	BP-4
242219514	BR5FS
242219515	BR5FS
242219516	BPR4FS
242219517	BPR4FS-11
242219519	BCPR4ES-11
242219520	BP-4
242219529	ZGR5B
242219530	BPR4ES-13
242225522	BR6S
242225523	BR5ES
242225524	BPR5ES
242225525	BPR5ES-13
242225526	BP5S
242225527	BP5S
242225528	ZGR5C
242225529	BR5FS

 Bosch	 NGK
242225530	BR5FS
242225531	BPR4FS
242225532	BPR4FS-15
242225533	BPR5EFS
242225534	BPR5EFS-13
242225536	BR6S
242225537	ZFR4F-11
242225538	BPR5EIX
242225539	ZGR5A
242225548	BPR5ES-11
242225549	BCPR4ES-11
242225550	BPR5ES
242225553	BPR5ES
242225554	BPR5ES-11
242225560	BPR4FS-11
242225563	BP5S
242225564	BP5S
242225566	BPR4FS-15
242225571	TR5IX
242225573	BPR4FS
242225578	TR55IX
242225582	BKR5ES
242225599	BPR5ES
242225612	BMR4A
242225622	BPR4FS
242225623	TR5
242225624	BPR5ES-11
242225641	BPR4FS-15
242225859	BPR5ES
242225861	BPR5ES
242229524	BR6S
242229525	BP5S
242229526	BR5FS
242229528	BPR5FS
242229529	BPR5FS-15
242229530	BKR5ES-11
242229531	BPR5ES
242229533	BR5ES
242229534	BR5HS
242229537	BPR5EIX
242229538	BPR5ES
242229543	BKR5ES-11
242229544	ZFR5F-11
242229548	BPR5FS
242229549	BPR5FS-11



SPARK PLUG CONVERSION CHART

BOSCH TO NGK



 Bosch		 Bosch		 Bosch		 Bosch	
Bosch	NGK	Bosch	NGK	Bosch	NGK	Bosch	NGK
242229555	BPR5ES	242229797	LF6B	242235588	BKR6ES	242235912	BKR6ES
242229556	BR5ES	242229799	BKUR5ET-10	242235589	BKR6EK	242235913	BKR6ES-11
242229557	BPR5ES-11	242229878	BKR5EK	242235590	BUR6ET	242235914	BKR6EKC
242229566	BPR5ES-11	242229879	BPR5EFS	242235592	BPR6EFS-13	242235915	BPR6ES-11
242229568	BKR5ES	242229880	BPR5ES	242235597	BKR6ES	242235916	PTR5A-13
242229570	BPR5ES	242229881	BKR5HS	242235599	BKR6EY	242235917	BKR6EKUB
242229576	ZFR6F-11	242229882	BUR5ET-10	242235602	BKR6EY-11	242235918	PFR6B
242229587	BKR5ES	242229883	BKR5ES	242235605	BKR6EK	242235925	BKR6ES
242229589	BPR5HS	242229884	BKR5ES-11	242235607	BUR6EFSZ	242235930	BPR6ES
242229591	BKR5EK	242229885	BPR5ES-11	242235609	BKR6EZ	242235931	BUR6ET
242229594	BKR5ES	242229887	BKR5EK	242235610	BKR6EP-13	242235979	BPR6EFS-13
242229598	BKR5EIX	242229888	BKR5ES	242235616	BKR6ES	242235980	BKR6EY
242229605	BKR5EK	242229902	TR5B-13	242235617	BKR6EQUP	242235981	PFR6Q
242229607	BPR5ES	242229923	LF6B	242235624	BKR6ES	242235983	ZFR6T-11G
242229610	BPR5HS	242229925	PFR5R-11	242235630	BPR6ES	242235984	PZFR5D-11
242229613	BKR5EKUP	242229982	BPR5ES	242235636	LF6A	242235985	BKR6EY-11
242229625	BKUR5ET-10	242230500	PFR5R-11	242235640	BKR6EZ	242235986	ZFR6F-11
242229626	BKR5EK	242230806	ZFR5F	242235642	BKR6EKUB	242236510	ILZFR6D-11
242229628	BKR5EK	242235511	BPR6ES	242235651	BPMR6A	242236528	ILFR6B
242229630	LF6B	242235522	BPR6HS	242235656	BKR6EQUP	242236541	BKR6EY-11
242229634	PLFR5A-11	242235525	BPR6EIX	242235659	BKR6EYA-11	242236542	ZFR6F-11
242229635	BKR5EYA-11	242235529	BPR6ES	242235661	BPR6EFS	242236560	BPR6EFS-13
242229641	PTR5D-10	242235530	BPR6ES-11	242235662	PTR5A-13	242236561	BKR6EY
242229648	BKR5EQUA	242235532	BR6ES	242235663	BPR6ES	242236562	BKR6EQUP
242229650	TR5B-13	242235533	BR6HS	242235664	BUR6ET	242236564	PFR6Q
242229654	BKR5EK	242235535	BPR6HS	242235665	BPR6HS	242236565	ZFR6T-11G
242229655	BPR5EFS	242235537	BPR6ES	242235666	BKR6ES	242236566	PZFR5D-11
242229656	BPR5ES	242235538	BPR6EFS	242235667	BKR6ES-11	242236571	LPG1
242229657	BPR5HS	242235541	BPR6EIX	242235690	PFR6N-11	242236577	ILFR6K-8
242229658	BUR6ET-10	242235542	BPR6EFS	242235692	ZFR5E-11	242236583	PFR6X-11
242229659	BKR5ES	242235543	BR6ES-11	242235699	BKR6EIX	242236610	DIFR6A-13G
242229660	BKR5ES-11	242235544	BKR6ES-11	242235707	BPR6ES-11	242236663	ILTR6E11
242229661	LTR6B-10T	242235546	BR6ES	242235715	BKR6EQUA	242236673	DILFR6A-11
242229671	BKR5EKB-11	242235547	BKR5ES-11	242235740	PFR6Q	242239981	BKR6EQUP
242229673	BKR5ES	242235547	PFR6J-11	242235743	PLFR6A-11	242240506	BPMR7A
242229687	BPR5ES-11	242235551	BKR6ES	242235748	BKR6EKUB	242240511	BPR6ES
242229699	ZFR5F	242235554	BR6S	242235749	PFR6B	242240514	BPR6EFS
242229706	BKUR5ET-10	242235556	BKR6E-11	242235761	ZFR5P-G	242240516	BPR6EIX
242229708	ILFR5B-11	242235556	BKR6ES	242235767	PTR5A-13	242240519	BPR6EFS
242229713	PFR5R-11	242235558	BKR6EKC	242235769	ILZFR6C-11K	242240520	BPR6FS
242229724	BKR6EZB	242235564	BCPR6ET	242235776	IZFR6H-11	242240521	BPR6ES
242229779	ZGR5A	242235567	BUR6ET	242235908	BPR6EFS	242240522	BPR6ES
242229781	BKR5EKB-11	242235567	ZFR6F-11	242235909	BPR6ES	242240526	BKR6ES
242229782	BKR5EKB-11	242235579	BKR6ES	242235910	BUR6ET	242240528	BCPR6ET
242229785	TR5B-13	242235587	BKR6ES	242235911	BPR6HS	242240530	BKR6ES



SPARK PLUG CONVERSION CHART

BOSCH TO NGK



 Bosch	 NGK
242240531	BPR6ES-11
242240532	BPR6ES-11
242240533	BKR6ES-11
242240539	BKR6ES-11
242240546	BUR6ET
242240547	BKR5EKC
242240557	BKR6EK
242240561	BPR6HS
242240562	BKR6EZ
242240564	BKR7EKC
242240565	BKR7EKC
242240566	BKR6EK
242240569	BUR6EFSZ
242240572	BKUR6ET
242240576	BPMR7A
242240579	BPR6ES
242240582	BMR6A
242240584	BKR6EKE
242240587	BKR6EQUP
242240590	ZFR6S-Q
242240591	BPR6EFS
242240592	BPR6ES
242240593	BKR6ES
242240605	BKR6ES
242240619	ILFR6A
242240648	BKR6EZ
242240653	LPG1
242240665	PZFR6R
242240848	BPR6EFS
242240849	BPR6ES
242240850	BKR6ES
242240851	BKR6ES
242245015	BPR7EIX
242245018	BKR7EKC
242245514	BPR7EIX
242245515	BCPR7ES
242245517	BR7HS
242245519	BPR7ES
242245520	BCPR7ES
242245521	BR7ES
242245533	BPMR7A
242245536	BCPR7ES
242245537	BPR7ES
242245539	BCPR7ET
242245550	BCPR7ES=-11

 Bosch	 NGK
2422455552	BPR7ES
242245557	BR7ES
242245559	BKR7EQUP
242245571	LPG1
242245576	PFR7S8EG
242245812	BPR7ES
242250503	BR8ES
242250506	BR8HS
242250517	BR8EIX
242255501	BR9ET
242255502	BR9ES
242255504	BR9EIX
242260001	BR10ES
8771207	R2349-10
8874601	R0354H-11
8881101	R2349-11
AGSF22FSM	ITR6F-13
BR8SEW	LZKAR7A
D10B	AP5FS
D10BC	AP5FS
D6B	AP6FS
D6BC	AP6FS
D6BP	AP6FS
D7A	A6FS
D7AC	A6FS
D7B	AP6FS
D7BC	AP6FS
D7BP	AP6FS
D8A	A5FS
D8AC	A5FS
D8B	AP5FS
D8BC	AP5FS
D8BP	AP5FS
D9B	AP5FS
D9BC	AP5FS
DR10B	APR5FS
DR10BC	APR5FS
DR6B	APR6FS
DR6BC	APR6FS
DR6BP	APR6FS
DR7B	APR6FS
DR7BC	AP6FS
DR7BP	APR6FS
DR8B	APR5FS
DR8BC	APR5FS

 Bosch	 NGK
DR8BP	APR5FS
DR9B	APR5FS
DR9BC	APR5FS
F000KE0017	BKUR6ET-10
F000KE0P34	BPR6ES
F000KE0P40	BKR6ES-11
F000KE0P41	BKR5ES-11
F03DAR	BKR6EK
F04DAR	BKR6EK
F2CS	R7433-9
F2DTC	R6888A-9
F3CS	R7433-9
F4CS	R7433-8
F5DC	BCP7ES
F5DP	BCP7ES
F5DPOR	PFR7B
F5DTC	BCP7ET
F5KPP332GF	PFR7S8EG
F5KPP332SB	PFR7S8EG
F6DC	BCP6ES
F6DC0	BCP6ES
F6DCOR	BKR6ES
F6DCX	BCP6ES-11
F6DP	BCP6ES
F6DPOR	PFR6Q
F6DPX	BCP6ES-11
F6DSR	BKR6EIX
F6DTC	BCP6ET
F6KPP332S	PFR6Q
F6LTCR	BKUR7ET
F6MPP332	ILFR6A
F6R7DQP	BKR6EQUP
F7DC	BCP6ES
F7DC0	BCP6ES
F7DCOR	BKR6ES
F7DCX	BCP6ES-11
F7DER	BKR6ES
F7DP	BCP6ES
F7DPER	PFR6G-11
F7DPP332	IFR6D-10
F7DTC	BCP6ET
F7HER02	ZFR6T-11G
F7HER2	ZFR5P-G
F7HPP22	PFR6Q
F7HPP222	PZFR5D-11

 Bosch	 NGK
F7HPP222U	PZFR6J-11
F7HPPRX	PZFR5D-11
F7KPP332U	PFR6X-11
F7KTCR	BKUR6ET-10
F7LCOR2	ZFR6F-11
F7LCR	ZFR6A-11
F7LDCR	BKR6EK
F7LTCR	BKUR6ET-10
F8DC	BCP5ES
F8DC0	BCP5ES
F8DCOR	BKR5ES
F8DC4	BCP5ES
F8DCX	BCP5ES-11
F8DPER	IFR5D-10
F8DPP332	IFR5D-10
F8KTCR	BKUR5ET
F8LCR	ZFR5F
F8LCR2	ZFR5F
F8LDCR	BKR6EK
F9DC0	BCPR4ES-11
F9LCR	ZFR4F-11
FGR5KQEO	BKR7EQUP
FGR5NQEO4	ILFR7H
FGR5NQEO	ILFR7H
FGR6HQEO	ZFR6S-Q
FGR6KQC	BKR6EQUP
FGR6KQE	BKR6EQUP
FGR7DP	BKR6EQUP
FGR7DPP10	BKR6EIX-11P
FGR7DQEO	BKR6EKUB
FGR7DQE+	BKR6EKUB
FGR7DQP	BKR6EQUP
FGR7DQP+	BKR6EQUP
FGR7KQC	BKR6EQUP
FGR7KQE	BKR6EQUP
FGR7KQEO	BKR6EQUP
FGR8KQE	BKR5EKUP
FGR8KQEO	BKR5EQUPA
FGR8MQPE	PLFR5A-11
FL7HTCOR	BKUR5ETC-10
FLR8LDCU	BKR5EK
FLR8LDCU+	BKR5EK
FLR8LDU+	BKR5EK
FLR8LD+U	BKR5EK
FQ5NIPP332S	PLFR7A-8EG



SPARK PLUG CONVERSION CHART

BOSCH TO NGK



 Bosch	 NGK
HR10AY	BR5FS-15
HR10B	BPR4FS
HR10BC	BPR4FS
HR10BCX	BPR4FS-11
HR10BCY	BPR4FS-15
HR10BX	BPR4FS-11
HR10BY	BPR4FS-15
HR6BC	BPR6FS
HR6BP	BPR6FS
HR6D	BPR6EFS
HR6DC	BPR6EFS
HR6DC+	BPR6EFS
HR6DPP33V	ITR6F-13
HR6DS	BPR6EFS
HR7DC	BPR6EFS
HR7DCX	BPR6EFS
HR7DCX+	BPR6EFS
HR7DCY	BPR6EFS-15
HR7DCY+	BPR6EFS-15
HR7DC+	BPR6EFS
HR7DPP22	PTR6F-13
HR7D+	BPR6EFS
HR7MEV	TR5B-13
HR7MPP22U	PTR5A-13
HR7MPP302X	PTR5A-13
HR7MPP+	PTR5A-13
HR7NI332W	LTR6IX-11
HR8A	BPR5FS-15
HR8AC	BPR5FS-15
HR8ACY	BPR5FS-15
HR8AP	BPR5FS-15
HR8APY	BR5FS-15
HR8AY	BR5FS-15
HR8B	BPR5FS
HR8BC	BPR5FS
HR8BCY	BPR5FS-15
HR8BP	BPR5FS
HR8BPX	BPR5FS-11
HR8BPY	BPR5FS-15
HR8BY	BPR5FS-15
HR8DC+	BPR5EFS
HR8DPP22U	PTR5D-10
HR8LCO	TR5-1
HR8LPO	TR5-1
HR8MCV+	TR5B-13

 Bosch	 NGK
HR8MEV	TR5B-13
HR8NPP302	PTR5A-13
HR8NPP302	PTR5A-13
HR9A	BPR5FS-15
HR9AC	BPR5FS-15
HR9ACY	BPR5FS-15
HR9AP	BPR5FS-15
HR9AY	BPR5FS-15
HR9B	BPR4FS
HR9BC	BPR4FS
HR9BCY	BPR4FS-15
HR9BCY+	BPR4FS-15
HR9BC+	BPR4FS
HR9BPX	BPR4FS-11
HR9BPY	BPR4FS-15
HR9BY	BPR4FS-15
HR9D	BPR5EFS
HR9DC	BPR5EFS
HR9DCX	BP5EFS-13
HR9DPY	TR55IX
HS5E	BM7F
HS8E	BM6F
M10A	AB-6
M10AC	AB-6
M10ACO	AB-6
M10AO	AB-6
M12B	AP5FS
M4A	A-7
M4A1	A-8
M5A	A-7
M5AC	A-7
M7A	A-6
M7AC	A-7
M8A	A-6
M8AC	AB-6
M8ACO	AB-6
M8AO	AB-6
U5AC	C5HSA
U6AC	CR4HSA
UR2AS	CR8HS
UR2CC	CR9E
UR3AC	CR7HSA
UR3AS	CR7HS
UR3CC	CR7E
UR4AC	C6HSA

 Bosch	 NGK
UR4AS	CR6HS
UR5	CR7HSA
UR6AC	CR6HS
UR6CC	CR6E
UR6DC	CPR7EA-9
UR6DE	PMR7A
USR7AC	CMR6H
V6SII3328	ILZKBR7B8G
V6SII3328	SILZKFR8E7S
VR5NE	LKAR8BI-9
VR6NII332	ILKAR8H-6
VR7SI332S	ILZKAR7A-10
VR7SPP33	PLZKAR6A-11
VR8SC	LZKAR7A
VR8SC+	LZKAR7A
VR8SE	LZKAR7A
VR8SEW	LZKAR7A
W06AS	B10HV
W06CS	B11EGV
W07AS	BR10HIX
W07CS	B10EGV
W08AS	BR9HIX
W08CS	B10EGV
W10A	B-4H
W10AC	B-4H
W10C	B4ES
W10CC	B4ES
W10D	BP4ES
W10DC	BP4ES
W10E	B-4
W10F	BP-4
W10FC	BP-4
W125T30	BP5ES
W125T6	BP5S
W125TR2	BR5ES
W125TR3	BR6S
W125TR30	BPR5ES
W125TR6	BP5S
W12A	B-4H
W12E	B-2
W145T30	BP5ES
W145T35	BP5HS
W145T6	BP5S
W145TR2	BR5ES
W145TR3	BR6S

 Bosch	 NGK
W145TR30	BPR5ES
W145TR6	BP5S
W160T30	BP5ES
W175T1	B6HS
W175T2	B6ES
W175T30	BP6ES
W175T35	BP6HS
W175T6	BP6S
W175T7	BP6HS
W175TR1	BR6HS
W175TR2	BR6ES
W175TR30	BPR6ES
W175TR35	BPR6HS
W190M11S	BR6HIX
W200T27	BP6ES
W200T30	BP6ES
W200T35	BP6HS
W200TR30	BPR6HS
W215P21	BPR7EIX
W215T30	BP6ES
W220T30	BP6ES
W225S1S	BR7HIX
W225S2S	BR7EIX
W225T1	B7HS
W225T2	B7ES
W225T3	B7S
W225T30	BP8ES
W225T35	BP7HS
W225T7	BPR7HS
W225TR1	BR7HS
W225TR2	BR7ES
W225TR30	BPR7ES
W230T30	BP7ES
W235P21	BP7ES
W235T28	BP8ES
W240M1	B8HS
W240MZ1	B8HS
W240T1	B8HS
W240T2	B8ES
W240T28	B8ES
W240T3	B7S
W250P21	BP7ES
W250T1	B8HS
W250T1	B8HS
W250T2	B8ES



SPARK PLUG CONVERSION CHART

BOSCH TO NGK



Bosch

NGK

W250TR2	BR8ES
W255T30	BP7ES
W260M1	B8HS
W260M1	B8HS
W260M22	B9ES
W260S1S	BR8HIX
W260S2S	BR8EIX
W260T1	B8HS
W260T2	B8ES
W260T20	B8ES
W260T30	BP8ES
W265P21	BPR9EIX
W275T1	B8HS
W275T2	B9ES
W280MZ1	B8HS
W280MZ2	B9ES
W280P21	BP8ES
W280S1S	BR9HIX
W280S2S	BR9EIX
W280T30	BP8ES
W2A	B9HS
W2AC	B9HS
W2AS	BR9HIX
W2CC	B9ES
W2CO	B9ES
W2CS	BR10EIX
W2D	BP9ES
W300T1	B9HS
W300T30	BP9ES
W310S1S	BR9HIX
W310S2S	BR10EIX
W330T1	B9HS
W340S1S	BR9HIX
W340S2S	BR10EIX
W370S1S	BR10HIX
W370S2S	BR10EIX
W3A	B8HS
W3AC	B8HS
W3AO	B8HS
W3AP	B8HS
W3AS	BR8HIX
W3C	B9ES
W3CO	B9ES
W3CC	B9ES
W3CP	B9ES



Bosch

NGK

W3CS	BR9EIX
W3D	BP8ES
W3DP	BPR8EIX
W3DP2	BP8ES
W3DPO	BPR8EIX
W400S1S	BR10HIX
W400S2S	BR10EIX
W4A	B8HS
W4A1	B8HS
W4A2	B8HS
W4A5	B8HS
W4AC	B8HS
W4AP	B8HS
W4AS	BR8HIX
W4C	B8ES
W4C1	B8ES
W4C3	B7HS
W4CC	B8ES
W4CP	BR8EIX
W4CPX	B8ES-11
W4CS	BR8EIX
W4DP	BPR7EIX
W4DPO	BPR8EIX
W4E2	B7S
W5A	B7HS
W5AC	B7HS
W5AP	B7HS
W5AS	BR7HIX
W5B	BP7HS
W5BC	BP7HS
W5BP	BP7HS
W5C	B7ES
W5CC	B7ES
W5CCX	B7ES-11
W5CP	B7ES
W5CPX	B7ES-11
W5CS	BR7EIX
W5D1	BP7ES
W5DC	BP7ES
W5DC0	BP7ES
W5DCX	BP7ES-11
W5DP	BP7ES
W5DPO	BPR7EIX
W5DPX	BP7ES-11
W5DTC	BP6ET



Bosch

NGK

W5EC	B7S
W5EP	B7S
W6AS	B6HV
W6B	BP6HS
W6BC	BP6HS
W6BP	BP6HS
W6D	BP6ES
W6D1	BP6ES
W6DC	BP6ES
W6DC0	BP6ESZ
W6DCX	BP6ES-11
W6DP	BP6ES
W6DPO	BP6ES
W6DPO	BPR6EIX
W6DPX	BPR6EIX
W6DTC	BP6ET
W6LTCR	BUR6ET
W7A	B6HS
W7AC	B6HS
W7AO	B6HS
W7AP	B6HS
W7B	BP6HS
W7BC	BP6HS
W7BP	BP6HS
W7C	B6ES
W7CC	B6ES
W7CC0	B6ES
W7CCX	B6ES-11
W7CP	B6ES
W7CPX	B6ES-11
W7CX	B6ES-11
W7D0	BP6ES
W7DC	BP6ES
W7DC0	BP6ES
W7DCR	BPR6ES
W7DCX	BP6ES-11
W7D0	BP6ES
W7DP	BP6ES
W7DPX	BP6ES-11
W7DTC	BP6ET
W7DX	BP6ES-11
W7E	B6S
W7EC	B6S
W7EP	B6S
W7F	BP6S



Bosch

NGK

W7FC	BP6S
W7LTCR	BUR6ET
W8A	B5HS
W8AC	B5HS
W8AO	B-4H
W8AO	B5HS
W8AP	B5HS
W8B	BP5HS
W8BC	BP5HS
W8BP	BP5HS
W8C	B5ES
W8CCX	B5ES-11
W8CO	B5ES
W8CP	B5ES
W8D	BP5ES
W8DC	BP5ES
W8DC0	BP5ES
W8DCX	BP5ES-11
W8DCY	BP5ES-13
W8DP	BP5ES
W8DPX	BP5ES-11
W8DTC	BP5ET
W8DX	BP5ES-11
W8E	B6S
W8EC	B6S
W8F	BP5S
W8FC	BP5S
W8LCR	ZGR5A
W8LCR	ZGR5A
W8LDCR	BUR6ET
W8LPR	ZGR5A
W8LTCR	BUR5ET
W95T30	BP4ES
W95T6	BP-4
W95TR6	BP-4
W9AC	B5HS
W9ACO	B5HS
W9C	B4ES
W9CC	B4ES
W9D	BP5ES
W9DC	BP5ES
W9DC0	BP5ES
W9DCX	BP5ES-11
W9DP	BP5ES
W9DPX	BP5ES-11



SPARK PLUG CONVERSION CHART

BOSCH TO NGK



 Bosch	 NGK
W9DTC	BP5ET
W9E	B-4
W9EC	B5S
W9ECO	B4-LM
W9EO	B4-LM
W9F	BP5S
W9FC	BP5S
W9LC	ZGR5A
WA125T30	BP5EFS
WA125T40	BP4FS
WA125TR30	BPR5EFS
WA125TR4	BR5FS
WA125TR40	BPR4FS
WA145T40	BPR5FS-15
WA145TR4	BPR5FS-15
WA145TR40	BPR5FS-15
WA175T30	BP6EFS
WA200T30	BP6EFS
WA200T40	BP6FS
WA200TR30	BPR6EFS
WA200TR40	BPR6FS
WA95T40	BP4FS
WA95TR4	BPR5FS-15
WA95TR40	BPR4FS
WAK145T3	BM6F
WAK225T3	BM7F
WAK225T30	BP7EFS
WAK225T6	BPM7A
WC2	B7ES
WEA	BUH
WEC	BUE
WET1	BUH
WET2	BUE
WG235T28	BP7ES
WG250P1	BPR9EIX
WG250T28	BPR8EIX
WG250T30	BP8ES
WG265T2SP	BPR9EIX
WKA125T3	BM6A
WKA145T6	BPM6A
WKA145TR6	BPMR6A
WKA175T3	BM6A
WKA175T6	BPM6A
WKA200TR6	BPMR6A
WKA225T3	BM7A

 Bosch	 NGK
WP9FP	BPR5S
WR10A	BR4HS
WR10AC	BR4HS
WR10BC	BPR4HS
WR10E	BR6S
WR10F	BP-4
WR10FC	BPR4S
WR10FCY	BPR4S-15
WR10FY	BP-4
WR10LC	ZGR5B
WR10LCV	BPR4ES-13
WR11EO	BR4-LM
WR11EO	BR4-LM
WR2CC	BR10ES
WR3CC	BR9ES
WR3CS	BR9EIX
WR3CTC	BR9ET
WR4AC	BR8HS
WR4AC	BR8HS
WR4CC	BR8ES
WR4CP	BR8EIX
WR4DPO	BKR7EIX
WR5A	BR7HS
WR5AC	BR7HS
WR5C	BR7ES
WR5CC	BR7ES
WR5CP	BR7ES
WR5D	BPR7ES
WR5DC	BPR7ES
WR5DC+	BPR7ES
WR5DP	BPR7ES
WR5DS	BPR7EIX
WR5D+	BPR7ES
WR6BC	BPR6HS
WR6D	BPR6ES
WR6DC	BPR6ES
WR6DCX	BPR6ES-11
WR6DC+	BPR6ES
WR6DPX	BPR6ES-11
WR6DS	BPR6EIX
WR6DTC	BUR6ET
WR78	BPR5ES
WR7A	BR6HS
WR7AC	BR6HS

 Bosch	 NGK
WR7B	BPR6HS
WR7BC	BPR6HS
WR7BC+	BPR6HS
WR7BP	BPR6HS
WR7B+	BPR6HS
WR7C	BR6ES
WR7CC	BR6ES
WR7CCX	BR6ES-11
WR7CP	BR6ES
WR7CPX	BR6ES-11
WR7D	BPR6ES
WR7DC	BPR6ES
WR7DC2	BPR6ES
WR7DCX	BPR6ES-11
WR7DCX+	BPR6ES-11
WR7DC+	BPR6ES
WR7DP	BPR6EIX
WR7DS	BPR6EIX
WR7DTC	BUR6ET
WR7D+	BPR6ES
WR7EC	BR6S
WR7F	BPR6S
WR7LTC+	BUR6ET
WR8AC	BR5HS
WR8BC	BPR5HS
WR8BC+	BPR5HS
WR8C	BR5ES
WR8CC	BR5ES
WR8CP	BR5ES
WR8D	BPR5ES
WR8DC	BPR5ES
WR8DC0	BPR5ES
WR8DC4	BPR5ES
WR8DCX	BPR5ES-11
WR8DCX+	BPR5ES-11
WR8DC+	BPR5ES
WR8DP	BPR5ES
WR8DPX	BPR5ES-11
WR8DPY	BPR5ES-15
WR8DS	BPR5EIX
WR8DS	BPR5EV
WR8D+	BPR5ES
WR8E	BR6S
WR8EC	BR6S
WR8EP	BR6S

 Bosch	 NGK
WR8F	BPR5S
WR8FC	BPR5S
WR8FP	BPR5S
WR8FPY	BPR5S-15
WR8HP	ZGR5C
WR8LC+	ZGR5A
WR8LTC+	BUR5ET-10
WR9A0	BR5HS
WR9C	BR5ES
WR9CC	BR5ES
WR9DC	BPR5ES
WR9DCX	BPR5ES-11
WR9DCX+	BPR5ES-11
WR9DCY	BPR5ES-15
WR9DC+	BPR5ES
WR9DP	BPR5ES
WR9DPX	BPR5ES-11
WR9DS	BPR5EIX
WR9DY	BPR5ES-15
WR9E	BR6S
WR9EO	BR6S
WR9ECO	BR6S
WR9F	BP5S
WR9FC	BPR5S
WR9FCY	BPR5S-15
WR9FPY	BPR5S-15
WR9FY	BPR5S-15
WR9H	ZGR5C
WR9HC	ZGR5C
WR9HP	ZGR5C
WR9LC	ZGR5A
WR9LE	ZGR5A
WR9LE	ZGR5A
WR9LS	ZGR5A
WS5F	BPMR7A
WS5E	BM7A
WS5F	BPM7A
WS6E	BM6A
WS6F	BPM6A
WS7E	BM6A
WS7F	BPM6A
WS8E	BM6A
WS8F	BPM6A
WS9EC	BM4A
WSR5F	BPMR7A



SPARK PLUG CONVERSION CHART

BOSCH TO **NGK**



Bosch

NGK

WSR6E	BMR6A
WSR6F	BPMR6A
WSR7F	BPMR6A
WSR8F	BPMR6A
WSR8F	BPMR6A
WSR9EC	BMR4A
X3CP0	D9EA
X4CS	D8EA
X5CC	D8EA
X5DC	D7EA
XR2AS	DR8HS
XR2CS	DR8ES
XR4AS	DR8HS
XR4CS	DR9EA
XR4DC	DR8EA
XR5DC	DR7EA
XR6CC	DR7EA
XR7LDC	DPR7EA-9
Y5DDC	PKR7A
Y5KPP332S	PZKER7A8EGS
Y6DC	DCPR6E
Y6NPP332	PLKR7B-8E
Y7LERO2	ZKER6A-10EG
Y7LPP332W	IZKR7B
Y7MPP33	PLKR6A
Y7MPP33	PLKR6A
YR5DDE	KR9CI
YR5DDE	KR9CI
YR5LDE	DCPR8EK
YR5NI332	LKAR9AI-9
YR6LDE	DCPR8EK
YR6NI332S	LKAR8AI-9
YR6NPP332	PLKR7B-8E
YR6TII330T	ILZKR7A
YR7DC	DCPR7E-N-10
YR7DC+	ZKR7A-10
YR7DE	DCPR8E-N
YR7LPP332W	IZKR7B
YR7MPP33	PLKR7A
YR7NE	LKR7B-9
YR8MEU	LKR6D-10E
YR8SEU	LZKR6B-10E
ZGR6STE2	ZKBR7A-HTU
ZMR5TPP33	SILZKBR8D8S
ZMR5TPP330	SILZKBR8D8S



Bosch

NGK

ZQR8SI302	PLZKBR7B8DG
ZR5SPP332	SILZKGR8D8S
ZR5SPP3320	SILZKGR8D8S
ZR5TPP33	SILZKBR8D8S
ZR5TPP33S	SILZKBR8D8S
ZR6SII3320	SILZKR7A-S
ZR7SI332S	SILZKBR8D8S



BRIGGS & STRATTON

NGK

ZR8TPP15	PFR7G-11
----------	----------



Brisk

NGK

D12YC	BCP7ES
D14Y	BCP7ES
D14YC	BCP7ES
D15YC	BCP6ES
D17Y	BCP5ES
D17YC	BCP5ES
DR12YC	BKR7E
DR14YC	BKR7E
DR14ZC	ZFR7F-11
DR14ZC1	BCPR7ES-11
DR15TC	BKUR5ET-10
DR15YC	BKR6ES
DR15Z	BKR6ES
DR15Z1	BKR6ES-11
DR17YC	BKR5ES
F14YC	AP7FS
F15YC	AP6FS
FR14YC	APR6FS
FR15YC	APR6FS
G12YC	BP7EFS
G14Y	BP7EFS
G14YC	BP7EFS
G15Y	BP6EFS
G15YC	BP6EFS
G17Y	BP5EFS
G17YC	BP5EFS
GR15YC	BPR6EFS
GR17YC	BPR5EFS
J17	B4-LM
J19	B2-LM
JR17	BR4-LM
JR19	BR2-LM
K15YC	BP6S
K17C	B6S
L10JW	B8EGV
L12Y	BP8ES
L12YC	BP8ES
L14Y	BP7ES
L14YC	BP7ES
L15Y	BP6ES
L15YC	BP6ES
L17Y	BP5ES
L17YC	BP5ES
L19	B4E
L08JW	B10EGV



SPARK PLUG CONVERSION CHART

CHAMPION TO NGK



Brisk	NGK
L08W	B11EGV
LR14TXS	BUR6ET
LR14YC	BPR7ES
LR14ZC	BPR7ES
LR14ZC1	BPR7ES-11
LR15TXS	BP6ET
LR15YC	BPR6ES
LR15Z	BPR6ES
LR15Z1	BPR6ES-11
LR17YC	BPR5ES
N14Y	BP6HS
N14Y	BP7HS
N14YC	BP7HS
N14YC	BP7HS
N15Y	BP6HS
N15YC	BP6HS
N17Y	BP5HS
N17Y	BP5HS
N17YC	BP5HS
N19	B5HS
N19C	B5HS
NR15YC	BPR6HS
P15Y	BPM7A
P17	BM6A
PR15Y	BPMR7A

Champion	NGK
PR17Y	BPMR6A
2071	FR4
860	A6FS
8815	D7EA
A10	D7EA
A57R	R2525-10
A59G	D9EV
A5YC	DP9EA-9
A6	D8EA
A61	D9EA
A61G	D9EV
A6Y	DP8EA-9
A6YC	DP8EA-9
A8	D7EA
A8Y	DP7EA-9
A8YC	DP7EA-9
BL11Y	BP5FS
BL13Y	BP5FS
BL4	B7FS
BL5	B7FS
BL6	B6FS
BL7Y	BP7FS
BL8	B6FS
BL9Y	BP6FS
BN12Y	BP5EFS
BN6Y	BP7EFS
BN89Y	BP6EFS
BN9Y	BP6EFS
C10YCC	BCP6ES
C281YC	BCP6ES
C53	R7234-10
C55	R7435-10
C57	R7436-9
C57A	R7436-10
C57C	R7436-9
C57CX	R7434-10
C57YC	R7435-9
C59	R7436-9
C59C	R7436-9
C59YC	R7435-9
C61	R7436-8
C6BYC	BCP7ET
C6YCC	BCP7ES
C7Y	BCP7ES
C7YC	BCP7ES

Champion	NGK
C7YCC	BCP7ES
C7YCX	BCP7ES
C9Y	BCP6ES
C9YC	BCP6ES
C9YCC	BCP6ES
C9YCX	BCP6ES
CCH9399	ILTR6E11
CJ11	BM6A
CJ3	BM7A
CJ6	BM7A
CJ6Y	BPM7A
CJ7Y	BPM7A
CJ8	BM6A
CJ8Y	BPM6A
D14	A-6
D16	AB-6
D16J	AB-6
D21	A-6
D23	AB-6
D6	A-8
D89D	AB-6
D9	A-6
D9J	A-6
DJ6J	BM7F
DJ7Y	BPM6F
DJ8J	BM6F
EON1	BKR6ES
EON2	BKR5ES
EON3	BPR5EFS
EON4	TR5A-10
EON5	BPR6ES
EON6	BPR5ES
EON9	LF5A-11
F-82	A-8F
F10	A6FS
F10C	A6FS
F11Y	AP5FS
F11YC	AP5FS
F14Y	AP5FS
F62Y	AP8FS
F7YC	AP7FS
F7YCC	AP7FS
F81Y	AP8FS
F83Y	AP8FS
F9Y	AP6FS

Champion	NGK
F9YC	AP6FS
G1	C9E
G2	C8E
G52V	R0045Q-11
G55	C9E
G58	C9E
G59C	CR8E
G61	C8E
G63	C8E
H03	B6S
H10	B-6L
H10C	B6L
H10J	B-6L
H11	B-4L
H12	B-4L
H14Y	B6L
H8J	B-6L
J10Y	BP6S
J11	B-4
J11J	B-4
J11J	B-4
J11Y	BP5S
J12J	B-2
J12Y	BP5S
J12YC	BP5S
J12YC	BP5S
J13Y	BP5S
J14Y	BP5S
J14YC	BP5S
J17LM	B4-LM
J18YC	BP-4
J19LM	B2-LM
J2J	B9S
J4C	B7S
J4J	B7S
J6	B6S
J6C	B6S
J6J	B6S
J7	B6S
J7J	B6S
J8C	B6S
K-8	A-8
K15J	A-6
K2G	A9V
K3G	A8V



SPARK PLUG CONVERSION CHART

CHAMPION TO NGK



Champion NGK

K5G	A8V
K8G	A8V
K9	A-7
KC8ZPYPB4	PZFR5D-11
KEC4PYPBF	SILFER8C7ES
KEC6PYPB-1	PLFER7A-8EG
L10	B6HS
L12Y	BP5HS
L14	B-4H
L15Y	BP4HS
L19V	BUH
L288	B5HS
L3G	B8HV
L4G	B7HV
L4J	B7HS
L5	B7HS
L55G	B10HV
L61Y	BP8HS
L64Y	BP7HS
L66Y	BP6HS
L6G	B7HV
L76V	BUHW
L77J	B9HS
L77J4	B9HS-10
L77JC4	B7HS-10
L77V	BUHW
L78	B8HS
L78C	B8HS
L78V	BUHW-2
L7J	B6HS
L81	B7HS
L81Y	BP7HS
L82	B6HS
L82C	B6HS
L82Y	BP7HS
L82YC	BP6HS
L82YCC	BP7HS
L85	B6HS
L86	B6HS
L86C	B6HS
L86CC	B6HS
L87Y	BP6HS
L87YC	BP6HS
L87YCC	BP6HS
L88A	B5HS



Champion NGK

L89CM	BP5HS
L92Y	BP5HS
L92YC	BP5HS
L95Y	BP4HS
L9J	B6HS
N1	B10ES
N10PY	BP6EV
N10Y	BP6ES
N10Y4	BP6ES-11
N11Y	BP5ES
N11YC4	BP5ES-11
N11YCC	BP5ES
N12Y	BP5ES
N12YC	BP5ES
N12YCC	BP5ES
N13L	ZGR5C
N13Y	BP5ES
N14Y	BP5ES
N16Y	BP4ES
N16YC	BP4ES
N178B	B8EM
N180B	B7EM
N19V	BUE
N2	B9ES
N21	B4ES
N21	B4ES
N279YC	BP7ES
N281YC	BP6ES
N288	B5ES
N2C	B9ES
N2G	B9EV
N3C	B8ES
N3G	B8EV
N4	B7ES
N4C	B7ES
N4G	B7EV
N4YC	BP9ES
N5	B6ES
N54R	B10EG
N57	B10ES
N57G	B105EGV
N57R	B10EG
N59G	B95EGV
N5C	B6ES
N5G	B6EV



Champion NGK

N6	B6ES
N60	B9ES
N60R	B8EG
N60Y	BP10ES
N62R	B8EG
N63Y	BP9ES
N64Y	BP8ES
N65Y	BP7ES
N66Y	BP6ES
N6Y	BP8ES
N6YC	BP8ES
N6YCC	BP8ES
N7	B7ES
N74C	B6EB-11
N79Y	BP6ES
N7BYC	BP6ET
N7BYC	BUR6ET
N7GY	BP7EV
N7Y	BP7ES
N7YC	BP7ES
N7YCC	BP7ES
N7YCX	BP7ES
N8	B6ES
N80	B10EG
N80G	B11EGV
N82	B10EG
N82G	B105EGV
N84	B9EG
N84G	B95EGV
N86	B9EG
N86G	B9EGV
N87	B8EG
N87G	B8EGV
N8GY	BP6EV
N8L	ZGR5C
N8Y	BP6ES
N9BMC	BPR5EKU
N9BYC	BP6ET
N9Y	BP6ES
N9YC	BP6ES
N9YC4	BP6ES-11
N9YCC	BP6ES
N9YCX	BP6ES
OBL9Y	BPR6FS
OE001	BP6ES



Champion NGK

OE002	BKR6E
OE003	BCP6ES
OE004	BPR6ES
OE005	BKR6ES
OE006	BPR6ES
OE007	BP6HS
OE008	BPR7ES
OE009	BP7EFS
OE010	BP7ES
OE011	BPR6EFS
OE012	BP6ET
OE013	BKR5ES
OE014	BCPR7ES
OE015	BP5ES
OE016	BKR6ES
OE017	BCP7ES
OE018	BPR7ES
OE019	BKR5EK
OE020	BPR6EFS
OE021	BCPR6ET
OE022	BP6ES
OE023	BCP6ES
OE025	BUR6ET
OE026	BKR6EK
OE027	BUR5ET-10
OE028	BP5ET-10
OE030	BKR6EKC
OE031	PTR5A-13
OE032	BKUR6ET-10
OE033	BKR6EZ
OE034	BKR6EZ
OE035	LFR5B
OE036	BP7EFS
OE038	BP6HS
OE039	BKR6ES-11
OE041	ZFR5F-11
OE042	BPR5ES
OE043	BCPR7ES
OE044	BP6ET
OE045	BPR5ES
OE046	BP7ES
OE048	BPR6ES-11
OE049	BPR5ES-11
OE050	BP7EFS
OE051	BPR5ES



SPARK PLUG CONVERSION CHART

CHAMPION TO NGK



Champion NGK

OE054	APR6FS
OE055	BP5ES
OE056	BKR7ES-11
OE057	BCP5ES
OE058	BCP7ES
OE059	BP5HS
OE060	ZGR5B
OE061	AP7FS
OE063	BKR6ES-11
OE064	BPR6HS
OE065	BP5ES
OE067	BP7EFS
OE070	BP6HS
OE072	BPR5EFS
OE073	DCPR9E
OE075	BCP7ES
OE076	BCP6ET
OE077	BCPR6ET
OE080	BKR7ES-11
OE083	DCPR8E
OE084	BP8ES
OE085	BKR5EKU
OE087	BP8ES
OE090	BP7EFS
OE093	BKR5EZ
OE095	BP6ET
OE099	BPR5EFS
OE100	BKR5EKU
OE103	DCPR9EVX
OE104	BP6HS
OE105	GR4
OE106	BP5ES
OE109	BP6ET
OE110	BCPR7ES
OE122	PMR7A
OE124	PFR5J-11
OE129	BKR7EVX-11
OE130	LZKAR7A
OE131	PTR5D-10
OE134	PFR5J-11
OE135	LFR4AP-11
OE136	PFR6J-11
OE141	BKR6EVX
OE143	PFR6G-9
OE144	BKUR6ET-10



Champion NGK

OE145	BKUR6ET-10
OE146	PFR5G-13E
OE151	BPR5EFS
OE152	BKR5E-11
OE155	APR6FS
OE156	ZGR5C
OE160	ZFR4F-11
OE161	GR4
OE162	BR6ES
OE163	LZTR4A-11
OE165	R7436-9
OE169	R5724-9
OE171	BPR6FS
OE173	R2525-10
OE175	LF5AP-11
OE178	LF5B
OE197	PLKR7A
OE245	SILZKGR8B8S
OJ11Y	BPR6S
OJ12Y	BPR5S
OJ13Y	BPR5S
ON11Y	BPR5ES
ON12Y	BPR5ES
ON3	BR8ES
P10Y	D6HA
P7G	D8HV
P8G	D6HV
P8Y	D6HA
PG2PHP	PMR8A
PG4PHP	PMR7A
PG4PHP	PMR7A
PG4PHP	PMR7A
PRZ9HC	CR7HSA
QC10PEP	PZFR6H
QC10WEP	PZFR6H
QC12PEP	PZFR6H
QC12PEP	PZFR6H
QC12PEPB	IZFR6N-E
QC12YC	BKR5E
QC59	BCR8ES
QC59C	BCR8ES
QC8WEP	PZFR6H
QJ19LM	BR2-LM
QL16V	BUZ8H
QL76V	BUHZW



Champion NGK

QL77CC	BR8HS
QL77J4	BR9HS-10
QL77JC4	BZ7HS-10
QL78C	BZ7HS-10
QL78V	BUZHW-2
QL78YC	BPR7HS
QL7J5	BR6HS
QL81Y	BPR7HS
QL82AC	B8HS-10
QL82C	BR6HS
QL82YC	BPR7HS
QL86	BR6HS
QL87YC	BPR6HS
QN2	BR9ES
QN2C	BR9ES
QN2G	BR9EV
QN86	BR8EG
R10	D6EA
R6	D8EA
R6G	D8EV
R8	D7EA
RA2HC	DPR9EA-9
RA4HC	DCPR9E
RA4HCC	DCPR8E
RA59GC	DCR9EIX
RA6Y	DPR8EA-9
RA6YC	DPR8EA-9
RA7YC	DCPR8E
RA8HC	DCPR7E
RAX92DC	JR9C
RAX92YC	DPR9EA-9
RAX94C	DR8EA
RAX94YC	DPR8EA-9
RAX96C	DR7EA
RAX96YC	DPR7EA-9
RBL11Y	BPR5FS
RBL11Y6	BPR5FS-15
RBL12-6	BPR5FS-15
RBL13Y	BPR5FS
RBL13Y6	BPR5FS-15
RBL15Y	BPR4FS
RBL15Y4	BPR4FS-11
RBL16Y	BPR4FS
RBL17Y	BPR4FS
RBL8	BR6FS



Champion NGK

RBL8-6	BR6FS-15
RBN12Y	BPR5EFS
RBN13Y	BPR5EFS
RBN14Y	BPR5EFS
RBN9Y	BPR6EFS
RC10DMC	BKR5EK
RC10MCC	ZFR5F-11
RC10PYP4	PFR5J-11
RC10PYPB4	PFR5G-11
RC10WYP4	IFR5N-10
RC10YC	BCPR6ES
RC10YC4	BKR6E-11
RC11LCC4	BRE527Y-11
RC11PYPB4	PFR6N-11
RC12ECC	ZFR5N
RC12LYC	FR5-11
RC12MC4	PZFR5F-11
RC12MC5	ZFR5F-11
RC12MCC4	ZFR5F-11
RC12MCC4	ZFR5F-11
RC12YC	BCPR5ES
RC12YC	BKR5ES
RC12YC5	FR45
RC12YCC	BKR5E
RC12YCC4	BKR5E-11
RC14PLP5	PLZTR5A-13
RC14YC	BKR5ES
RC6YC	BCPR7ES
RC78PYP	PFR7G-11
RC7BMC	BCPR6ET
RC7BYC4	BCPR6ET
RC7QMC	BKR7EQUP
RC7Y	BCPR7ES
RC7YC	BCPR7ES
RC7YC4	BKR7E-11
RC7YCC	BCPR7ES
RC7YCL	BKR6EZ
RC87LYC	BKR6E
RC87YCL	BKR6EZ
RC89TMC	BKUR5ET-10
RC89YCC	BKR6ES
RC8DMC	BKR6EK
RC8DMC	BKR6EK
RC8PYCB	PFR6G-11
RC8PYP	PFR6J-11



SPARK PLUG CONVERSION CHART

CHAMPION TO NGK



Champion NGK

RC8PYPB4	PFR6N-11
RC8VTYC4	BKUR6ET-10
RC8YC	BKR6E
RC8YC4	BKR6E-11
RC8YCL	BKR6EZ
RC9BMC	BKR5EKU
RC9MC4	ZFR5F-11
RC9MCC	ZFR6F-11
RC9MCC4	ZFR6F-11
RC9YC	BCPR6ES
RC9YC4	BCPR6ES-11
RC9YCC	BCPR6ES
RC9YCC4	BCPR6ES-11
RCJ6	BMR7A
RCJ6Y	BPMR7A
RCJ7Y	BPMR7A
RCJ7Y	BPMR7A
RCJ8	BMR6A
RD14	AR-6
RD16	AR-6
RD16J	AR-6
RD9	AR-6
RDJ6J	BMR7F
RDJ7J	BMR6F
RDJ7Y	BPMR6F
RE10LC	TR5
RE14MCC4	LZTR4A-11
RE14MCC5	LZTR4A-11
RE14MCC5	LZTR4A-11
RE14PLP5	LZTR5AIX-13
RE16MC	LZTR4A-11
RE7PYC5	PTR5A-13
RE7YCC	PTR5A-13
RE8MX	LZKAR7B
REA12MC4	LZKAR6C-11
REA12WMD4	LZKAR6AP-11
REA8MCL	LZKAR7A
REA8WYPB4	ILKAR7B-11
REC10PYC4	LFR5AP-11
REC10PYC4	LFR5AP-11
REC10WYPB4	ILFR6B
REC10YC4	LFR5A-11
REC9MCLX	LFR5B
REC9YCL	LFR5B
RER8MC	LZKR6B-10E
RER8WYPB4	PLKR7A



Champion NGK

RER8YC	LKR6D-10E
RER8YC	LKR6D-10E
RER8ZWYCB4	ILKR7B-8
RER8ZWYCB4	ILZKR7B-11
RES9PYP4	PTR5A-10
RES9YCC4	PTR5A-10
RES9YCC4	TR5B-13
RF10	AR6FS
RF10C	AR6FS
RF11Y	APR6FS
RF11YC	APR6FS
RF12	AR5FS
RF12-5	AR5FS-11
RF14Y	APR5FS
RF7YC	APR6FS
RF9Y5	APR6FS-11
RF9YC	APR6FS
RFN14LY	ZF4A-11
RG4HC	CR9EB
RG4PHP	PMR7A
RG6HCC	CPR8EA-9
RG6HCC	CPR8EA-9
RG6YC	CPR8E
RG6YCH	CPR8E
RG94C	CR8EH-9
RGU92C	CR9EH-9
RH10C	B6L
RH18Y	B4L
RJ10Y	BPR6S
RJ11	BR6S
RJ11Y	BPR5S
RJ12C	BR6S
RJ12Y	BPR5S
RJ12Y6	BPR5S-15
RJ12YC	BPR5S
RJ12YC6	BPR5S-15
RJ14Y	BPR5S
RJ14YC	BPR5S
RJ18Y	BPR4S
RJ18Y6	BPR4S-15
RJ18YC	BPR4S
RJ18YC6	BPR4S-15
RJ19LM	B4LM
RJ20Y	BPR4S
RJ6	BR6S
RJ6C	BR6S



Champion NGK

RJ6J	BR6S
RJ7	BR6S
RJ8	BR6S
RJ8C	BR6S
RJ8J	BR6S
RL12Y	BPR6HS
RL19	BR5HS
RL4J	BR7HS
RL77J	BR9HS
RL78	BR8HS
RL78C	BR8HS
RL7J	BR6HS
RL82	BR6HS
RL82C	BR6HS
RL82Y	BPR7HS
RL82YC	BPR6HS
RL85	BR6HS
RL86	BR6HS
RL86C	BR6HS
RL87Y	BPR6HS
RL87YC	BPR6HS
RL87YC	BPR6HS
RL95YC	BPR5HS
RL95YC	BPR6HS
RN10GY	BPR6EV
RN10Y	BPR6ES
RN10Y4	BPR6ES-11
RN11Y	BPR5ES
RN11YC	BPR5ES
RN11YC4	BPR5ES-11
RN11YCC	BPR5ES
RN12GY	BPR5EV
RN12Y	BPR5ES
RN12YC	BPR5ES
RN12YC4	BPR5ES-11
RN12YCC	BPR5ES
RN14LY	ZGR5C
RN14PMP5	BPR5EP-11
RN14Y	BPR5ES
RN14Y6	BPR5ES-15
RN16Y	BPR4ES
RN2	BR9ES
RN2C	BR9ES
RN2G	BR9EV
RN4	BR7ES
RN4C	BR7ES



Champion NGK

RN5	BR6ES
RN6	BR6ES
RN6Y	BPR8ES
RN6YC	BPR8ES
RN74C	BR6EB-11
RN7GY	BPR7EV
RN7Y	BPR7ES
RN7YC	BPR7ES
RN7YCC	BPR7ES
RN8	BR5ES
RN8L	ZGR5C
RN8VTYC4	BUR6ET
RN9BMC	BPR5EKU
RN9GY	BPR6EV
RN9LCC	ZGR5B
RN9Y	BPR6ES
RN9YC	BPR6ES
RN9YC4	BPR6ES-11
RN9YCC	BPR6ES
RN9YCC4	BPR6ES-11
RP7	DR8HS
RS10LC	TR5-1
RS12PYP	TR55IX
RS12YC	BPR5EFS
RS12YC6	BPR5EFS
RS13LYC	TR4-2
RS14PYP	TR4IX
RS14YC	BPR5EFS
RS14YC	BPR5EFS
RS14YC6	BPR5EFS-13
RS5C	BR7EFS
RS7YC	BPR7EFS
RS9PYP4	PTR5D-10
RS9YC	BPR6EFS
RS9YCC	BPR6EFS
RV12C6	BR5FS-15
RV12YC	BPR5FS
RV12YC6	BPR5FS-15
RV15YC	BPR4FS
RV15YC4	BPR4FS-11
RV15YC6	BPR4FS-15
RV17YC	BPR4FS
RV8C	BR6FS
RV8C6	BR6FS-15
RV9YC	BPR6FS
RY4C	CMR6A



SPARK PLUG CONVERSION CHART

DENSO TO NGK



Champion NGK

RZ7C	CMR7H
RZ96C	CR7HSA
RZN12Y5	BPR5EFS
S12YC	BP5EFS
S279YC	BP6EFS
S281YC	BP6EFS
S379YC	BP7EFS
S7YC	BP7EFS
S9YC	BP6EFS
TE10PMC5	ILTR6A-13G
UD16	A-6
UJ12	B-2
UJ2J	B8S
UJ4J	B7S
UJ6	B6S
UJ8	B6S
UJ81C	B7S
UK10	AB-6
UL4J	B7HS
UL77V	BUHXW-1
UL81C	B7HS
UL81J	B7HS
UN79Y	BP6ES
V12YC	BP5FS
V4C	B7FS
V59C	R5673-9
V9YC	BP6FS
W14	G-2Z
W14FC	AP6FS
WR9LCX+	ZGR5C
XC12PEPB	PZFR6H
XC92PYC	BKR5EP-11
XC92YC	BKR5E
Y8	CMR6A
Y82	CM-6
Z10	C6HSA
Z10G	C7HV
Z12	C6HSA
Z6	C8HSA



Denso NGK

3004	BPR5EP-11
3005	BCPR5EIX-11
3006	BCPR5EY-11
3009	BCPR6EY-11
3011	BP4EY
3013	BPR4EY
3018	BP5ES
3018	BP5ES
3027	BP5EY
3032	BPR5EY-11
3034	B5HS
3043	BP6ES
3046	BUR6EA-11
3049	BPR6ES-11
3057	BR6ES
3062	BP6EY
3066	BPR6EY
3067	BPR6EY-11
3068	BP6HS
3070	BPR6HS
3085	BP7ES
3088	BPR7ES
3089	BPR7ES-11
3103	BR8ET
3107	BR9ET
3110	BR5ES
3111	SD11A
3112	ZFR6A-11
3113	BCPR6EP-N-8
3114	PGR5A-11
3115	PGR6A-11
3117	BCPR6EP-11
3119	BKR5EYA
3120	BKR5EYA-11
3121	BKR6E-11
3122	BKR6EYA
3123	BCPR5EP-8
3125	BCP6ES
3127	BKR6EP-8
3128	BKR6EP-11
3129	BCPR5EY
3130	BKR5E-11
3131	ZFR5J-11
3132	ZFR5F-11
3133	ZFR6J-11
3134	BKR5EP-11



Denso NGK

3135	ZFR5E-11
3139	BKR6EY-11
3140	BCPR6EY
3141	PFR6J-11
3142	PFR6G-11
3144	BKR6E-N-11
3156	BCPR5EIX-11
3157	BCPR6EVX-11
3158	BCP7EVX
3161	BKR5EVX-11
3163	BKR6EVX-11
3165	BKR7E
3167	ZFR4F-11
3168	PFR6B-11
3169	ZFR6F-11
3172	PFR6G-13
3174	PFR5J-11
3175	PZFR5F
3179	DCPR7E
3184	BCPR5EY-11
3186	BCPR5EY-11
3187	BCPR6EY-11
3192	BKR7E-11
3194	BKR5EKB-11
3195	BKR6EKB-11
3196	BKUR6EK
3197	BKUR7EK
3199	BP5EY-11
3201	BPR5ES-11
3210	BPR5EY
3213	BPR5ES-13
3226	BKR6EP-13
3231	BPR5EIX
3235	BCRE527Y
3239	BPR5EP-13
3242	DCPR7EVX
3244	BCPR6EIX-11
3245	PFR6J
3246	PZFR5F-11
3247	PZFR6F-11
3253	BKR6EKP-11
3255	BCP7ES
3256	ZGR5A
3262	BKR6EVX-11
3264	PFR5B-11
3273	PFR7B



Denso NGK

3275	PFR5G-11
3277	BPR6EKN
3281	BPR7EIX
3285	BPR5EIX-11
3289	BKR5EKP-11
3290	BKR7EVX
3291	BPR6EVX
3293	BKR5EVX
3297	IFR6T-11
3299	BKR7E-N-11
3302	PGR7A
3303	IFR5T-8N
3304	BKR6EKC
3305	BKUR6EK-9
3306	PGR6A
3307	IFR6C
3310	BR10ET
3312	DCPR8E
3313	DCPR9E
3314	DCPR9EVX
3323	BPR6EVX-11
3333	BKR6E
3344	BPR6ES
3345	BPR5ES
3346	BCPR5E
3347	BCPR7ES
3348	ZFR7F-11
3349	BKR5E
3353	BKR5EIX-11P
3354	IGR7A
3372	IFRTG-11KS
3373	BKR6EP-8
3374	ZFR6K-11
3377	IZFR6K-11
3378	ZFR6FIX-11
3379	BCPR7ES-11
3380	BKR6EKPA
3381	IFR6C-11
3396	IZFR5F-11
3400	IFR5E-11
3403	IFR6B-K
3412	IFR5E-11
3413	ZFR5F
3418	IFR6E-11
3424	BKR6E
3427	LZKAR7A



SPARK PLUG CONVERSION CHART

DENSO TO **NGK**



 Denso	 NGK	 Denso	 NGK	 Denso	 NGK	 Denso	 NGK
3432	IZFR6K-11S	5343	LF5AIX-11	IK16	BKR5EIX-11	IW22	BPR7EIX
3434	IKR7C	5344	LF6AIX-11	IK20	BKR6EIX-11	IW24	BR8EIX
3439	DILKAR6A-11	5378	BPR6HIX	IK22	BKR6EIX	IW27	BR9EIX
3441	ILKR7B-8	5601	BCPR5EIX-11P	IK24	BKR8EIX	IW31	BR10EIX
3444	ILKAR7B-11	5602	BCPR6EIX-11P	IK24C11	FR8BI-11	IWF22	BR7HIX
3449	IFR6J-11	5603	BKR6EIX-11P	IK27	BKR9EIX	IWF24	BR8HIX
4019	BP5HS	5604	IZFR6H-11	IK27C	FR9BI-11	IX22B	DPR7EIX-9
4021	BP7HS	5617	ILZFR5B	IK31	R7436-10	IX24	DR8EIX
4028	BP8ES	5618	ILZFR6D-11	IKBH20TT	DFH6B-11A	IX24B	DPR8EIX-9
4032	B8EGV	5623	HB6AIX-11P	IKH16	LF5AIX-11	IX27	DR9EIX
4048	B9EGV	5625	HB6BIX-11P	IKH20	LF6AIX-11	IX27B	DPR9EIX-9
4057	B95EGV	D1	BUR6ET	IKH20TT	DILFR6A-11	IXEH20TT	ILKAR7K11S
5008	APR5FS	D10	BPR6EY-11	IKH22	ILFR7H	IXEH22TT	ILKAR7K11S
5012	AP6FS	D11	BCPR6EY-11	IKH0124	R7438-8	IXU22	DCPR7EIX
5013	APR6FS	D12	BKR6E	IK0124	R7434-8	IXU22C	DCPR7EIX
5013	BP6EFS	D13	BPR6ES-11	IK0127	R7434-9	IXU22I	IKR7D
5022	BPR5EFS	D14	BKR6E-11	IK0131	R7434-10	IXU24	IRIMAC8
5027	BPR5FS-15	D15	ZGR5A	IK0224	R7434-8	IXU27	IKR9J8
5032	BPR6EFS	D17	BCP6ES	IK0227	R7434-9	J16A-U11	BE527Y-11
5035	BPR6FS	D18	BP6HS	IK0231	R7434-10	J16AR-U11	BRE527Y-11
5040	BP7EFS	D19	BPR7ES	IQ16	BCPR5EIX-11	J16AY	BP5EJ
5060	BKUR6ET	D2	BPR6ES	IQ20	BCPR6EIX-11	J16AYR	BPR5EJ
5061	BKUR6ET-10	D20	BKR6EKUB	IQ22	IRITOP7	J16B-U11	BE529Y-11
5062	BKUR7ET	D21	BKR5E-11	IQ24	IRITOP8	J16BR-U	BRE529Y
5063	BKR6EKUB	D3	BPR6HS	IQ27	IRITOP9	J16C-U	BPR5EY
5064	BP5RT-10	D4	BP6ES	IT16	TR5IX	J20AY	BPR6EY-11
5065	BP6ET	D5	BP6EFS	IT20	TR6IX	K14PR-U11	BKR4E-11
5066	BP7ET	D6	BPR5ES	IT22	TR7IX	K14PU11	BKR5E-11
5067	BUR6ET	D7	BPR6EFS	IT24	TR8IX	K16-U	BKR5EYA
5068	PTR5A-10	D8	BP5ES	ITF16	UR5IX	K16-U11	BKR5EYA-11
5069	BCP7ET	D9	BPR5EY	ITF20	UR6IX	K16GPR-U11	ZFR5E-11
5070	PTR5D-10	DXE22HCR11S	DILZKAR7C-11S	ITL16	LZTR5AIX-13	K16GPRU11	ZFR5E-11
5077	PZTR5A-15	DXU22HCR-D11S	DILZKR7B-11GS	ITV16	LTR5IX-11	K16HPR-U11	LF6A-11
5301	BCPR5EIX-11	FK20HBR-11	DFH6B-11A	ITV16TT	ILTR5K-13	K16HR-11	LF5C-11
5302	BCPR6EIX-11	FK20HBR11	DFH6B-11A	ITV20TT	ILTR6E11	K16HRU11	LF5C-11
5303	BKR5EIX-11	FK20HR11	DILFR6A-11	ITV22	LTR7IX-11	K16P-U	BK5E
5304	BKR6EIX-11	FK20HR11	ILFR6D-11	IU22	CR7EIX	K16PR-L11	BKR5EN-11
5305	BPR5EIX-11	FK28BR11	DFH6B-11A	IU24	CR8EIX	K16PR-P11	BKR5EVX-11
5306	BPR6EIX-11	FXE20HE11	DF7H-11B	IU27	CR9EIX	K16PR-TP11	BKR5EVX-11
5307	BPR7EIX	FXE20HR11	DILKAR6A-11	IU27D	CR9EIA-9	K16PR-U	BKR5E
5308	DCPR7EIX	FXE22HR11	DF7H-11B	IUF22	CR7HIX	K16PR-U11	BKR5E-11
5325	TR5IX	FXE24HR11	DF8H-11B	IUF24	CR8HIX	K16PR-ZU11	BKR5EVX-11
5327	TR7IX	IAE0132	R7282-105	IUH24	CR8EHIX-9	K16PRL11	BKR5E-N-11
5328	TR8IX	IAE0134	R7282-11	IUH27	CR9EHIX-9	K16R-U	BKR5EYA
5330	UR5IX	IA0132	R7282A-105	IW16	BPR5EIX-11	K16R-U11	BKR5EYA-11
5331	UR6IX	IA0134	R7282A-11	IW20	BPR6EIX-11	K16TNRS9	BKR5EKU



SPARK PLUG CONVERSION CHART

DENSO TO NGK



 Denso	 NGK
K16TR11	BKR5EKB-11
K16TT	ZFR5F-11
K20-U	BKR6EYA
K20-U11	BKR6EYA-11
K20DTR-S11	ZFR6G
K20HR-U11	LF6C-11
K20P-U	BK6E
K20PBR	BKUR6ET
K20PBR-S10	BKUR6ET-10
K20PR-L11	BKR6EN-11
K20PR-L11	BKR6EN-11
K20PR-TP11	BKR6EVX-11
K20PR-U	BKR6E
K20PR-U11	BKR6E-11
K20PR-ZU11	BKR6EVX-11
K20R-U	BKR6EYA
K20R-U11	BKR6EYA-11
K20R-Z	BKR6EVX
K20R-ZU11	BKR6EVX-11
K20TMR11	BKR6EKC-N-11
K20TNR	BKR6EKC
K20TNR-S	BKUR6EK
K20TNR-S9	BKUR6EK-9
K20TR11	BKR6EKB-11
K20TT	ZFR6T-11G
K20TXR	BKR6EKUB
K22P-U11	BK7E-11
K22P11	BK7EK-N-11
K22PB	BKUR7ET
K22PBR-S	BKUR7ET
K22PR-L11	BKR7E-N-11
K22PR-TP11	BKR7EVX-11
K22PR-U	BKR7E
K22PR-U11	BKR7E-11
K22PR-ZU	BKR7EVX
K22TM11	BK7EK-N-11
K22TMR	BKR7EKC-N
K22TMR11	BKR7EKC-N-11
K22TNR	BKR7EKC
K22TNR-S	BKUR7EK
K24PR-U11	BKR8E-11
KH16TT	LF6A-11
KH20TT	LF6C-11
KJ14CR-L11	ZFR4F-11
KJ14CR11	ZFR4F-11
KJ16CR	ZFR5F

 Denso	 NGK
KJ16CR-L11	ZFR5F-11
KJ16CR-L11	ZFR5J-11
KJ16CR-ULL	ZFR5F-11
KJ16CR11	ZFR5J-11
KJ20CR-L11	ZFR6F-11
KJ20CR-L11	ZFR6J-11
KJ20CR-L11	ZFR6U-9
KJ20CR-U11	ZFR6F-11
KJ20CR11	ZFR6J-11
KJ20DR-M11	ZFR6K-11
KJ22CR-L11	ZFR7F-11
KJ22CR-L8	ZFR7F
KJ22CR11	ZFR7F-11
L14-U	AB-6
LP20-U	BP6EY
LP20R-U	BPR6EY
M17	A-6
M22	A-7
M24S	A-8
MA14P-U	AP4FS
MA16P-U	AP5FS
MA16PR-U	APR5FS
MA17P-U	AP6FS
MA20P-U	AP6FS
MA20PR-U	APR6FS
MA20R-U	AR6FS
MW17	AB-6
MW22	AB-7
MW9	AB-2
P16PR11	PGR5A-11
P16PR8	PGR5A
P16R	BPR5EP-11
P16R13	BPR5EP-13
P20PR11	PGR6A-11
P20R11	BPR6EP-11
P20R8	BPR6EP-8
P22PR8	PGR7A
PK16PR-L11	PFR5G-11
PK16PR-P11	PFR5J-11
PK16PR11	PFR5B-11
PK16R11	BKR5EP-11
PK16R8	BKR6EP-8
PK16TR11	BKR5EKP-11
PK16TR13	BKR5EKP-13
PK20GR8	BKR6EPA-8
PK20PR-L11	PFR6G-11

 Denso	 NGK
PK20PR-L11	PFR6G-11
PK20PR-L13	PFR6G-13
PK20PR-P	PFR6J
PK20PR-P11	PFR6J-11
PK20PR-P8	PFR6J
PK20PR-TP	PFR6M
PK20PR11	PFR6B-11
PK20R-P8	BKR6EP-N-8
PK20R11	BKR6EP-11
PK20R13	BKR6EP-13
PK20R8	BKR6EP-8
PK20TR11	BKR6EKP-11
PK20TT	PZFR6H
PK22PR-L11	PFR7G-11
PK22PR-TP	PFR7M
PK22PR11	PFR7B-11
PK22PR8	PFR7B
PKJ16CR-L11	PZFR5F-11
PKJ16CR-L13	PZFR5F-13
PKJ16CR8	PZFR5F
PKJ20CR-L11	PZFR6F-11
PKJ20CR8	PZFR6F
PQ16R	BCPR5EP-11
PQ16R13	BCPR5EP-13
PQ16R8	BCPR5EP-8
PQ20R	BCPR6EP-11
PQ20R-P11	BCPR6EP-N-11
PQ20R-P8	BCPR6EP-N-8
PQ20R13	BCPR6EP-13
PQ20R8	BCPR6EP-8
PT16EPR-C13	PTR5C-13
PT16EPR-L13	PTR5C-13
PT16VR13	PTR5A-13
PT16VR13	PTR5A-13
PTJ16R15	PZTR5A-13
Q14R-U11	BCPR4EY-11
Q16-U	BCP5E
Q16-U11	BCP5EY
Q16-ZU11	BCP5EVX-11
Q16P-U11	BCP5E-11
Q16PR-TP11	BCPR5EVX-11
Q16PR-U	BCPR5E
Q16PR-U11	BCPR5E-11
Q16PR-ZU11	BCPR5EVX-11
Q16R-U	BCPR5EY
Q16R-U11	BCPR5EY-11

 Denso	 NGK
Q16R-ZU11	BCPR5EVX-11
Q20-U11	BCP6E-11
Q20-ZU11	BCP6E-11
Q20P-U	BCP6E
Q20P-U11	BCP6E-11
Q20PR-P11	BCPR6EVX-11
Q20PR-U	BCPR6E
Q20PR-U11	BCPR6EY-11
Q20PR-ZU11	BCPR6EVX-11
Q20R-U	BCPR6EY
Q20R-U11	BCPR6EY
Q20R-ZU11	BCPR6EVX-11
Q20TT	BKR6E
Q20U	BCP6E
Q22P-U	BCP7E
Q22P-U11	BCP7E-11
Q22PR-P11	BCPR7EVX-11
Q22PR-U	BCPR7E
Q22PR-U11	BCPR7E-11
Q22PR-ZU	BCP7EVX
Q22PR-ZU11	BCPR7EVX-11
QJ16AR-U	BCRE527Y
QJ16AR-U11	BCRE527Y-11
QJ16C11	ZFR5A-11
QJ16CR11	ZFR5A-11
QJ20C11	ZF6A-11
QJ20CR11	ZFR6A-11
QJ22CR11	ZFR7A-11
QL20PR-U	BCPR6ED
QL20TR-S	BCPR6EKD
QL22TR-S	BCPR7EKD
S-27	SD9A
S-29	SD10A
S-29A	SD10A
S-31A	SD11A
S22PR-A7	IGR7A
SC16HR11	ILKAR7B-11
SC20HR11	ILKAR7B-11
SF-10	BUHX
SF-24	BU8H
SF-50	BUHW
SF-51	BUHW-2
SK16HR-11	ILFR6C-11
SK16PR-A11	IFR5E-11
SK16PR-E11	BKR5EIX-11P
SK16PR-L11	IFR5G-11K



SPARK PLUG CONVERSION CHART

DENSO TO **NGK**



Denso	NGK	Denso	NGK	Denso	NGK	Denso	NGK
SK16R-11	IFR5T-11	U16FS-L	C5HSA	U27ESR-N	CR9E	VQ16	BCPR5EIX-11P
SK16R11	IFR5D-10	U16FS-U	C5HSA	U27ESR-NB	CR9EB	VQ20	BCPR6EIX-11P
SK20BR-11	HB6BIX-11P	U16FS-UB	C5HSB	U27ESR-NZU	CR9EVX	VT20	ITR6F-13
SK20HR11	ILFR6T-11	U16FSR-L	CR5HSA	U27ETR	CR9EK	VUH24Z	IMR8A-9H
SK20HR11	LFR6C-11	U16FSR-U	CR5HSA	U27FE-ZU9	C9EHVX-9	VUH27D	IMR9C-9H
SK20PR-A11	IFR6E-11	U16FSR-UB	CR5HSB	U27FE9	C9EH-9	VUH27Z	IMR9A-9H
SK20PR-A8	IFR6E	U17F	C5HSA	U27FER-ZU9	CR9EHVX-9	VW16	BPR5EIX
SK20PR-L9	IFR6C	U20EPR-9	CPR6EA-9S	U27FER9	CR9EH-9	VW20T	BPR6EIX-LPG
SK20R11	IFR6T11	U20ESR-N	CR6E	U31ESR-N	CR10E	VX22BZ	IJR7A9
SK22PR-M11	IFR7G-11KS	U20FS	C6HSA	U31ETR	CR10EK	VXEHC24G	ILZKAR8H8S
SKJ16CR-L11	IZFR5F-11	U20FS-L	C6HSA	U31FER9	CR10EH-9	VXU22	DCPR7EIX-P
SKJ16DR-M11	IZFR5K-11	U20FS-U	C6HSA	V01	BCPR5EIX-11P	VXUH20I	SILKR6C10E
SKJ20DR-M11	IZFR6K-11	U20FSR-L	CR6HSA	V02	BCPR6EIX-11P	VXUHC22G	ILZKR7D8
SKJ20DR-M13	IZFR6K-13	U20FSR-U	CR6HSA	V04	IZFR6H11	W14	B-4
SVK20RZ11	BKR6EIX-11	U20M-U	CM-6	V08	DCPR7EIX-P	W14-U	B-4
SVK20RZ8	BKR6EIX-P	U22ES-N	C7E	V10	IFR7F-6D	W14-U10	B-4-10
SXU22HCR11S	SILZKR7C11S	U22ESR-N	CR7E	V14	IJR7A9	W14-US	B-4
SXU22HPR9	ILKR7D-9	U22ETR	CR7EK	V17	ILZFR5B	W14E	B4ES
T14PR-U	BPR4FS	U22FER9	CR7EH-9	V18	ILZFR6D11	W14EKR-S11	BUR4EB-11
T14PR-U15	BPR4FS-15	U22FS	C7HSA	V19	LFR7AIX-P	W14EP	BP4ES
T16-U15	BPR5FS-15	U22FS-GU	C7HV	V25	HB6BIX-11P	W14EPR	BPR4ES
T16EPR-U	BPR5EFS	U22FS-L	C7HSA	V26	IMR8C-9H	W14EPR11	BPR4ES-11
T16EPR-U15	TR55IX	U22FS-U	C7HSA	V27	IMR9C-9H	W14EX-U	BP4EY
T16EX-U	BP5EFS	U22FS-ZU	C7HVX	V31	IMR9B-9H	W14EX-U11	BP4EY-11
T16P-U	BP5FS	U22FSR-L	CR7HSA	V33	IZFR6F-11	W14EX-U13	BPR4ES-13
T16PR-U	BPR5FS	U22FSR-U	CR7HSA	V39	LFR6AIX-P	W14EX-ZU	BPR4EVX
T16PR-U11	BPR5FS-11	U22FSR-U	CR7HSA	V42	IMR9C-9HES	W14EXR-U	BPR4EY
T16PR-U15	BPR5FS-15	U24ES-N	C8E	VCH20	ILKAR7L-11	W16EXR-U11	BPR6ES-11
T16R-U	BPR5FS-15	U24ESR-N	CR8E	VFKBH20	DFH6B-11A	W16R-U11	BPR6EY-11
T16R-U15	BR5FS-15	U24ESR-NB	CR8EB	VFKH20	DILFR6D-11	W16TT	BPR5ES
T16VR-U10	TR5B-13	U24ESR-NZU	CR8EVX	VFXEH20	PLZKAR6A-11	W20EX-U	BP6ES
T20EP-U	BP6EFS	U24ETR	CR8EK	VFXEHC22G	DILZKAR7C-11S	W20EXR-U	BPR6EY
T20EP-U15	BPR6EFS-15	U24FE9	C8EH-9	VK16	BKR5EIX-11P	W20TT	BPR6ES
T20EPR-U	BPR6EFS	U24FER-ZU9	CR8EHVX-9	VK16PRZ11	IFR5L-11	W22EP-U	BP7ES
T20EPR-U15	BPR6EFS-15	U24FER9	CR8EH-9	VK20	IFR6J-11	W22TT	BPR7ES
T20EX-U	BP6EFS	U24FS	C8HSA	VK20PRZ11	IFR6L11	W24EMR-C	BR8ECM
T20P-U	BP6FS	U24FS-C	LR8A	VK20T	BKR6EIX-LPG	W9	B-2
T20PR-U	BPR6FS	U24FS-L	C8HSA	VK20Y	BKR6EIX-P	W9-U	B-2
T20R-U	BR6FS	U24FS-U	C8HSA	VK22	BKR7EIX-P	W9EP	BP2E
T20R-U15	BR6FS-15	U24FS-ZU	C8HVX	VK22PRZ11	IFR7L-11	W9EPR	BPR2E
T20TT	BPR6EFS	U24FSR-C	LR8A	VKA20	HB6AIX-11P	W9EX-U	BPR2ES
T22EP-U	BP7EFS	U24FSR-U	CR8HSA	VKB20	HB6BIX-11P	W9EXR-U	BPR2ES
TV15TT	TR5B-13	U24FSR-ZU	CR8HVX	VKH16	LFR5AIX-11P	W9FP	BP-2H
U14FS-UB	C4HSB	U27ES-N	C9E	VKH20	LFR6AIX-11P	W9FP-L	BP2HS
U14FSR-UB	CR4HSB	U27ES-NZU	C9EVX	VKH22	LFR7AIX-P	W9FP-UL	BP2HS



SPARK PLUG CONVERSION CHART

EYQUEM TO NGK



 Denso	 NGK
W9LM-US	B2-LM
W9LMR-US	BR2-LM
W9P	BP-4
W9P-U	BP-4
W9PR-U	BP-4
WF20TT	BPR6HS
X22ES-U	D7EA
X24EPR-U9	DPR8EA-9
XU22EPR-U	DCPR7E
XU22HDR-9	LKR7B-9
XU22PR9	DCPR7EA-9
XU22TT	DCPR7EA-9
XUH20TTI	LZKR6B-10E
Y24FERC	ER8EH
Y27FERC	ER9EH
Y31FERC	ER10EH
Z20ESU	D6EA
ZC20HPR11	ILKAR7L-11
ZXU20PR11	IKR6G-11

 EYQUEM	 NGK
1000	B8HS
1000 MOTO	B8HS
1000CM	B7S
1000L	B8ES
1000L MOTO	B8HS
1000M	B8HS
100M	B8HS
1100	B9HS
1100L	B8ES
1100L MOTO	B8ES
1150L	B9ES
200	B4H
202CT	B2-LM
300AM	B4L
30AM	B4L
400J	BPR5FS-15
406	BP6HS
450JS	BPR4FS-15
450L	B5ES
480CS	BP5S
500AM	B6L
500C	B6S
500CJT	BM6F
500CM	B6S
500CS	BP5S
500CT	BM6A
500J	BR6FS
500JS	BPR4FS
500M	B5HS
502 MOTO	B4H
502CT	B4-LM
505JS	BP5FS
50AM	B6L
50M	B5HS
520CS	BP5S
550CS	BP5S
550JS	BPR5FS
550LS	BP5ES
550S	BP4HS
550S	BP4HS
580LS	BP5ES
580LS	BP5ES
580S	BP4HS
600CS	BP5S
600JS	BPR6FS

 EYQUEM	 NGK
600L	B6ES
600LS	BP6ES
600S	BP5HS
700	B6HS
700 MOTO	B6HS
700CTS	BPM6A
705JS	BP7FS
705L	B6ES
705L MOTO	B6ES
705S	BP6HS
705S MOBY MOTO	B5HS
707LS	BP6ES
70M	B6HS
750	BP6HS
750L	B6ES
750LJS	BP6EFS
750LS	BP6ES
753LJS	BP6EFS
755	B6HS
755 MOTO	B6HS
755CJT	BM7F
755CM	B6S
755CT	BM7A
755L	B6ES
755L MOTO	B6ES
755LJS	BP6EFS
755LS	BP6ES
755LS MOTO	BP6ES
755M	B6HS
755S	BP6HS
75LM	B6ES
75M	B6HS
775SX	BP6HS
775X	B6HS
800L	B6ES
800LJS	BP6EFS
800LS	BP6ES
800LS MOTO	BP6ES
802L	B6ES
803LJS	BP6EFS
805L	B6ES
805L MOTO	B6ES
805LJS	BP7EFS
805LJSP	BP7EFVX
805LP	B8EVX

 EYQUEM	 NGK
850	B7HS
850 MOT	B7HS
850LS	BP7ES
883LJP	B8EFS
C32	B5HS
C32LS	BP5ES
C32LS	BP5ES
C32S	BP5HS
C42LJS3	BP6EFS
C42S	BP6HS
C52LS	BP5ES
C62	B7HS
C62LJS	BP6EF
C62LJS	BP6EFS
C62LS	BP6E
C62LS	BP6ES
C62LS3X	BP5ET
C62S	BP7HS
C72LJS	BP7EFS
C72LS	BP7ES
C72LS3X	BP6ET
C82LJS	BP7EFS
C82LS3X	BP7ET
C92LS	BP8ES
D1000	D8HA
D1000 MOTO	D8HA
D1000L	D9EA
D1050L	D9EA
D755 MOTO	D6HA
D775	D6HA
D800L	D7EA
D800L MOTO	D7EA
D900L	D8EA
FC42LS	BCP5ES
FC52LS	BCP5E
FC52LS	BCP5ES
FC58LS	BCP6ES
FC62LS	BCP6ES
FC62LS2	BCP6ES
FC62LS3	BP6ET
FC62LS3X	BCP6ET
FC72LS	BCP7ES
FC82LS	BCP7E
FC82LS1	BCP7ES
FC82LS2	BCP7ES



SPARK PLUG CONVERSION CHART

EYQUEM TO **NGK**



Eyquem NGK

FN52LS	BK5ESZ
K200M	A-6
K300J	A5FS
K300JS	AP5FS
K300M	A-6
K350JS	AP5FS
K450JS	AP5FS
K500M	A-6
K55JS	AP6FS
K600M	A-6
K750M	A-7
KC62JS	AP6FS
R1 000	BR8HS
R1000L	BR8ES
R850	BR7HS
RC32LS5	BPR4ES-11
RC42S	BPR6HS
RC52LS	BPR5EA
RC52LS5	BPR5EA-11
RC52LZ3EX	BUR5ET
RC52LZE	ZGR5A
RC58LZ3EX	BUR6ET
RC62HJSDP	PTR5A-13
RC62LJS	BPR6EFS
RC62LS	BPR6ES
RC62LS5	BPR6ES-11
RC62S	BPR7HS
RC82LS	BPR7ES
RC82LS5	BPR7EY-11
RFC42LS	BCPR5ES
RFC42LS2E	BKR5EK
RFC50LZ2E	BKR5EK
RFC52LS	BCPR5ES
RFC52LS3	BCPR5ET
RFC52LS5	BCPR5ES-11
RFC52LS5	BKR5E-11
RFC52LSP	BKR6EK
RFC52LZE	ZFR5F
RFC52LZK	BKR5EZ
RFC57LS3	BCPR6ET
RFC58LS	BKR6E
RFC58LS2E	BKR6EK
RFC58LS3	BCPR6ET
RFC58LS5	BCPR6ES-11
RFC58LS5	BKR6ES-11



Eyquem NGK

RFC58LSP	BKR6EZ
RFC58LZ	BKR6EY
RFC58LZ2	BKR6EKC
RFC58LZ2E	BKR5EZ
RFC58LZ3EX	BKUR6ET
RFC58LZ5	BKR6EY-11
RFC58LZE5	ZFR6F-11
RFC62LS3X	BCPR6ET
RFC62LS5	BCPR6ES-11
RFC62LZ3X	BKUR7ET
RFC82LS	BCPR7ES
RFC82LS5	BCPR7ES-11
RFN52HZ	LF5B
RFN58HZ	LF6B
RFN58LZ	BKR6EZ
T850	C7HSA



FALCON MOTORBIKES NGK

XKC62JS	APR6FS
---------	--------



Hella NGK

8EH-188-704-251	BP6EFS
8EH-1887014-771	ZFR6T-11G
8EH-188704-001	BPR5ES
8EH-188704-001	BPR5EY
8EH-188704-011	BCPR6E-11
8EH-188704-011	BCPR6ES-11
8EH-188704-011	BCPR6EY-11
8EH-188704-011	BKR6E-11
8EH-188704-011	BKR6EY-11
8EH-188704-021	BKUR5ETC-10
8EH-188704-021	BPR6ES
8EH-188704-021	BPR6ESZ-N
8EH-188704-021	BPR6EY
8EH-188704-041	BPR5ES-11
8EH-188704-041	BPR5EY-11
8EH-188704-051	BKR5E
8EH-188704-051	BKR5EYA
8EH-188704-071	BCP6ES
8EH-188704-071	BCPR6ES
8EH-188704-071	BKR6E
8EH-188704-071	BKR6EY
8EH-188704-071	BKR6EYA
8EH-188704-071	YM8RCP-9UBKR6EZ
8EH-188704-091	BKR6EK
8EH-188704-091	BKR6EKUB
8EH-188704-091	BKUR6EK
8EH-188704-101	DCPR7E-N
8EH-188704-111	ZFR6F-11
8EH-188704-111	ZFR6J-11
8EH-188704-121	LF5A-11
8EH-188704-121	LZFR5F-11
8EH-188704-131	LZKAR7A
8EH-188704-131	LZKAR7A
8EH-188704-141	LF5B
8EH-188704-151	BP6ES-11
8EH-188704-151	BP6EY-11
8EH-188704-151	BPR6ES-11
8EH-188704-161	BP5ES
8EH-188704-161	BP5EY
8EH-188704-171	BP6ES
8EH-188704-171	BP6ES-SP
8EH-188704-181	BKR5E-11
8EH-188704-181	BKR5EYA-11
8EH-188704-191	BKR6ES-11
8EH-188704-191	BKR6EYA-11



SPARK PLUG CONVERSION CHART

HELLA TO NGK



Hella	NGK
8EH-188704-211	DCPR7E
8EH-188704-211	DCPR7EA-9
8EH-188704-231	ZFR5F-11
8EH-188704-251	BPR6EFS
8EH-188704-291	BKR5ES
8EH-188704-321	D8EA
8EH-188704-331	AP6FS
8EH-188704-341	LFRA-11
8EH-188704-341	LFR6B
8EH-188704-341	LFR6C-11
8EH-188704-351	BPR7ES
8EH-188704-351	YH9RCP-8U
8EH-188704-361	TR6B-10
8EH-188704-371	BKUR6ET-10
8EH-188704-381	BKR5EK
8EH-188704-381	BKR5EKU
8EH-188704-381	BKR5ES-11
8EH-188704-391	BCRE527Y
8EH-188704-401	BKUR6ET
8EH-188704-411	TR5B-13
8EH-188704-421	BKUR5ETC-10
8EH-188704-661	BCPR7ES
8EH-188704-671	BP6ET
8EH-188704-691	BKR5EKB-11
8EH-188705-011	PFR6B-11
8EH-188705-011	PFR6J-11
8EH-188705-021	BKR6EP-11
8EH-188705-021	ILZFR6D-11
8EH-188705-021	PFR6G-11
8EH-188705-021	PFR6N-11
8EH-188705-031	PFR6B
8EH-188705-031	PFR6Q
8EH-188705-031	PFR6Q
8EH-188705-211	DCPR8EIX
8EH-188705-211	PFR8S8EG
8EH-188705-241	PZFR5D-11
8EH-188706-041	IFR5G-11
8EH-188706-051	ILFR6A
8EH-188706-081	ILZFR6D-11
8EH-188706-221	IZFR6K-11
8EH-188706-261	BKR6EQUP
8EH-188706-391	LZKAR6AP-11
8EH-197025-171	C7HSA
8EH-197025-271	BP7ES
8EH-197025-391	BP6HS

Hella	NGK
8EH-197025-441	BM6A
8EH-197025-441	BPM6A
8EH-197025-661	BP5FS
8EH-197781-781	DPR8EA-9
8EH-358002-031	ZFR6K-11
8EH188-704-401	BCPR6ET
CC9N-6	C7HSA
CF10P-6	D8EA
CF10RCP-11P	DPR8EA-9
CFM9RP-9	DCPR7E
CG8P-7	BP6HS
CH7P-8	BP5ES
CH7P-8	BP5EY
CH8P-8	BP6ES
CH8P-8	BP6ES-SP
CH9P-8	BP7ES
CM7RP-11	BKR5E-11
CM7RP-11	BKR5EYA-11
CM7RP-8	BKR5ES
CM8RP-11	BKR6ES-11
CM8RP-11	BKR6EYA-11
CN8P1-7	BM6A
CN8P1-7	BPM6A
CR7CP-9	BP5FS
CV8P-9	AP6FS
IM7RC-10P	IFR5G-11
IM8RC-11P	IFR6J-11
IM8RC-8P	BKR6EQUP
IM8RC5-11P	IZFR6K-11
IMJ8RC4-10	ILZFR6D-11
IMJ8RC4-10P	ILZFR6D-11
IMJ8RC4-8P	ILFR6A
IMJ8RC4-8P	ILZFR6D-11
INF8RC-11P	LZKAR6AP-11
PFM10RC-8	DCPR8EIX
PFM10RC-8	PFR8S8EG
PM7RC-10	PFR5R-11
PM7RC7-11	PZFR5D-11
PM8RC-11	BKR6EP-11
PM8RC-11	PFR6G-11
PM8RC-11	PFR6N-11
PM8RC-7	PFR6B
PM8RC-7	PFR6Q
PM9RC-10	PFR6J-11
PMJ8RC4-8	PLFR6A-11

Hella	NGK
PMR9C-10	PFR6B-11
PMU8RC4-8	PLFR6A-11
YFM9RCP-9U	DCPR7E-N
YFM9RCP-9U	DCPR7EA-9
YH7RCP-11U	BPR5ES-11
YH7RCP-11U	BPR5EY-11
YH7RCP-8U	BPR5ES
YH7RCP-8U	BPR5EY
YH7RCP-9U	BPR5ES
YH8RCP-11U	BKR5E
YH8RCP-11U	BP6ES-11
YH8RCP-11U	BP6EY-11
YH8RCP-11U	BPR6ES-11
YH8RCP-8U	BPR6ES
YH8RCP-8U	BPR6ES
YH8RCP-8U	BPR6ESZ-N
YH8RCP-8U	BPR6EY
YH9RCP-8U	BPR7ESZ-N
YHRCP-8U	BPR7ES
YHRCS-9T	BP6ET
YM7RCP-11U	BKR5ES-11
YM7RCP-8U	BKR5E
YM7RCP-8U	BKR5E
YM7RCP-8U	BKR5ES
YM7RCP-8U	BKR5EYA
YM7RCP5-11U	ZFR5F-11
YM7RCP5-8U	BCRE527Y
YM7RCS5-10	BKR5EKB-11
YM7RCS5-10T	BKUR5ETC-10
YM7RCS5-10T	BKUR5ETC-10
YM7RCS5-9D	BKR5EK
YM7RCS5-9D	BKR5EKU
YM7RCS5-9D	BKR5ES-11
YM8RCP-11U	BCPR6E-11
YM8RCP-11U	BCPR6ES-11
YM8RCP-11U	BCPR6EY-11
YM8RCP-11U	BKR6E-11
YM8RCP-11U	BKR6EY-11
YM8RCP-9U	BCP6ES
YM8RCP-9U	BCPR6ES
YM8RCP-9U	BKR6E
YM8RCP-9U	BKR6E
YM8RCP-9U	BKR6EY
YM8RCP-9U	BKR6EYA
YM8RCP-9U	BKR6EZ

Hella	NGK
YM8RCP5-11U	ZFR6F-11
YM8RCP5-11U	ZFR6J-11
YM8RCS5-10T	BKUR6ET-10
YM8RCS5-9D	BKR6EKUB
YM8RCS5-9D	BKUR6EK
YM8RCS5-9T	BCPR6ET
YM8RCS5-9T	BKUR6ET
YM8RCS5-9U	BKR6EK
YM9RCP-8U	BCPR7ES
YMJ7CP5-11U	LZFR5F-11
YMJ7RCP-9U	LF5B
YMJ7RCP5-11U	LF5A-11
YMJ8RCP-11U	LF6A-11
YMJ8RCP-11U	LF6B
YMJ8RCP-11U	LF6C-11
YMN8RCP-11U	ZFR6T-11G
YMU7RCP5-11U	LF5A-11
YMZ8RCP-11U	ZFR6K-11
YNF9RCP-9U	LZKAR7A
YNF9RCP-9U	LZKAR7A
YNF9RCP-9U	LZKAR7A
YS8RCP-11U	BPR6EF-11
YS8RCP-8U	BPR6EFS
YSJ7RCP-13U	TR5B-13



SPARK PLUG CONVERSION CHART

LODGE TO **NGK**



Lodge

NGK

15HLNY	BP6ES
25HL	BPR7ES
25HLD	BCP6ET
25HLNY	BP7ES
25XL	BP6ES
2BTNY	AP5FS
2HL	B7ES
2HLD	BCP6ES
2HLNY	BP7ES
2HNY	BP7HS
2HTNY	AP7FS
2HTY	BP6FS
2XL	BP6ES
3BTY	BP4FS
3HAN/M	B9S
3HLNY	BP7ES
3HNY	BP8ES
4HLNY	BP8ES
5HLNY	BP8ES
BLNY	BP5ES
BLTY	BPR5EFS
BTNY	AP5FS
BTY	BP5FS
C14	B5HS
CLNY	BP5ES
CN	B5HS
CNY	BP5HS
CTNY	AP5FS
CTY	BP5FS
HBN	B5HS
HBTNY	AP6FS
HBTY	BP5FS
HLNY	BP6ES
HNY	BP6HS
HT14	BP5FS
HT18	AP6FS
HTN	A6FS
HTN18	A7FS
HTNY	AP6FS

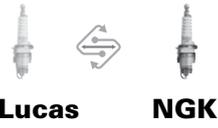

Lucas

NGK

HTY	BP6FS
-----	-------



Motorcraft NGK

A11	B-2
A11NX	BM4A
A11U	B-2
A11X	B-2
A1CU	B8S
A21X	B8S
A22	BP6S
A22CU	BP6S
A22NX	BPM7A
A2NX	BM7A
A32	BP6S
A3CU	B6S
A3X	B6S
A42	BP5S
A42CU	BP5S
A5	B6S
A52	BP5S
A52CU	BP5S
A5CU	B6S
A5X	B6S
A7	B4
A7LM	B4-LM
A7N	BM6A
A7NU	BM6A
A7NX	BM6A
A7U	B4
A7X	B4
A82	BP-4
A9	B4
A901	B8S
A9X	B4
ABSP32C	BKR6E-11
AE1C	B7HS
AE1X	B7HS
AE2	B7HS
AE22	BP6HS
AE22C	BP6HS
AE2C	B7HS
AE2X	B7HS
AE3	B6HS
AE32	BP6HS
AE32C	BP6HS
AE3C	B6HS
AE3X	B6HS
AE4	B5HS



Motorcraft NGK

AE42	BP5HS
AE4X	B5HS
AE6	B5HS
AE62	BP5HS
AE7	B4H
AE901	B9HS
AE901X	B9HS-10
AER32	BPR6HS
AER4	BR5HS
AER4X	BR5HS
AF12	BP7FS
AF2	B7FS
AF22	BP6FS
AF3	B6FS
AF3	B6S
AF32	BP6FS
AF3NX	BM7F
AF42	BP5FS
AF52	BP4FS
AF5NX	BM6F
AG1	B8ES
AG12	BP7ES
AG12C	BP7ES
AG12CU	BP7ES
AG1C	B8ES
AG1X	B8ES
AG2	B7ES
AG203	B11EGP
AG22	BP6ES
AG22-4	BP6ES-11
AG22C	BP6ES
AG22CU	BP6ES
AG23	B7ECS
AG252	BP6ES
AG252C	BP6ES
AG25C	B7EM
AG3	B6ES
AG32A	BP6ES
AG32C	BP6ES
AG32CU	BP6ES
AG3C	B6ES
AG3X	B6ES
AG4	B5ES
AG403	B10EGP
AG403C	B10EGP



SPARK PLUG CONVERSION CHART

MV AGUSTA TO NGK



Motorcraft NGK

AG42	BP5ES
AG42CU	BP5ES
AG44	ZGR5C
AG44CU	BP5EY
AGFS22IPJ	ITR6F-13
AGPR32C	BKR6E
AGSF22FE13J	PTR6D-13
AGSF22FE13J	PTR6F-13
AGSF24FM	TR55IX
AGSF24PM	TR55IX
AGSF32FM	PTR5F-13
AGSF32W	TR55IX
AGSP22YE09	IFR6T-11
AGSP32FP	PFR5G-11
AGSP52	BKR5E
AWSF22C	BPR6EFS
AWSF22FS	PTR6D-13
AWSF32F	PTR5D-10
AWSF32F	TR55
AWSF32PP	PTR5D-10
AWSF42	BPR5EFS
AWSF42C	BPR5EFS
AWSF44C	BPR5EFS



MV Agusta NGK

AYFS22P1	PTR5A-10
----------	----------



DISCONTINUED AND REPLACEMENT PLUGS



SPARK PLUG



SPARK PLUG

DISCONTINUED

REPLACED

A6	AB6
A7	AB7
B6EFS	BR6EF
B6EVX	B6ES
B6FS	BR6FS
B6HVX	BR6HIX
B7EVX	B7ES
B8HSA	BP8HS
B8HVX	BR8HIX
B9EGP	BR9EIX
BCP5E-11	BCPR5E-11
BCP5EY-11	BCPR5EY-11
BCP7E	BCPR7E
BCP7E-11	BCPR7E-11
BCP7EVX	BCPR7EIX-11
BCPR5EP-13	BCPR6EIX-11
BCPR6EP-13	BCPR6EIX-11
BCPR6EP-N-1	BCPR6EIX-11
BCPR8EVX-11	BKR8EIX
BK7EKU	BKR7EKU
BKR5EVX	BKR5EP-11
BKR6EVX	BKR6EIX
BKR6EVXA-13	BCPR6EIX-11
BKR7EVX	BKR7EIX
BP6EVX	BPR6EIX
BP6HVX	BPR6HIX
BP7EVX	BPR7EIX
BP8EVX	BPR8EIX
BP8HSA	BP8HS
BP9HVX	BPR8HIX
BPR7EVX	BPR7EIX
BPR7EY	BPR7ES
BPR7HVX	BPR7HIX
BPR8EVX	BPR8ES
BPR9EVX	BPR9EIX
BR7HVX	BPR7HIX
BR8ECMVX	BR8ECMIX
BR8EVX	BR8HIX
BR9ECMVX	BR9ECMIX
C6M	C6HSA
CR9EHVX-9	CR8EHIX-9
D8EVX	DR8EIX
D8HS	D8HA
DCPR8EVX	DCPR8EIX
DCPR8EVX	DCPR8EIX
DCPR9EVX	DCPR9EIX
DPR7EVX-9	DPR7EA-9
DPR9EVX-9	DPR9EIX-9
DR7ES	DR7EA
DR8E	DR8EA

DISCONTINUED

REPLACED

DR8ES	DR8EA
DR8EVX	DR8EIX
DR8EVX	DR8EIX
IFR7G-11K	IFR7G-11KS
IKR9F8	IKR9J8
IKR9F8	IKR9J8
ITR5F-13	ITR5H-13
PLZKBR7A-G	PLZKBR7B-8DG
R7236-8	R7436-8
R7236-9	R7436-9
R7238-10	R7436-10
R7238-8	R7436-8
R7238-8	R7436-9
R7239-10	R7436-10
R7239-9	R7436-9
R7279-9	R7434-9
R7282C-105	R7282-105
R7282M-105	R7282M-105
R8108-10	R8108A-10
R8108-95	R8108A-10
RE8A-L	RE8C-L
SD10	BUR9EQ
SD8	BUR8EQ
SD9	BUR9EQ
SR5	TR5-1
SR5	TR5-1IX
SR5-1VX	TR5IX
SR5VX	TR5-1IX
TR4-2	TR4
TR4-2	TR4IX
TR4-2VX	TR4IX
TR55GP	TR55IX
TR55VX	TR55IX
TR5VX	TR5
UR40	UR45
UR5VX	UR5IX
WR5GP	WR5IX
XFR5A-11	PFR5G-11
XFR6A-11	PFR6G-11
XR40	XR45
ZF4A-11	ZFR4F-11
ZF5A-11	ZFR5F-11
ZF6A-11	ZFR6A-11
ZF7A-11	ZFR7F-11
ZFR5FVX-11	ZFR5FIX-11
ZFR6FVX-11	ZFR6FIX-11
ZFR7A-11	ZFR7F-11
ZG5A	ZGR5A
ZTR7A	BR7EF



DISCONTINUED AND REPLACEMENT PLUGS



GLOW PLUG

DISCONTINUED

REPLACED

CX01	CX51
CY03	Y-603J
CY51	CZ259
CY52	CZ260
CY53	Y-603J
CY55	CZ256
CY57	CZ257
CY58	CZ261
CZ101	CZ104
CZ102	CZ106
CZ201	CZ251
CZ301	CZ304
CZ302	CZ303
CZ51	CX51
CZ57	CZ257
CZ71	CZ258
Y-118T-1	Y-118T1
Y-207TS	Y-207T
Y-503R	Y-503J
Y-504R	Y-504J
Y-506R	Y-506J
Y-507R	Y-507J
Y-515J	Y-732J
Y-525J	Y-548J
Y-701R	Y-701J
Y-720U	Y-720U1
Y-722J	Y-722JS
Y-731U	Y-503J
Y-731U	Y-503J
Y-732U	Y-732J
Y-742U	Y-710J
Y-743U	Y-711J



GLOW PLUG

DISCONTINUED

REPLACED

Y-746R	Y-746J
Y-901R	Y-918J
Y-902R	Y-924J
Y-904M	Y-904M1
Y-908R	Y-924J
Y-910R	Y-910J
Y-911J	Y-910J
Y-911R	Y-910J
Y-913M	Y-913J
Y-914U	Y-924J
Y-916R	Y-916J
Y-917U	Y-924J
Y-918R	Y-918J
Y-920R	Y-924J
Y-922R	Y-924J
Y-923U	Y-924J
Y-924U	Y-924J
Y-925R	Y-925J
Y-927R	Y-927J
Y-932R	Y-933J
Y-933R	Y-933J
Y-935U	Y-910J
Y-937R	Y-937J
Y-938R	Y-924J
Y-954M	Y-954M1
YE06	Y8003J
YI01	Y-306R
YI03	Y-104R
YM01	Y-251
YT01	Y-118T1
YZ01	Y-107R
YZ02	Y-107T



DISCONTINUED AND REPLACEMENT PLUGS



SPARK PLUGS

GLOW PLUGS

A-6	BCP7E	BPR4HS-10	ILFR6C-11	R5300A-10	R6242-8	CY03
A-7	BCP7EV	BPR6EFS-13	IZFR6K	R5300A-95	R6242-9	CY52
A-8	BCPR5ET	BPZHN-10	J9A	R5400-10	6,25E-102	CY53
A6	BCPR5EY-11	BR10EIX	L8A	R5400-7	6,25E-06	CY55
A7	BCPR6EP-11	BR10ET	LKR6D	R5400-8	R6254K-105	CY57
A7F	BCPR6EY	BR5HS	LKR6D-10	R5400-9	R6326-10	CY58
A7FS	BCPR8EVX-11	BR6EF	LKR6D-10	R5525-10	R6326-7	CZ21
A8F	BCRE527Y	BR6ES	PGR6A	R5525-11	R6326-8	CZ257
A8FS	BK5ESZ-N	BR7EQ	PTR6F-13	R5530-10	R6326-9	CZ51
A9F	BK7ESZ-N	BR7ET	R0045J-11	R5530-11	R6337-10	CZ71
A9FS	BK7ESZN	BR8EM	R016-10	R5540F-10	R6337-8	DG-211
AP6F	BKR4EVX	BR8EQ	R016-11	R5540F-105	R6337-9	DG-241
AP9FS	BKR5EVX-11	BR8EQ-14	R016-8	R5540F-11	R6385-105P	Y-119V
APR5FS	BKR6EKB	BR8ET	R016-9	R5649-10	R6385-11P	Y-145T
B105EGV	BKR6EKC-N-11	BR9ET	R017-10	R5649-11	R6690-9	Y-173
B105GP	BKR7EKC-N	BR9EYA	R017-8	R5671A-11	R6725-105	Y-175-2
B10EGV	BKR7EVX-11	BR9HIX	R017-9	R5673-10	R6725-11	Y-177
B10FS	BKUR5ETC-10	BU10H	R018-7	R5673-7	R6725-9	Y-201
B10HV	BKUR5ETZ-10	BUHX	R106-11	R5673-8	R6918B-7	Y-204-TS
B10HVX	BKUR6EB-11	BUR6EB-11	R2098-10N	R5686-10	R6918B-8	Y-252
B11EGV	BP10EVX	BZ7HS	R216-10	R5686-11	R7113-10	Y-452-1
B5HS-1.5	BP4	BZ7HS	R216-9	R5686-8	R7113-7	Y-709R
B6EFS	BP5ES-T	C6M	R217-10	R5686-9	R7113-8	Y-729U
B6FS	BP5ESL	C9EVX	R218-10	R5687-10	R7113-9	Y-732U
B7EV	BP5EV	C9H	R218-9	R5687-9	R7232-10	Y-808-1
B7EVX	BP5EVX	CR9EHVX-9	R2270-10	R5724-10	R7232-7	Y-901-R
B7HV	BP5HM	D6HA	R2270-11	R5796-8	R7232-8	Y-902-R
B85EGV	BP6E	D8EV	R4118S-10	R5830-10	R7232-9	Y-904M
B8EFS	BP6ES-T	D8HA	R4118S-8	R5830-8	R7233-10	Y-907R
B8EGV	BP6ESZ-N	D9EV	R4118S-85	R5830-9	R7233-8	Y-913
B8EM	BP6ESZN	DCPR8EVX	R4118S-9	R6120-10	R7234-10	Y-913J
B8EV	BP6EV	DCPR9EVX	R4452D-10	R6120-105	R7234-11	Y-916R
B8EVX	BP6H	DILKR8B6	R4452D-75	R6120-11	R7234-8	Y-918R
B8HCS	BP6HV	DIMR8B-10	R4468-105	R6120A-10	R7234-9	Y-920-R
B8HV	BP7E	DP8EV-9	R4468-11	R6120A-105	R7238-8	Y-925R
B8HVX	BP7ESZ-N	DP8EVX-9	R4468-115	R6120A-11	SD10A	YE06
B8S	BP7ESZN	DP9EV-9	R4468A-105	R6179-105P	SD11A	YI-01
B95EGV	BP7EV	DPR8EV-9	R4468A-11	R6179-10P	SR5	YI-03
B9ECS	BP8EV	DPR9EVX-9	R4468A-115	R6179A-105P	ZFR5E-11	YM-02
B9EGV	BP8EVX	DR5EA	R4468A-9	R6179A-11P	ZFR6A-11	YM-03
B9EV	BP8HVX	DR6HS	R4630A-95	R6179A-95P	ZFR6F-11	YS-101
B9HCS	BP9HVX	DR8ES	R5184-10	R6241-10	ZFR7F-11	YT-01
B9HV	BPMR4A-10	DR9EA	R5184-105	R6241-8	ZGR5B-11	YT-02
B9HVX	BPR10EVX	GR4VX	R5184-9	R6241-9	ZGR5C	YZ-01
BCP6EV	BPR4EVX	IKR7C	R5184-95	R6242-10		YZ-02



NGK GLOW PLUG TYPES & FEATURES

SHEATHED TYPE GLOW PLUG

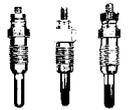

The heating coil is enclosed in a tube made of heat resistant alloy therefore the coil is not exposed to the combustion gas, giving improved coil durability.

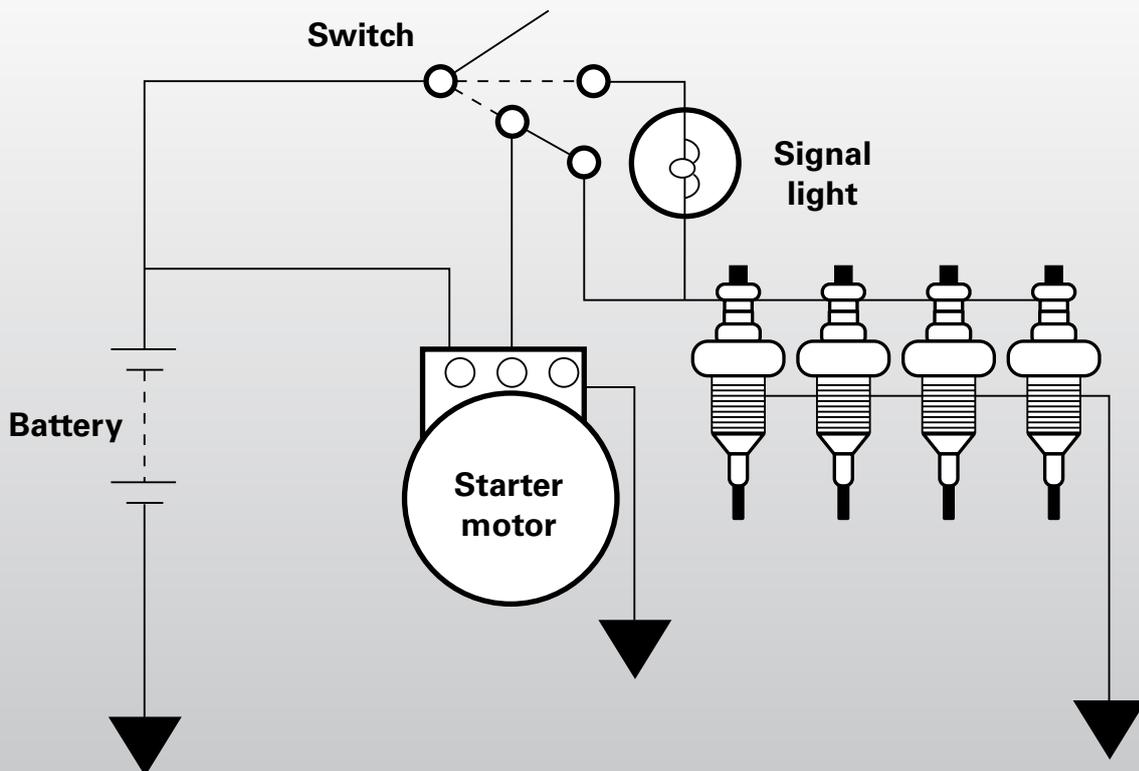
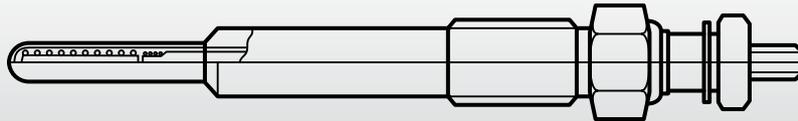

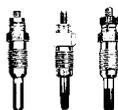

NGK GLOW PLUG TYPES & FEATURES

SHEATHED TYPE GLOW PLUG



SINGLE COIL TYPE

- The warm up time of the tip is slow.
- The coil will be damaged if current flows continuously.

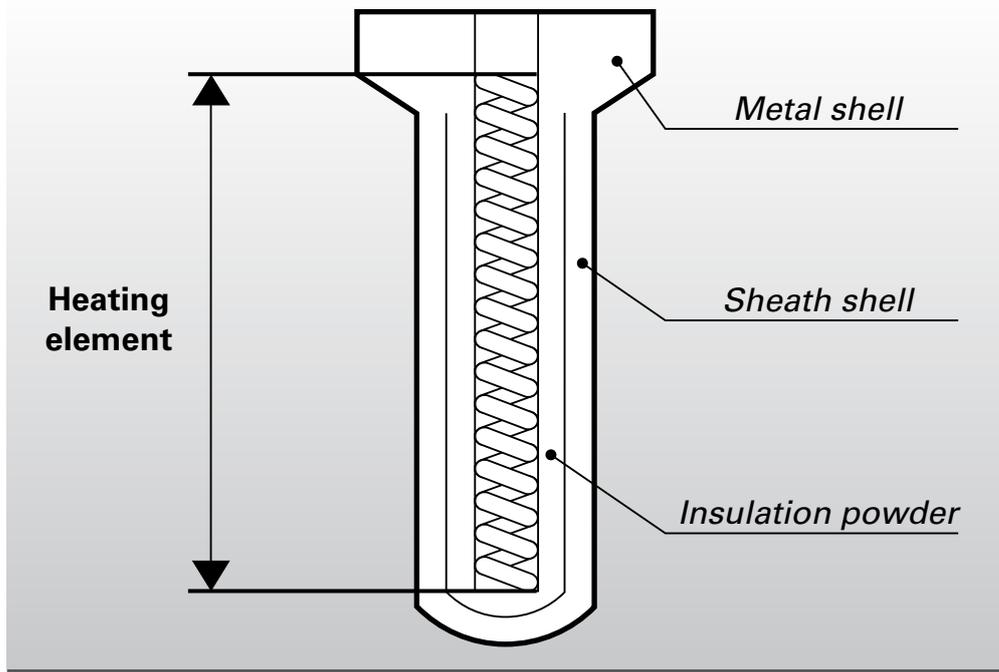

DOUBLE COIL TYPE

- The warm up time is much faster.
- The coil will not be damaged if current flows continuously
- Improved durability.

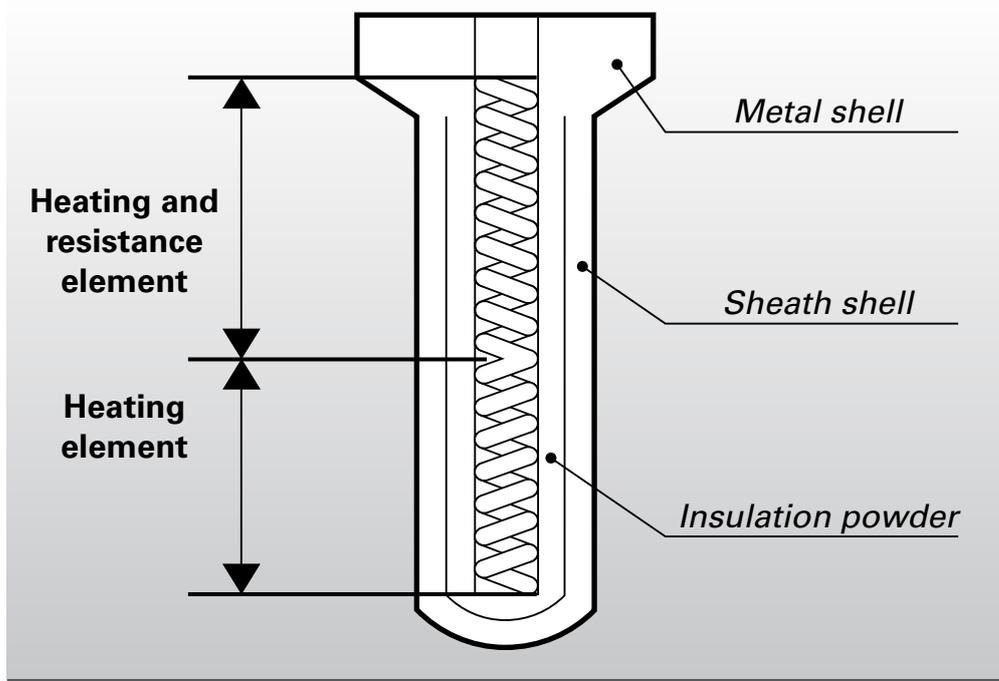



NGK GLOW PLUG TEMPERATURE CHARACTERISTICS

METAL SHEATHED GLOW PLUGS



STANDARD TYPE

The resistance of the heating coil does not change with temperature. Therefore, the current flowing through the coil is constant.

RAPID GLOW TYPE

The resistance of the heating coil increases as its temperature rises. Therefore when the coil is cold its resistance is low, allowing higher currents to flow which results in more rapid warm up.

Q.G.S. TYPE

The resistance characteristic of the heating coil is similar to that of the rapid glow type.

However, the total resistance value is lower which allows higher current to flow and therefore the warm up time is very quick.

Once the glow plug tip temperature has reached 900°C, its temperature is maintained by the controller relay switching the current on and off.

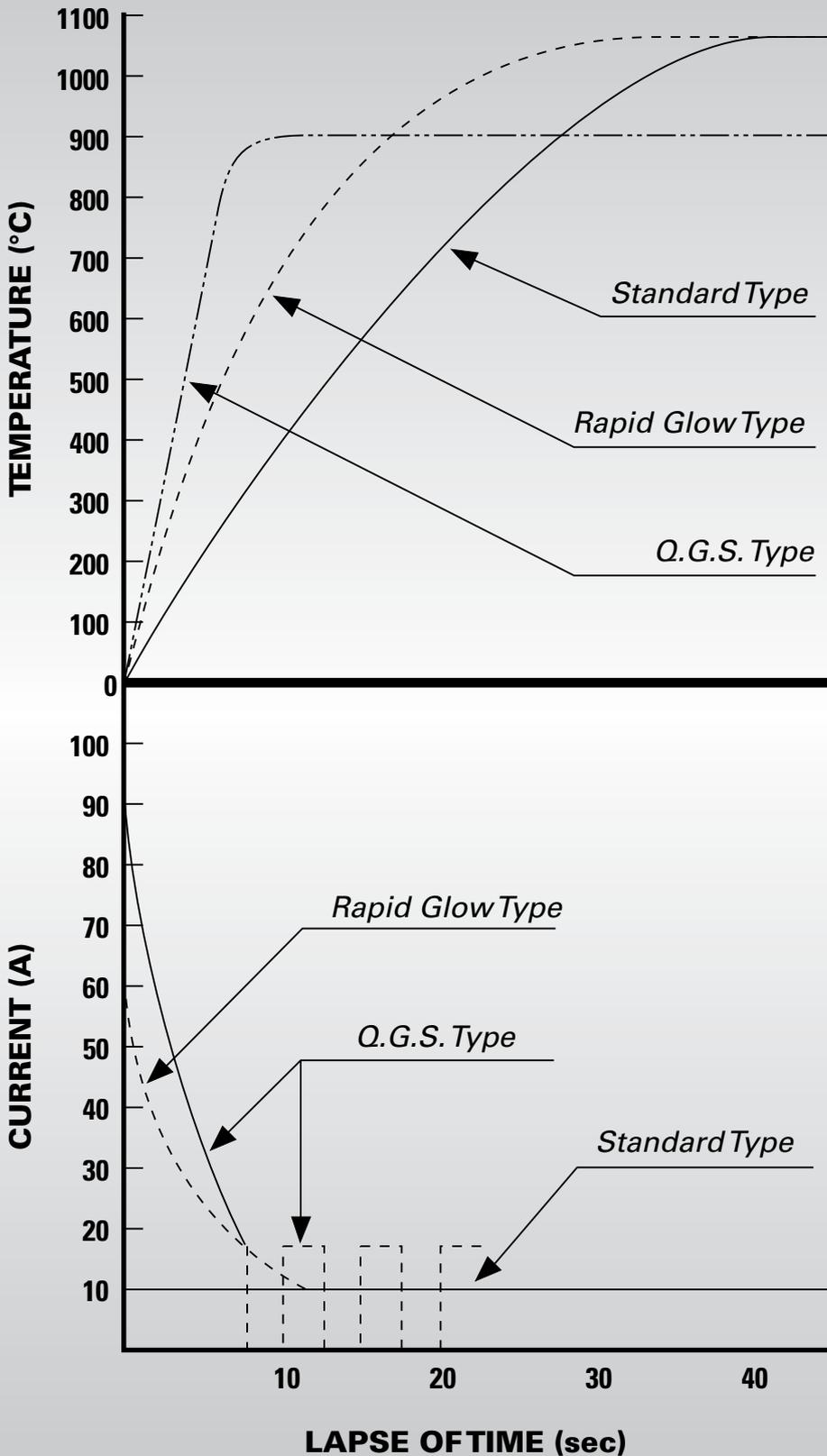



TESTING OF NGK GLOW PLUG



It is essential that the correct voltage and current are used in line with the vehicle manufacturers recommendations. If the voltage or battery capacity is too low, the glow plug will not get hot enough and the vehicle may fail to start. If the voltage is too high the heating coil may melt or the glow plugs service life will be reduced.

The pre-heating time for sheathed glow plugs is 20 seconds for standard types, 13 - 17 seconds for rapid glow plug types and 6 seconds for QGS types. For coil glow plugs it is 30 seconds.

In case of starting difficulties, do not allow current to flow continuously. This will drain the battery and reduce the service life of the glow plug. It is better to turn the glow plugs off for a short while and then try again.

INSPECTION OF SHEATHED TYPE GLOW PLUGS

In order to check the heating coil, measure its resistance as shown in the drawing.

Resistance value ∞ : The heating coil is broken

Resistance value less than 5 Ω : The heating coil is in good condition

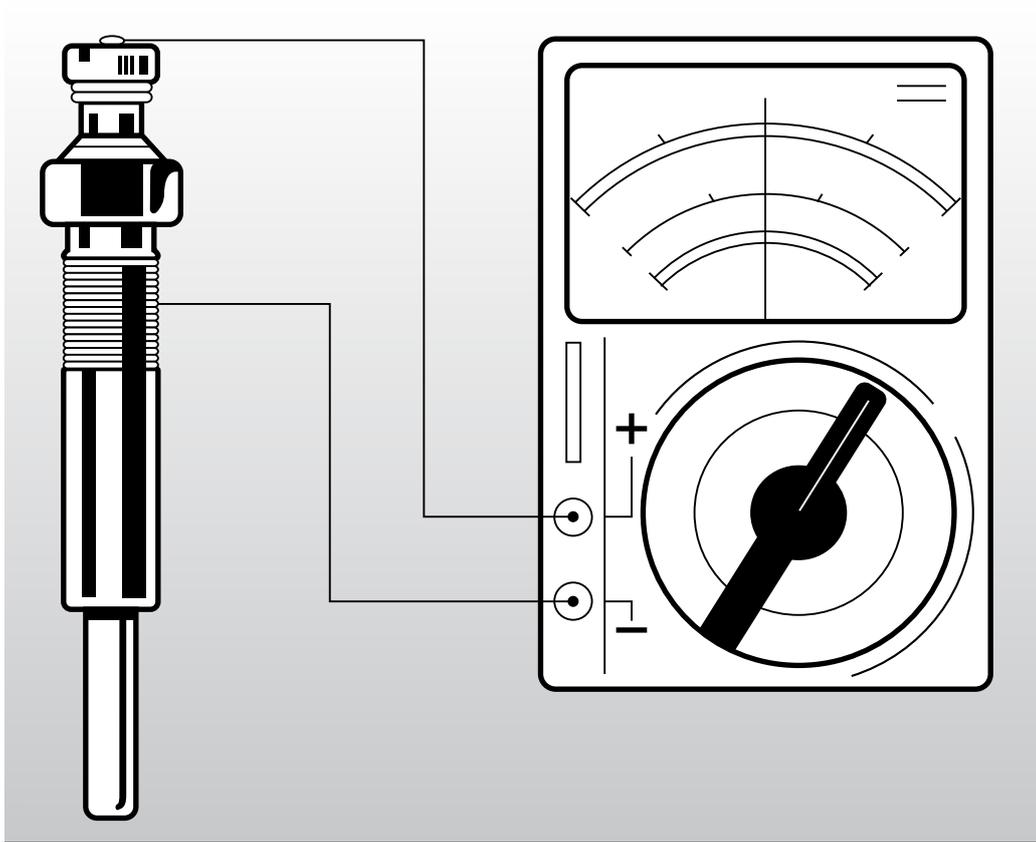



NEW SERIES OF GLOW PLUG



TEMPERATURE RISE AND CURRENT FLOW CHARACTERISTICS

Glow Plugs	Type of Glow Plugs	Temperature Rise Time
YI-01, YI-02, YM-01, YM-02	Standard Type	20 - 25 seconds to 800°C
YM-03, YT-01, YZ-02	Fast Heating Type	13 - 27 seconds to 800°C
YI-03, YI-04, YZ-01	QGS Type	6 seconds to 900°C
YT-02	Self-Regulating Type	8 seconds to 900 °C

* PLEASE NOTE: that all these glow plugs are sheathed type glow plugs.

TIPS ON INSTALLING GLOW PLUGS

- Ensure that all thread area's are clean and not damaged
- To ensure no cross-threading, please tighten the glow plugs by hand into the combustion chambers
- Apply correct torque to the glow plugs as indicated in the chart below

Thread Diameter	Tightening Torque
10mm	15~20N•m (1.5~2.0Kgm)
12mm	20~25N•m (2.0~2.5Kgm)
14mm	20~25N•m (2.0~2.5Kgm)
18mm	20~30N•m (2.0~3.0Kgm)



SERIES OF GLOW PLUG

(ACTUAL SIZE)

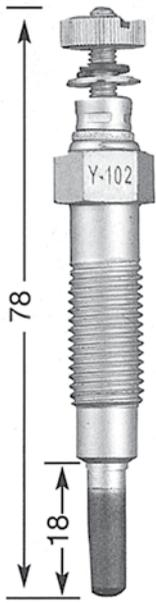

Y-102
M 10 x 1.25
12 Hex
10,5 V

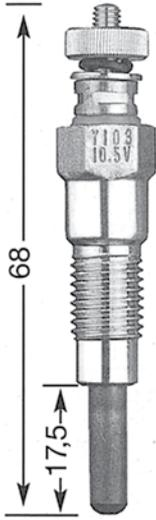

Y-103
M 10 x 1.25
12 Hex
10,5 V

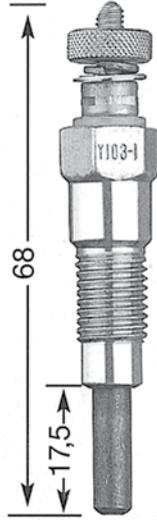

Y-103-1
M 10 x 1.25
12 Hex
10,5 V



Y-103-2
M 10 x 1.25
12 Hex
10,5 V

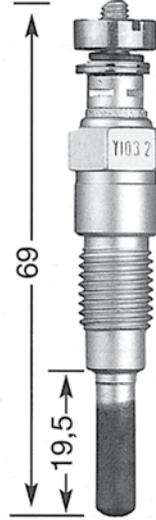

Y-103-2A
M 10 x 1.25
12 Hex
10,5 V

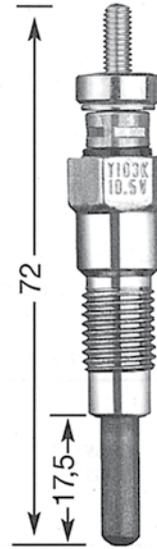

Y-103 K
M 10 x 1.25
12 Hex
10,5 V

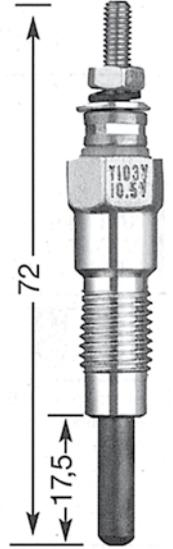

Y-103 V
M 10 x 1.25
12 Hex
10,5 V

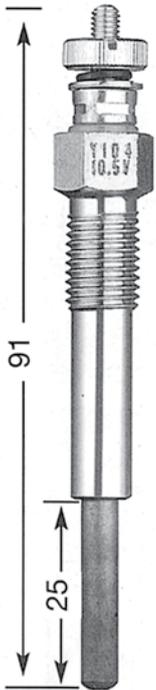

Y-104
M 10 x 1.25
12 Hex
10,5 V



Y-106-1
M 10 x 1.25
12 Hex
10,5 V

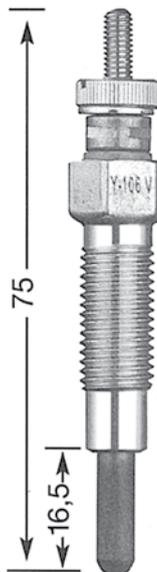

Y-106 V
M 10 x 1.25
12 Hex
10,5 V

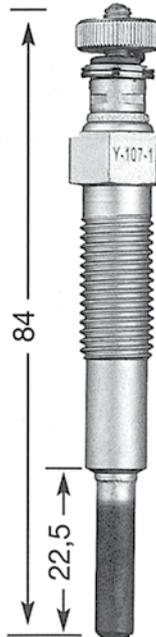

Y-107-1
M 10 x 1.25
12 Hex
10,5 V

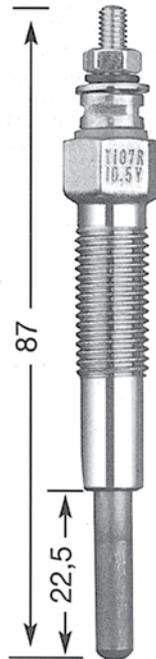

Y-107 R
M 10 x 1.25
12 Hex
10,5 V

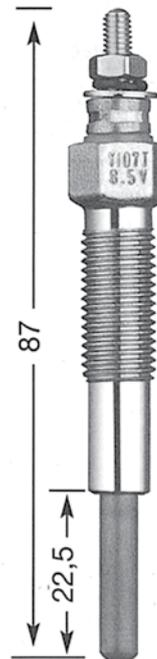

Y-107 T
M 10 x 1.25
12 Hex
8,5 V



Y-107 V
M 10 x 1.25
12 Hex
10,5 V



SERIES OF GLOW PLUG

(ACTUAL SIZE)

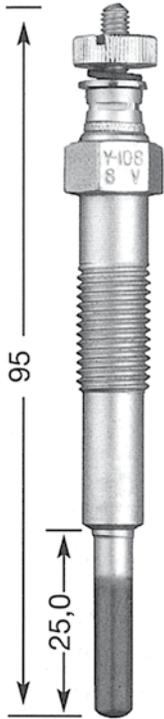

Y-108
M 10 x 1.25
12 Hex
8 V

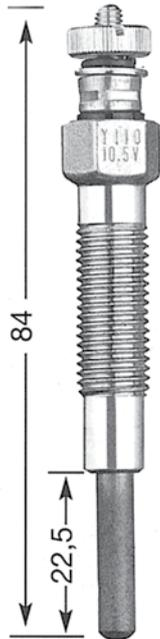

Y-110
M 10 x 1.25
12 Hex
10,5 V

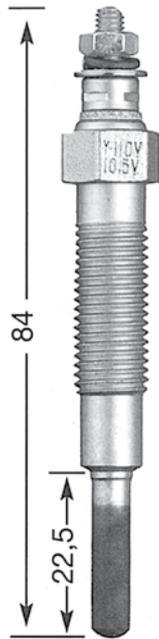

Y-110 V
M 10 x 1.25
12 Hex
10,5 V

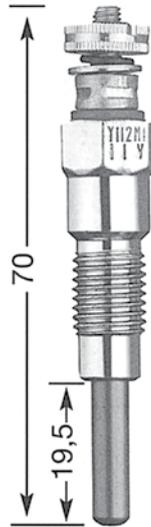

Y-112 M1
M 10 x 1.25
12 Hex
11 V

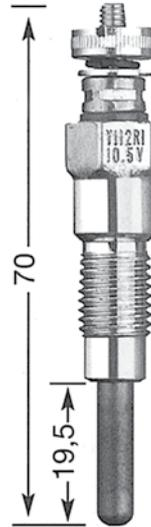

Y-112 R1
M 10 x 1.25
12 Hex
10,5 V

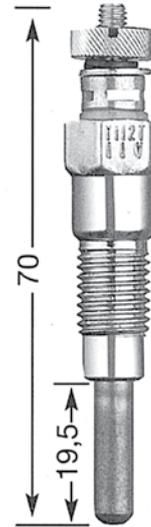

Y-112 T
M 10 x 1.25
12 Hex
11 V

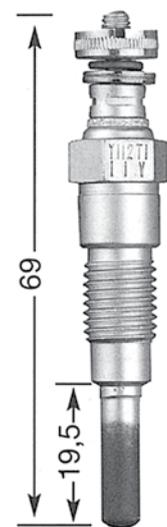

Y-112 T1
M 10 x 1.25
12 Hex
11 V



Y-112 TS
M 10 x 1.25
12 Hex
11 V

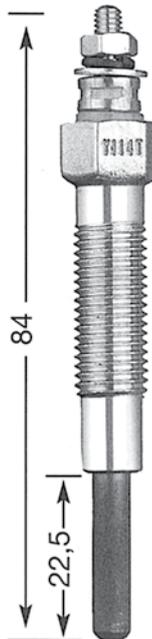

Y-114 T
M 10 x 1.25
12 Hex

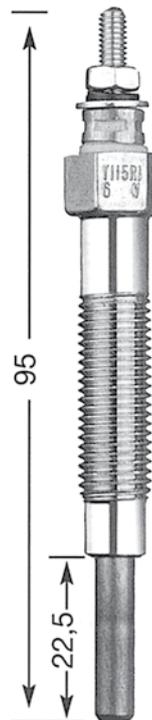

Y-115 R1
M 10 x 1.25
12 Hex
6 V

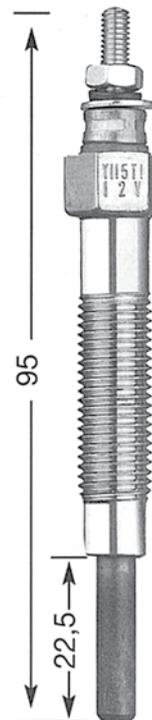

Y-115 T1
M 10 x 1.25
12 Hex
12 V



Y-116 V
M 10 x 1.25
12 Hex
10,5 V

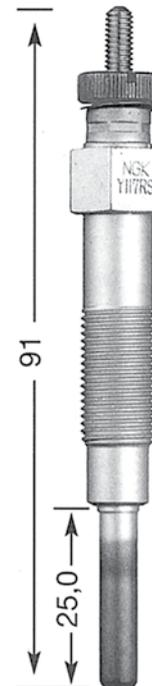

Y-117 RS
M 10 x 1
12 Hex
6,5 V

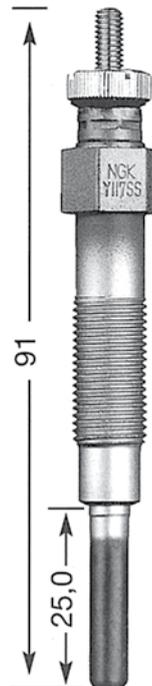

Y-117 SS
M 10 x 1
12 Hex
8,5 V



SERIES OF GLOW PLUG

(ACTUAL SIZE)

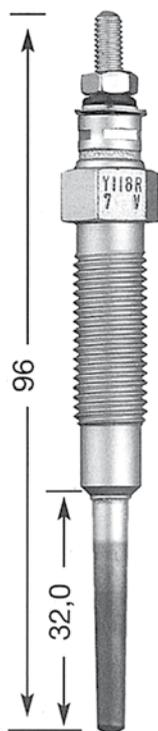

Y-118 R
M 10 x 1.25
12 Hex
7 V

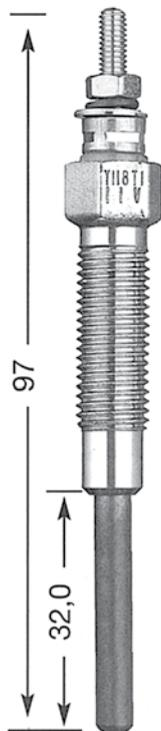

Y-118 T1
M 10 x 1.25
12 Hex
11 V



Y-119 V
M 10 x 1.25
12 Hex
10,5 V

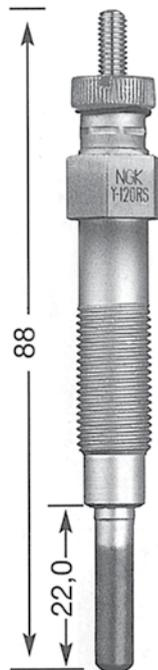

Y-120 RS
M 10 x 1
12 Hex
6,5 V

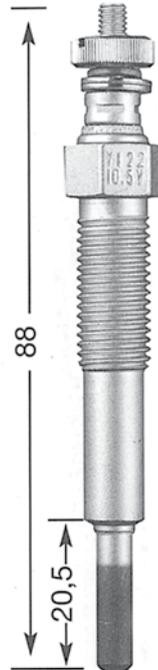

Y-128
M 10 x 1.25
12 Hex
8 V

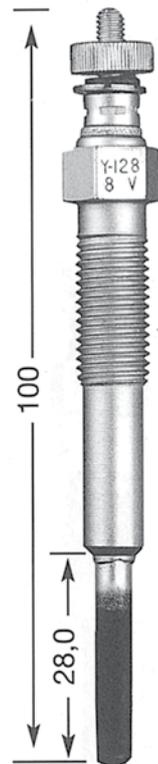

Y-128 T
M 10 x 1.25
12 Hex
8,5 V

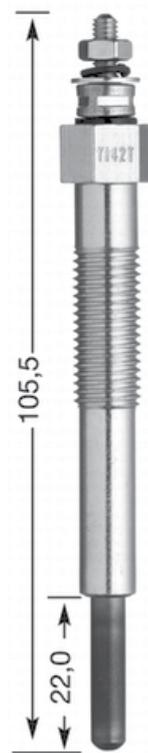

Y-142 T
M 10 x 1.25
12 Hex
12 V



Y-145 T
M 10 x 1.25
12 Hex
10,5 V

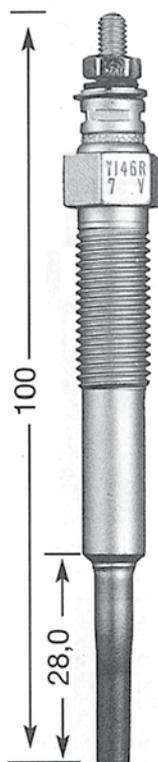

Y-146 R
M 10 x 1.25
12 Hex
7 V

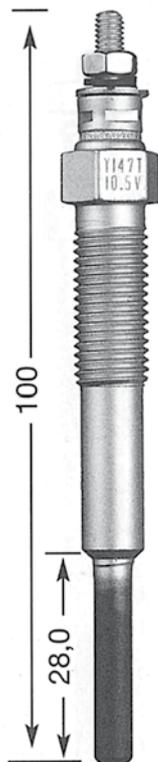

Y-147 T
M 10 x 1.25
12 Hex
10,5 V

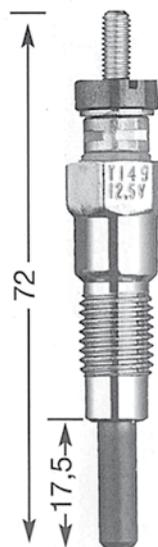

Y-149
M 10 x 1.25
12,5 Hex
12,5 V

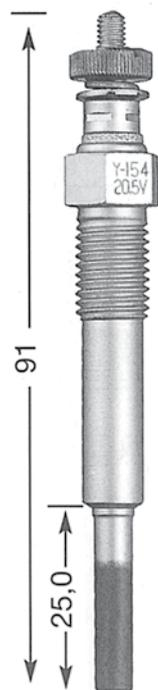

Y-154
M 10 x 1.25
12 Hex
20,5 V

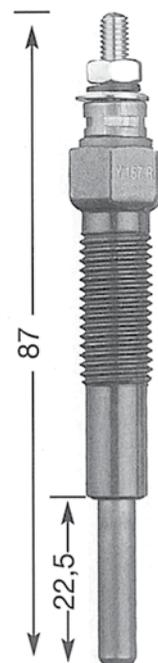

Y-157 R
M 10 x 1.25
12 Hex
23 V

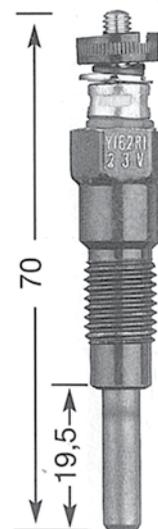

Y-162 R1
M 10 x 1
12 Hex
23 V



SERIES OF GLOW PLUG

(ACTUAL SIZE)

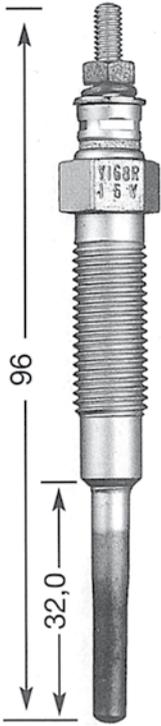

Y-168 R
M 10 x 1.25
12 Hex
16 V

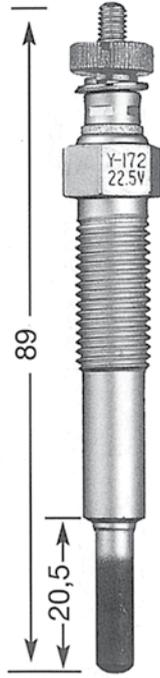

Y-172
M 10 x 1.25
12 Hex
22,5 V

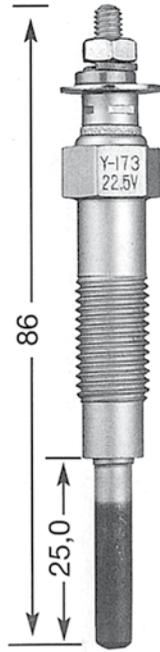

Y-173
M 10 x 1.25
12 Hex
22,5 V

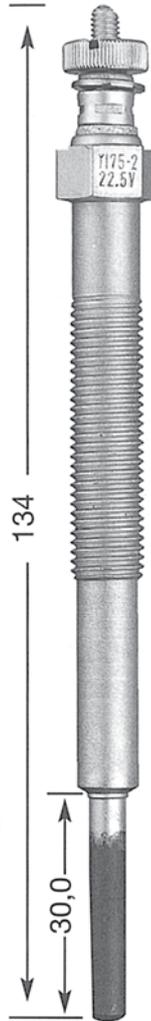

Y-175-2
M 10 x 1.25
12 Hex
22,5 V

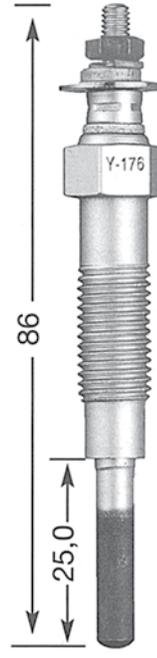

Y-176
M 10 x 1.25
12 Hex
19 V

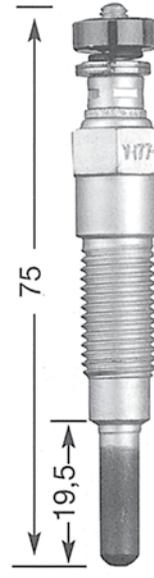

Y-177-1
M 10 x 1.25
12 Hex
21 V

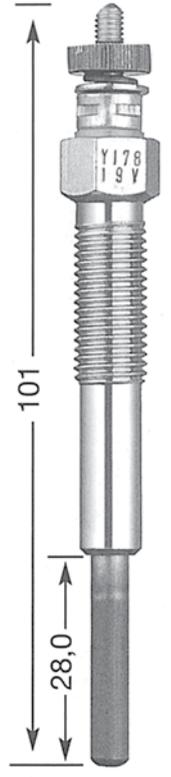

Y-178
M 10 x 1.25
12 Hex
19 V

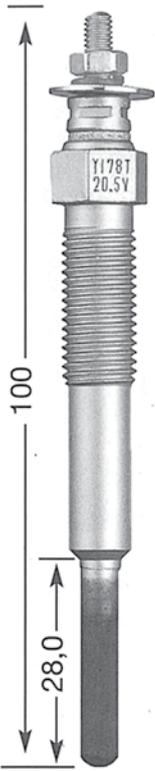

Y-178 T
M 10 x 1.25
12 Hex
20,5 V

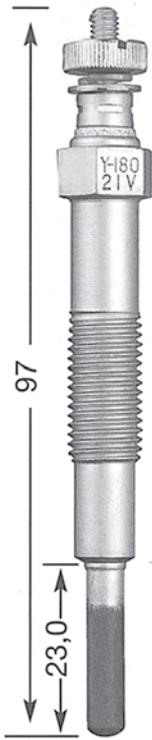

Y-180
M 10 x 1.25
12 Hex
21 V

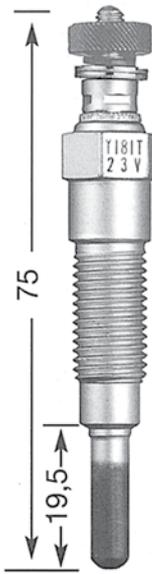

Y-181 T
M 10 x 1.25
12 Hex
23 V

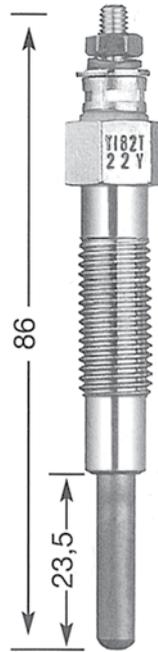

Y-182 T
M 10 x 1.25
12 Hex
22 V

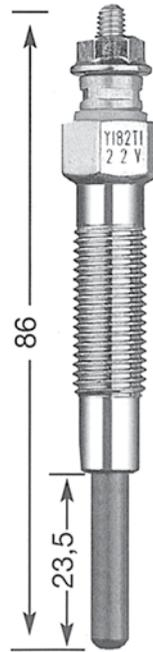

Y-182 T1
M 10 x 1.25
12 Hex
22 V

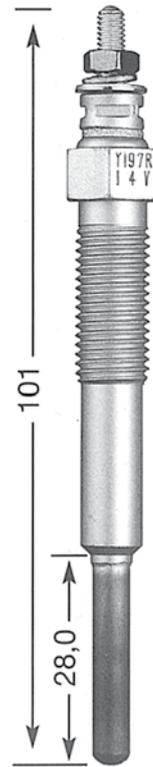

Y-197 R
M 10 x 1.25
12 Hex
14 V

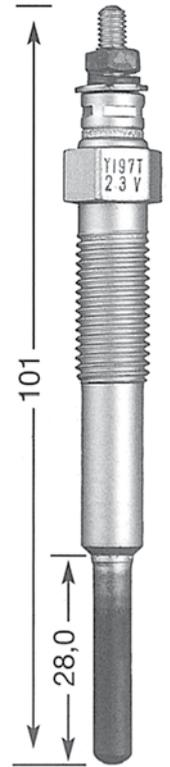

Y-197 T
M 10 x 1.25
12 Hex
23 V



SERIES OF GLOW PLUG

(ACTUAL SIZE)

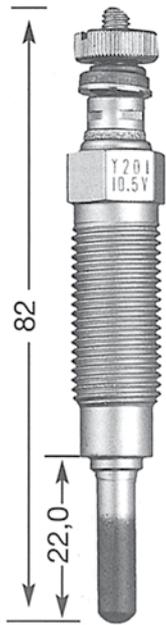

Y-201
M 12 x 1.25
12 Hex
10,5 V

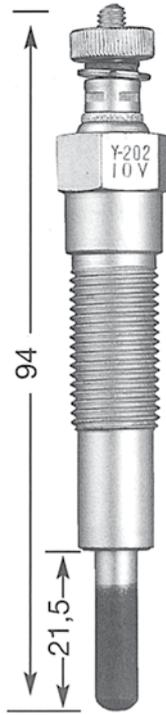

Y-202
M 12 x 1.25
14 Hex
10 V

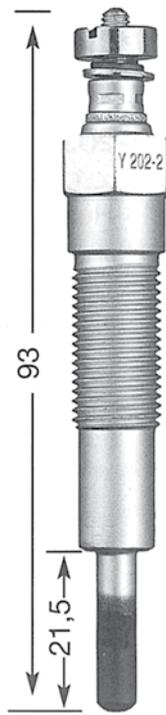

Y-202-2
M 12 x 1.25
14 Hex
9,5 V

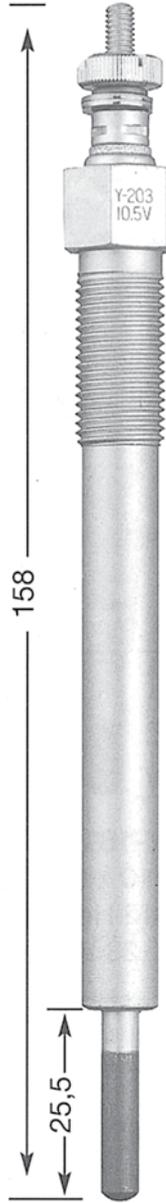

Y-203
M 12 x 1.25
14 Hex
10,5 V

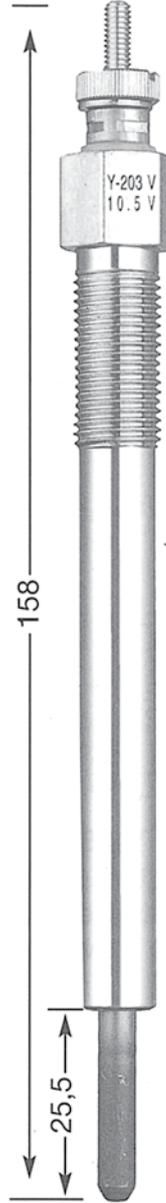

Y-203 V
M 12 x 1.25
14 Hex
10,5 V

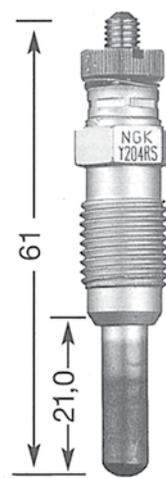

Y-204 RS
M 12 x 1.25
12 Hex
6,5 V

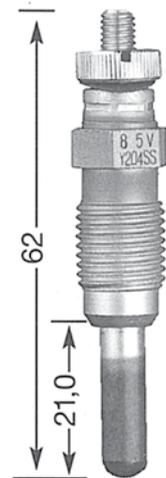

Y-204 SS
M 12 x 1.25
12 Hex
8,5 V

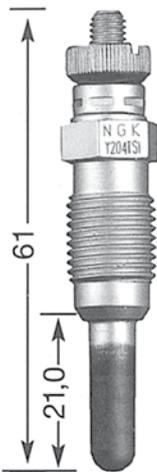

Y-204 TS1
M 12 x 1.25
12 Hex
11 V

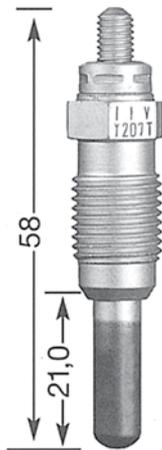

Y-207 T
M 12 x 1.25
12 Hex
11 V

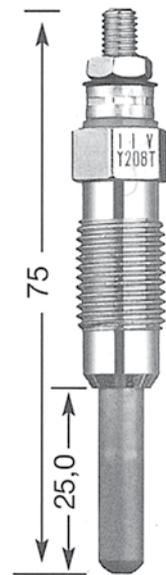

Y-208 T
M 12 x 1.25
12 Hex
11 V

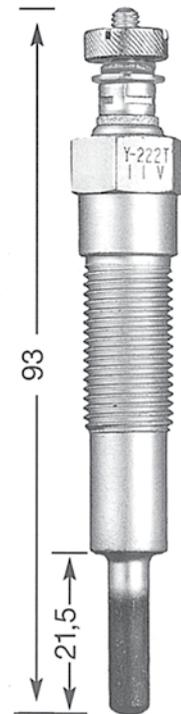

Y-222 T
M 12 x 1.25
14 Hex
11 V

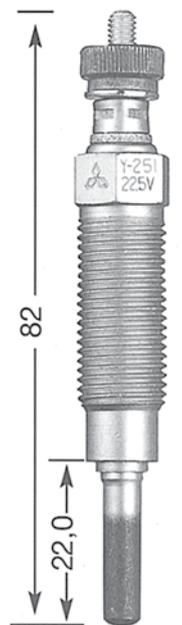

Y-251
M 12 x 1.25
12 Hex
22,5 V



SERIES OF GLOW PLUG

(ACTUAL SIZE)

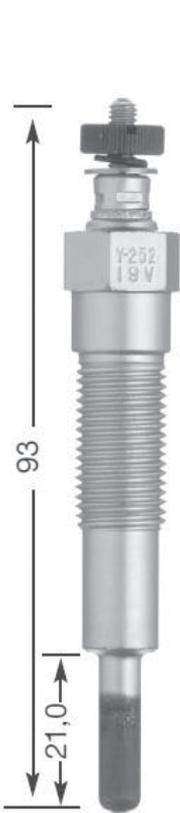

Y-252
M 12 x 1.25
14 Hex
19 V

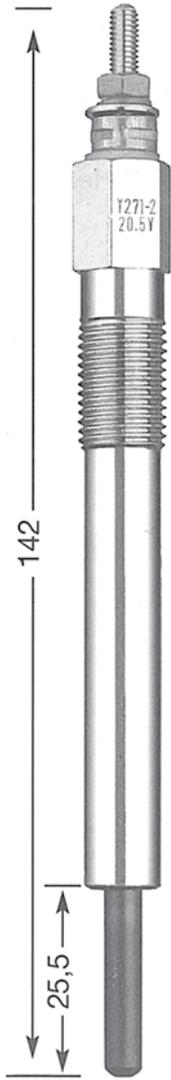

Y-271-2
M 12 x 1.25
12 Hex
20,5 V

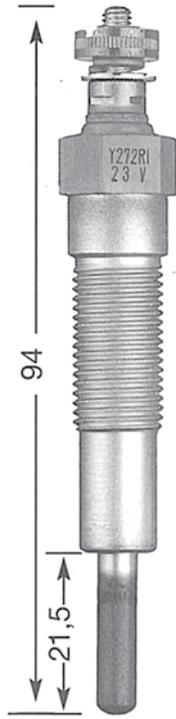

Y-272 R1
M 12 x 1.25
14 Hex
23 V

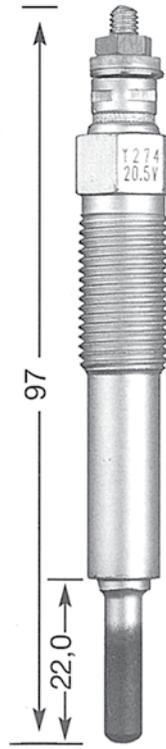

Y-274
M 12 x 1.25
12 Hex
20,5 V

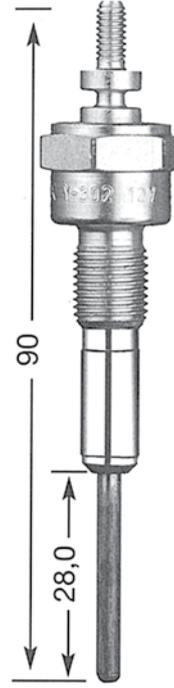

Y-302
M 10 x 1
17 Hex
12 V

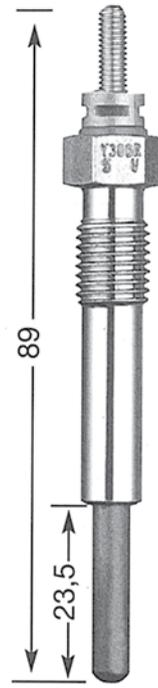

Y-306 R
M 10 x 1.25
12 Hex
5 V

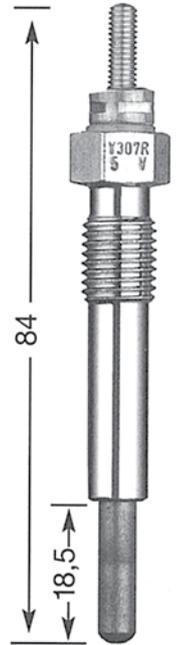

Y-307 R
M 10 x 1.25
12 Hex
5 V



Y-401-3
M 12 x 1.25
14 Hex
10,5 V

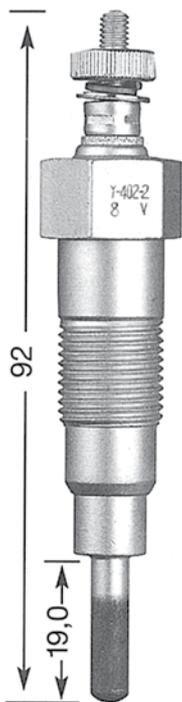

Y-402-2
M 14 x 1.25
17 Hex
8 V

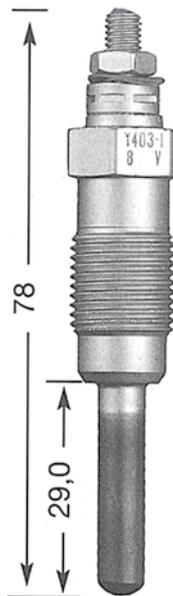

Y-403-1
M 14 x 1.25
14 Hex
8 V

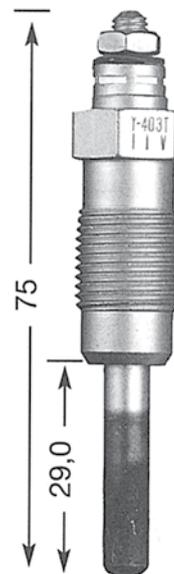

Y-403 T
M 14 x 1.25
14 Hex
11 V

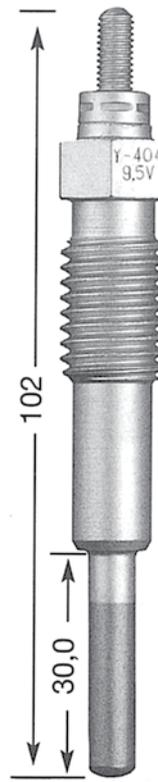

Y-404
M 14 x 1.5
14 Hex
9,5 V

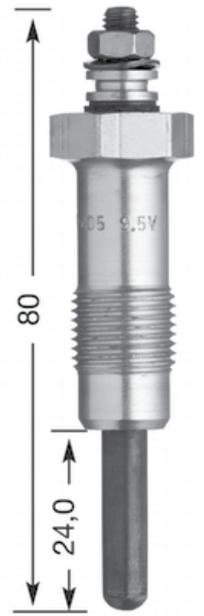

Y-405
M 14 x 1.25
17 Hex
9,5 V



SERIES OF GLOW PLUG

(ACTUAL SIZE)

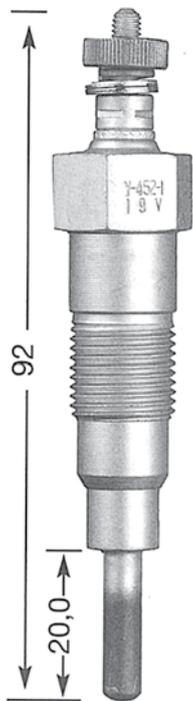

Y-452-1
M 14 x 1.25
17 Hex
19 V

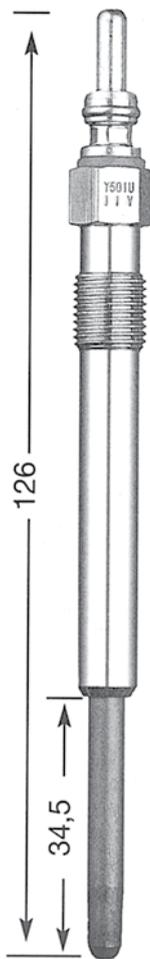

Y-501-U
M 10 x 1
10 Hex
11 V

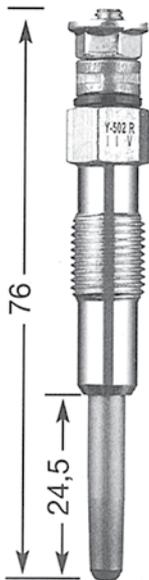

Y-502 R
M 10 x 1
10 Hex
11 V



Y-503 J
M 10 x 1
10 Hex
11 V

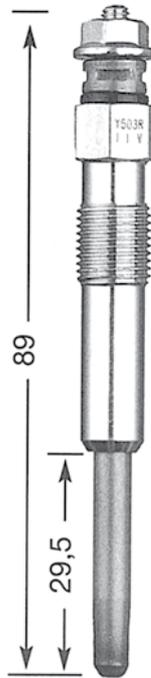

Y-503 R
M 10 x 1
10 Hex



Y-504 J
M 10 x 1
10 Hex
11 V

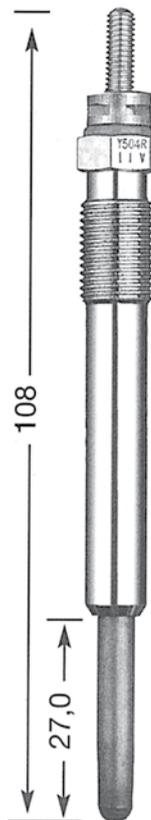

Y-504 R
M 10 x 1
10 Hex
11 V



Y-506 J
M 10 x 1
10 Hex
11 V

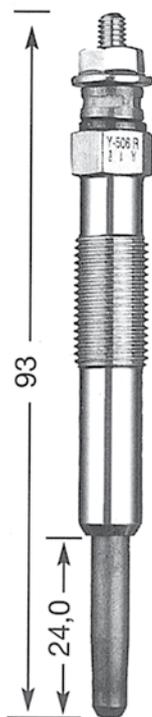

Y-506 R
M 10 x 1
10 Hex
11 V



Y-507 J
M 10 x 1
10 Hex
11 V

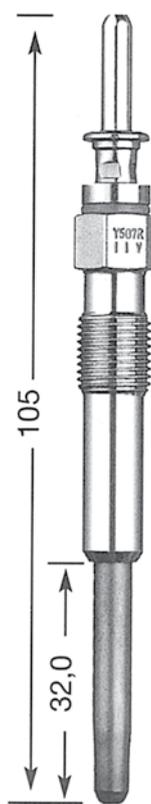

Y-507 R
M 10 x 1
10 Hex
11 V

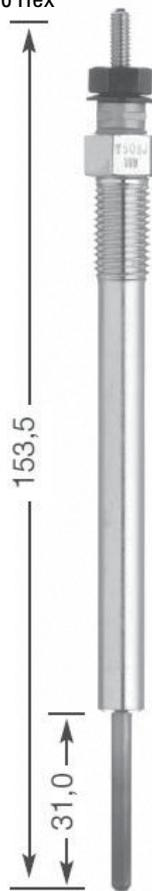

Y-508 J
M 10 x 1.25
12 Hex
11 V

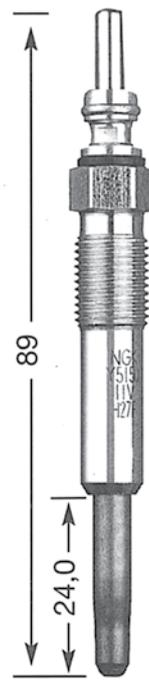

Y-515 J
M 10 x 1
10 Hex
11 V

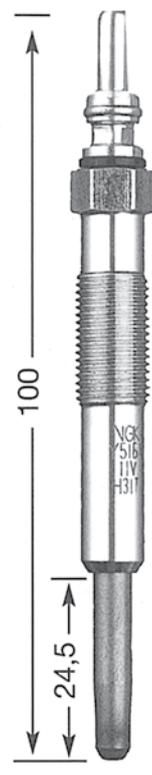

Y-516 J
M 10 x 1
10 Hex
11 V



SERIES OF GLOW PLUG

(ACTUAL SIZE)

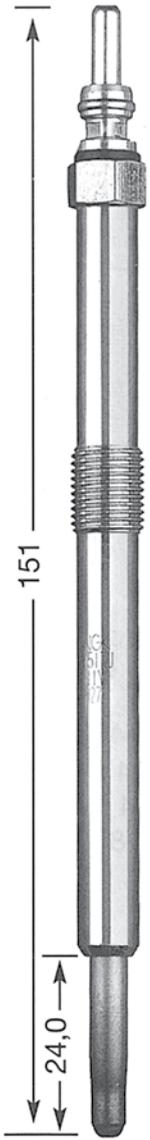

Y-517 J
M 10 x 1
10 Hex
11 V

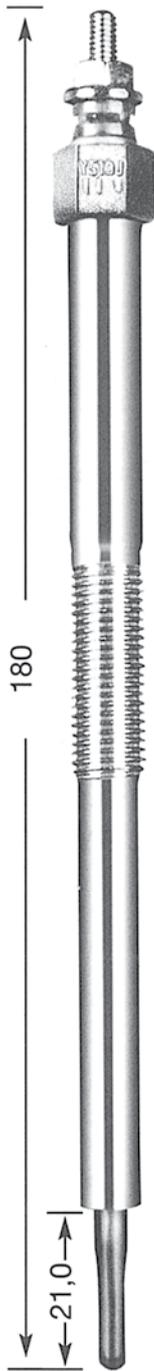

Y-519 J
M 10 x 1
10 Hex
11 V

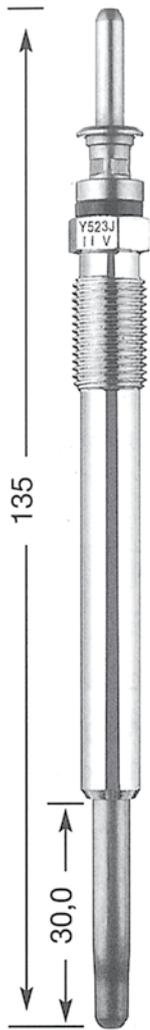

Y-523 J
M 10 x 1.25
10 Hex
11 V

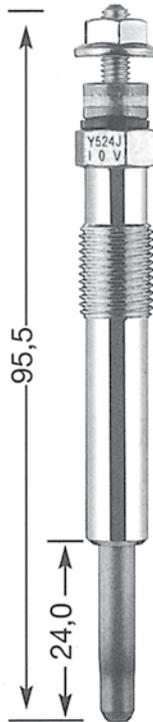

Y-524 J
M 10 x 1.25
10 Hex
10 V

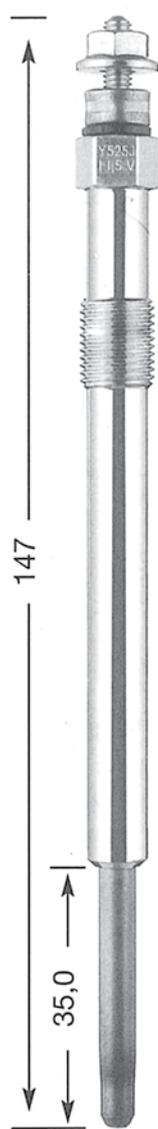

Y-525 J
M 10 x 1.25
10 Hex
11,5 V



Y-529 J
M 10 x 1.25
12 Hex
11 V

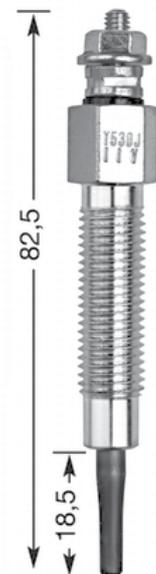

Y-530 J
M 10 x 1.25
12 Hex
11 V



Y-531 J
M 10 x 1.25
12 Hex
11 V

SERIES OF GLOW PLUG

(ACTUAL SIZE)



Y-532 J
M 10 x 1.25
12 Hex
11 V

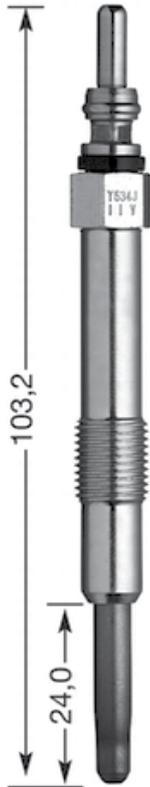

Y-534 J
M 10 x 1
10 Hex
11 V



Y-538 J
M10 x 1,25
12 Hex
11,0 V



Y-541 J
M 10 x 1.25
10 Hex
11 V



Y-542 J
M 10 x 1.25
10 Hex
11 V



Y-543 J
M 10 x 1.25
10 Hex
11 V

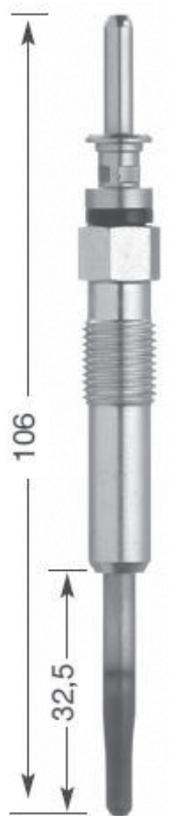

Y-547 AS
M 10 x 1
10 Hex
5 V



Y-607 AS
M 10 x 1
10 Hex
5 V



Y-609 AS
M 10 x 1
10 Hex
4,4 V

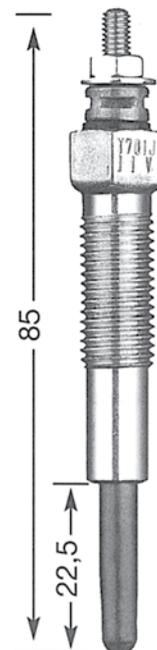

Y-701 J
M 10 x 1.25
12 Hex
11 V

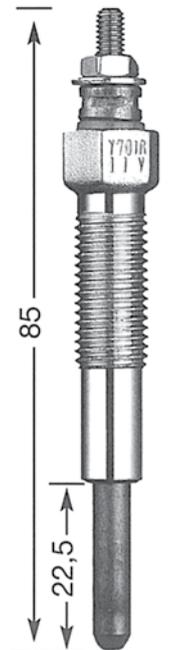

Y-701 R
M 10 x 1.25
12 Hex
11 V



SERIES OF GLOW PLUG

(ACTUAL SIZE)



Y-701 RS
M 10 x 1.25
12 Hex
11 V



Y-701 U
M 10 x 1.25
12 Hex
10 V

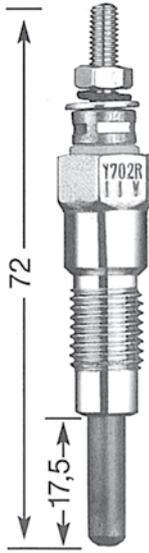

Y-702 R
M 10 x 1.25
12 Hex
11 V

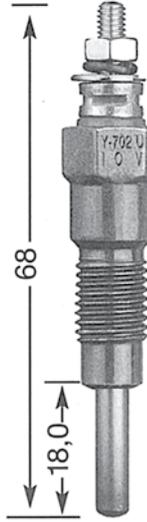

Y-702 U
M 10 x 1.25
12 Hex
10 V

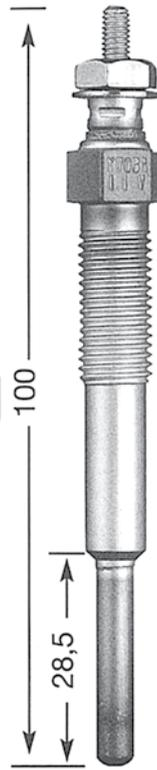

Y-703 R
M 10 x 1.25
12 Hex
11 V

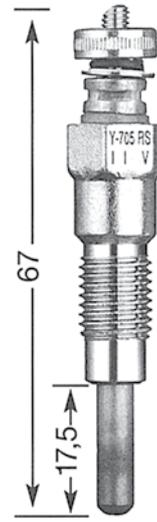

Y-705 RS
M 10 x 1.25
12 Hex
11 V

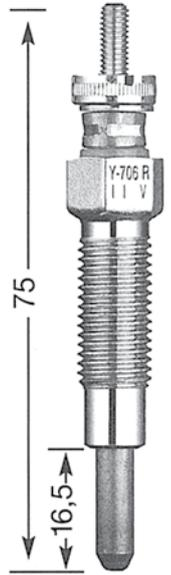

Y-706 R
M 10 x 1.25
12 Hex
11 V

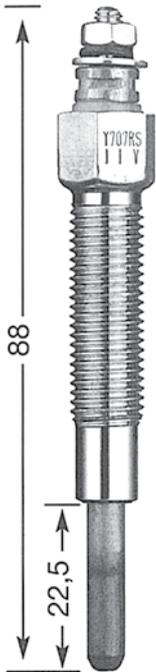

Y-707 RS
M 10 x 1.25
12 Hex
11 V

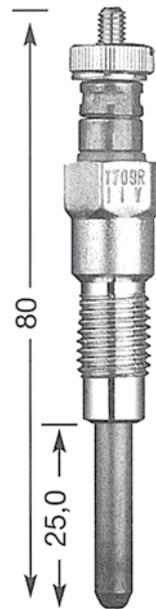

Y-709 R
M 10 x 1.25
12 Hex
11 V

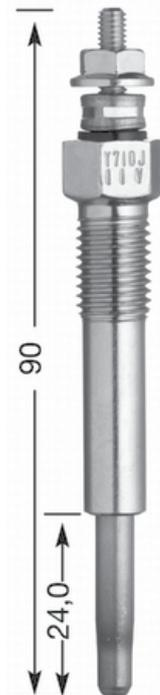

Y-710 J
M 10 x 1.25
12 Hex
11 V

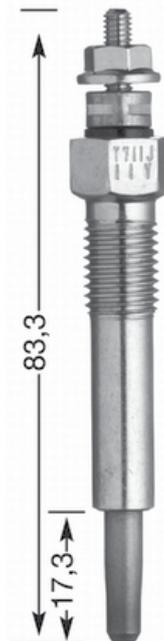

Y-711 J
M 10 x 1.25
12 Hex
11 V

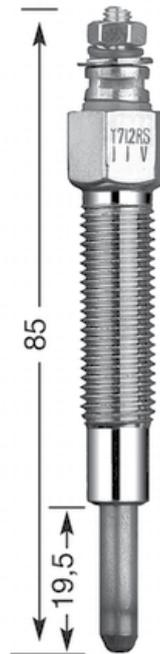

Y-712 RS
M 10 x 1.25
12 Hex
11 V



Y-713 R
M 10 x 1.25
12 Hex
11 V

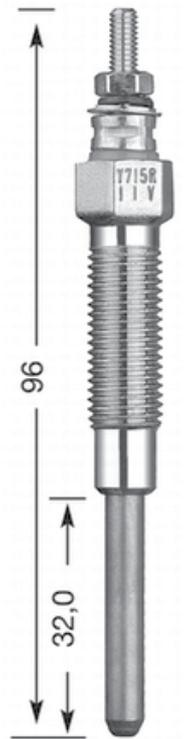

Y-715 R
M 10 x 1.25
12 Hex
11 V



SERIES OF GLOW PLUG

(ACTUAL SIZE)

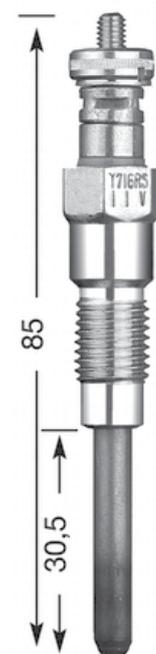

Y-716 RS
M 10 x 1.25
12 Hex
11 V

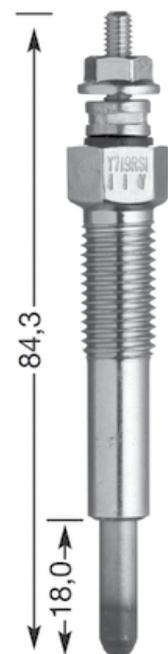

Y-719 RS
M 10 x 1.25
12 Hex
11 V

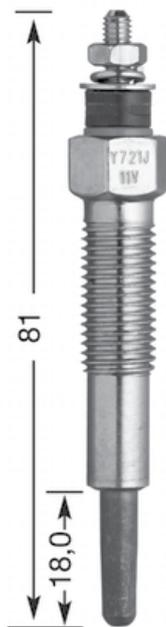

Y-721 J
M 10 x 1.25
12 Hex
11 V

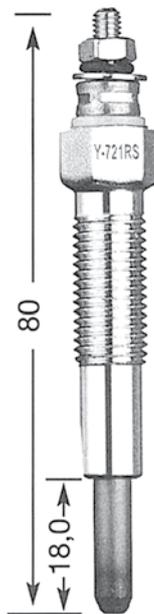

Y-721 RS
M 10 x 1.25
12 Hex
11 V

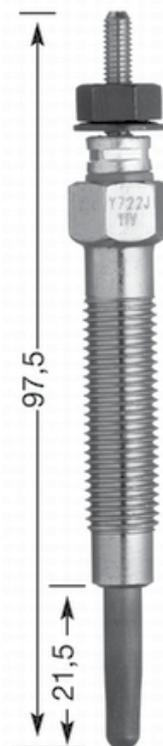

Y-722 J
M 10 x 1.25
12 Hex
11 V

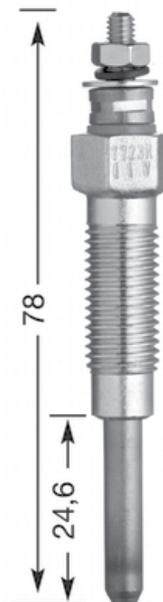

Y-723 R
M 10 x 1.25
12 Hex
11 V

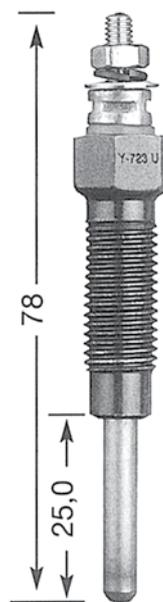

Y-723 U
M 10 x 1.25
12 Hex
8 V

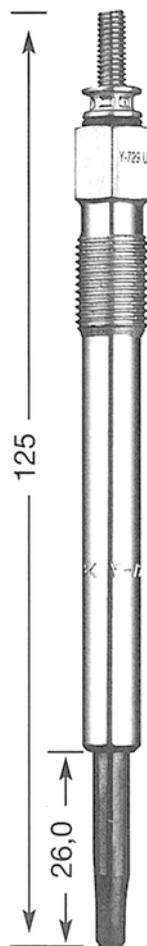

Y-729 U
M 10 x 1
10 Hex
11,5 V

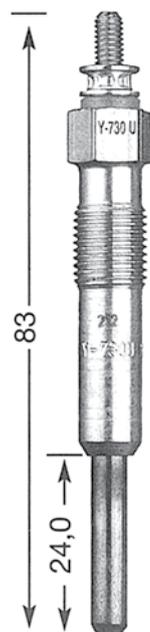

Y-730 U
M 10 x 1.25
12 Hex
11 V

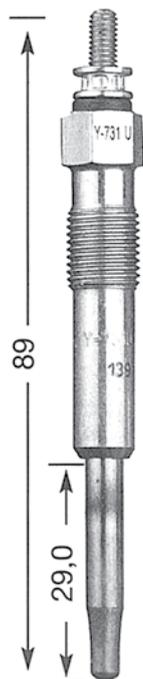

Y-731 U
M 10 x 1.25
12 Hex
11 V

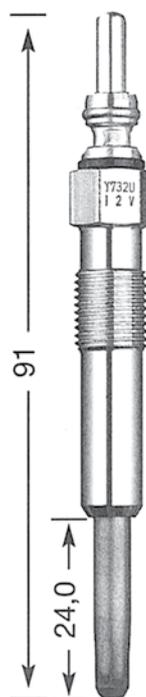

Y-732 U
M 10 x 1.25
12 Hex
8 V

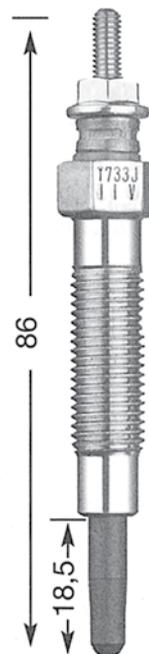

Y-733 J
M 10 x 1.25
12 Hex
11 V

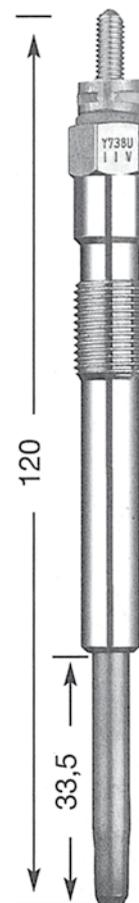

Y-738 U
M 10 x 1
10 Hex
11 V

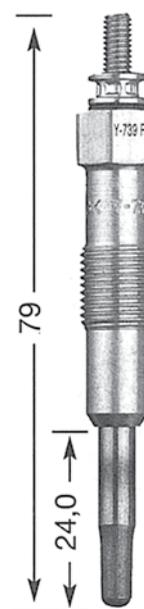

Y-739 R
M 10 x 1
10 Hex
11 V



SERIES OF GLOW PLUG

(ACTUAL SIZE)

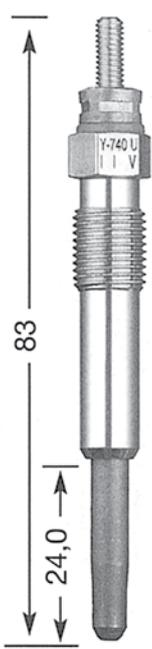

Y-740 U
M 10 x 1
10 Hex
11 V

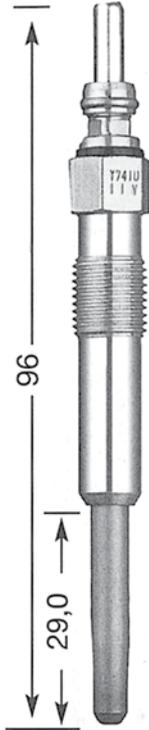

Y-741 U
M 10 x 1
10 Hex
11 V

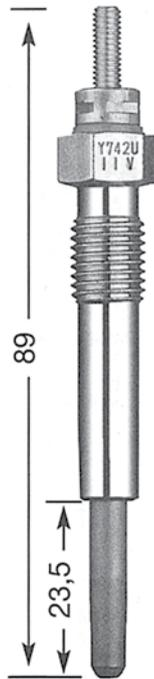

Y-742 U
M 10 x 1.25
12 Hex
11 V

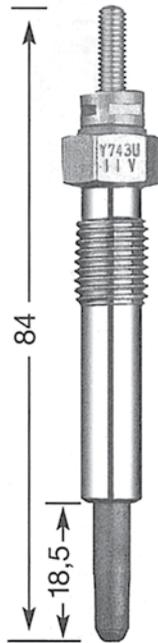

Y-743 U
M 10 x 1.25
12 Hex
11 V

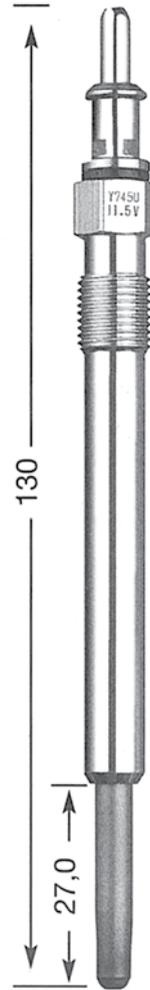

Y-745 U
M 10 x 1
10 Hex
11,5 V



Y-746 J
M 10 x 1
10 Hex
11,5 V

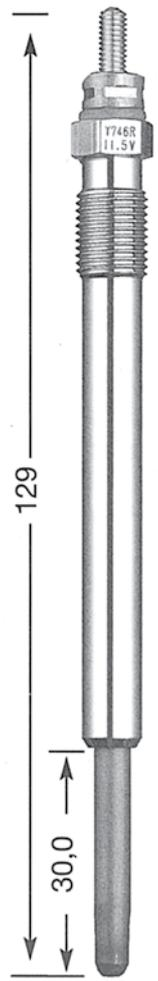

Y-746 R
M 10 x 1
10 Hex
11,5 V

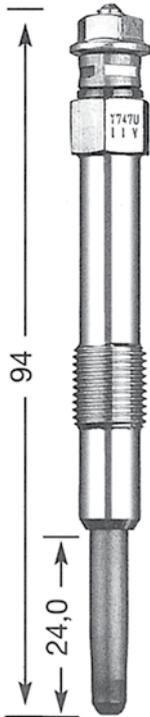

Y-747 U
M 10 x 1
10 Hex
11 V

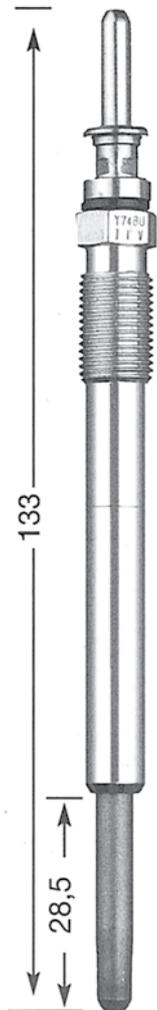

Y-748 U
M 10 x 1
10 Hex
11 V



Y-749 J
M 10 x 1
10 Hex
11 V

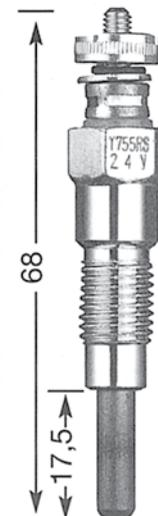

Y-755 RS
M 10 x 1.25
12 Hex
24 V

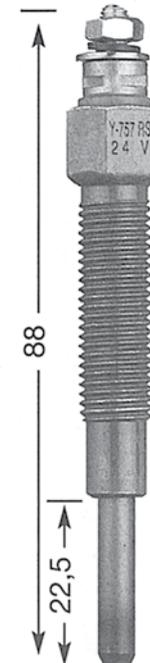

Y-757 RS
M 10 x 1.25
12 Hex
24 V

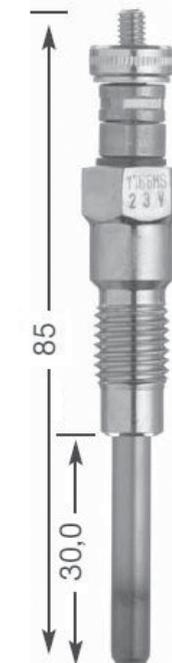

Y-766 MS
M 10 x 1.25
12 Hex
23 V

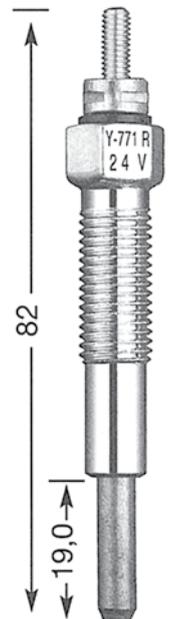

Y-771 R
M 10 x 1.25
12 Hex
24 V



SERIES OF GLOW PLUG

(ACTUAL SIZE)

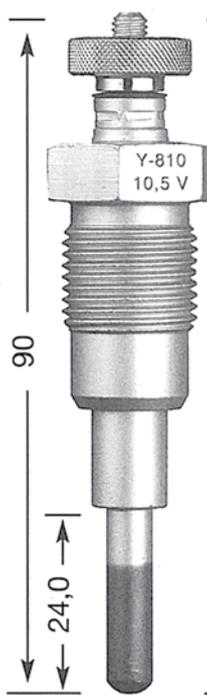
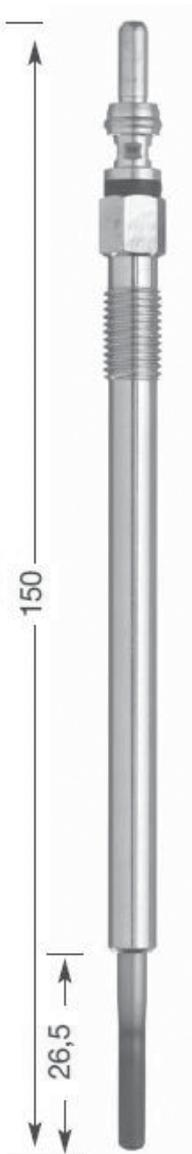

Y-810
M 18 x 1.5
20.6 Hex
10,5 V

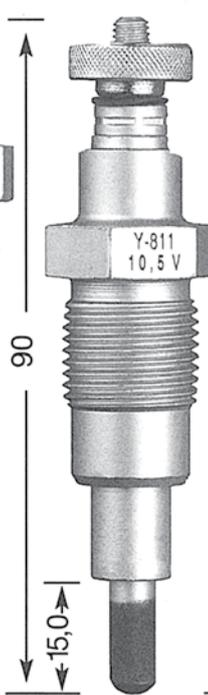

Y-811
M 18 x 1.5
20.6 Hex
10,5 V

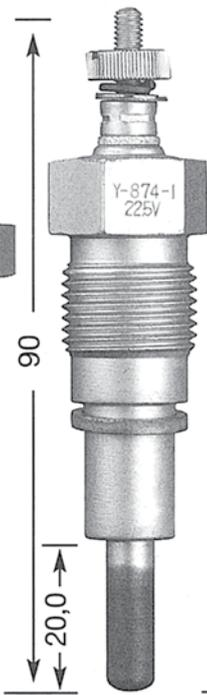

Y-874-1
M 18 x 1.5
19 Hex
22,5 V

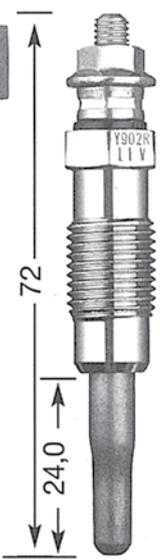

Y-902 R
M 12 x 1.25
12 Hex
11 V

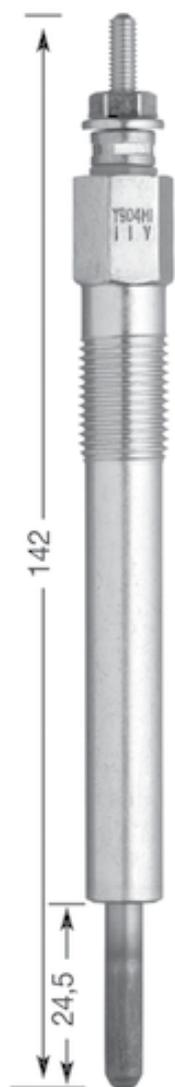

Y-904 M1
M 12 x 1.25
12 Hex
11 V

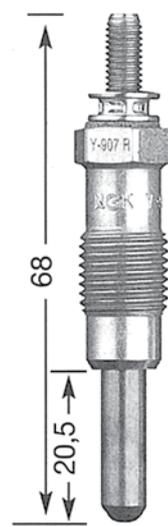

Y-907 R
M 12 x 1.25
12 Hex
11,5 V

Y-8002 AS
M 8 x 1
8 Hex
4,4 V

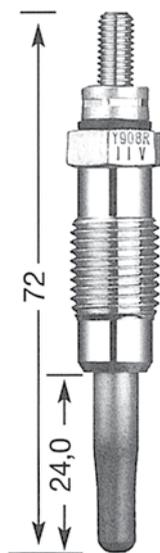

Y-908 R
M 12 x 1.25
12 Hex
11 V

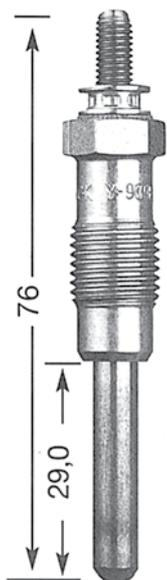

Y-909 R
M 12 x 1.25
12 Hex
11 V



Y-910 J
M 12 x 1.25
12 Hex
11,5 V

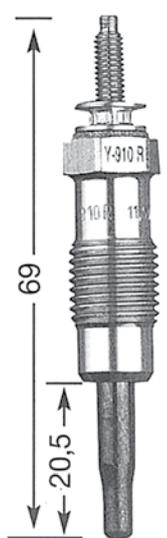

Y-910 R
M 12 x 1.25
12 Hex
11,5 V



Y-911 J
M 12 x 1.25
12 Hex
11 V

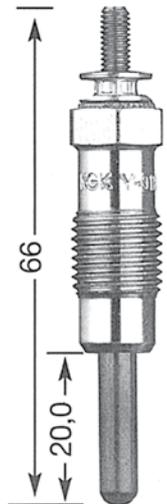

Y-911 R
M 12 x 1.25
12 Hex
11 V

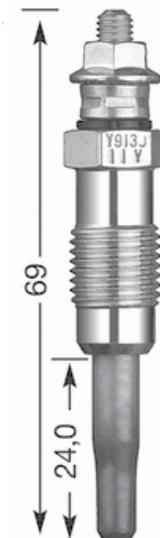

Y-913 J
M 12 x 1.25
12 Hex
11 V



SERIES OF GLOW PLUG

(ACTUAL SIZE)

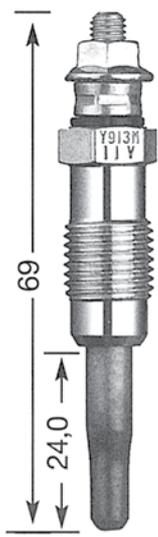

Y-913 M
M 12 x 1.25
12 Hex
11 V

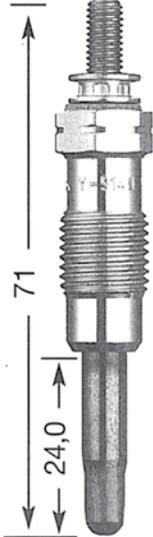

Y-914 U
M 12 x 1.25
12 Hex
11 V

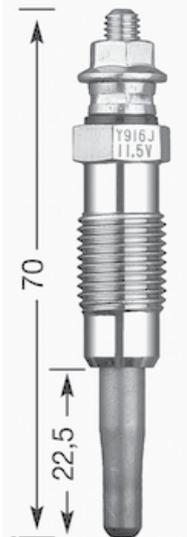

Y-916 J
M 12 x 1.25
12 Hex
11,5 V

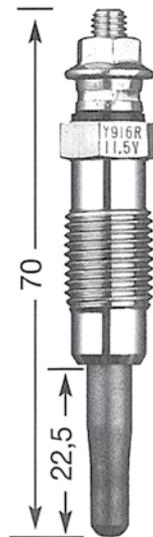

Y-916 R
M 12 x 1.25
12 Hex
11,5 V

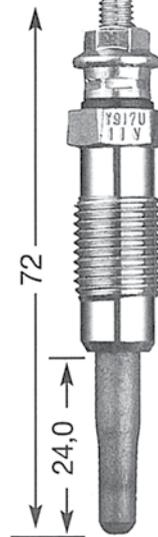

Y-917 U
M 12 x 1.25
12 Hex
11 V

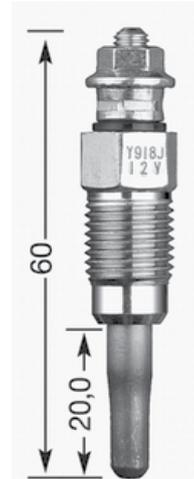

Y-918 J
M 12 x 1.25
12 Hex
11 V

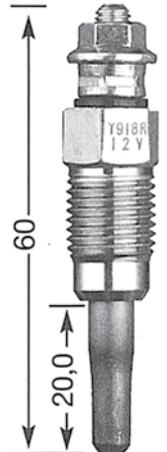

Y-918 R
M 12 x 1.25
12 Hex
11 V

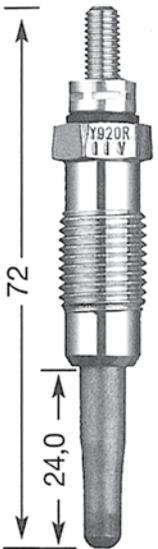

Y-920 R
M 12 x 1.25
12 Hex
11 V

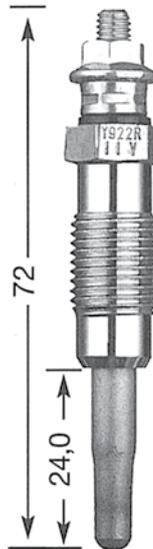

Y-922 R
M 12 x 1.25
12 Hex
11 V

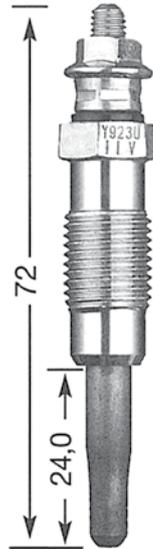

Y-923 U
M 12 x 1.25
12 Hex
11 V

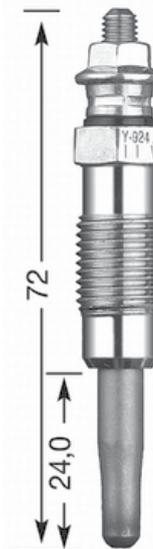

Y-924 J
M 12 x 1.25
12 Hex
11 V

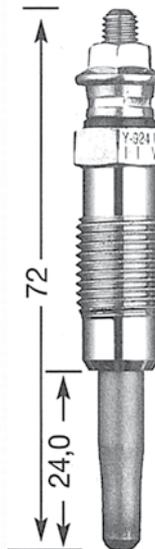

Y-924 R
M 12 x 1.25
12 Hex
11 V



Y-925 J
M 12 x 1.25
12 Hex
11,5 V

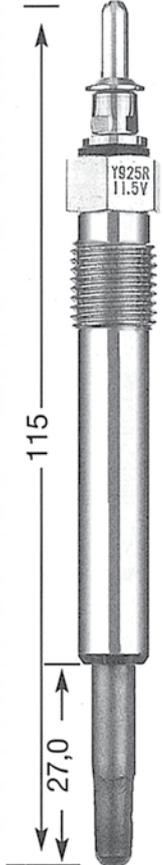

Y-925 R
M 12 x 1.25
12 Hex
11,5 V



SERIES OF GLOW PLUG

(ACTUAL SIZE)

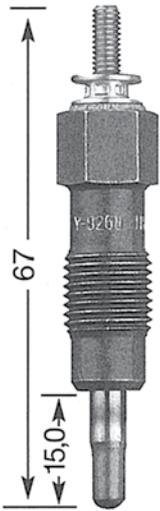

Y-926 U
M 12 x 1.25
12 Hex
11 V

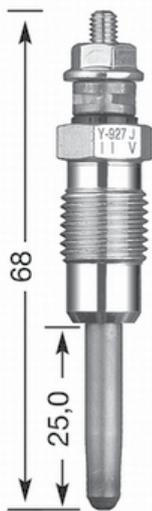

Y-927 J
M 12 x 1.25
12 Hex
11 V

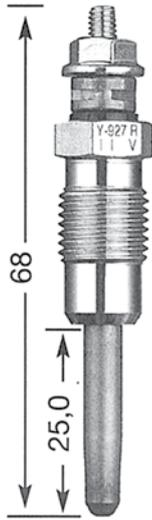

Y-927 R
M 12 x 1.25
12 Hex
11 V

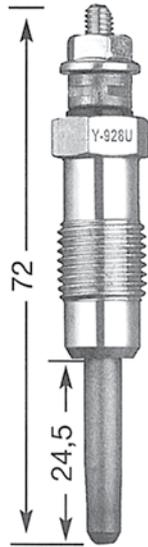

Y-928 U
M 12 x 1.25
12 Hex
11 V

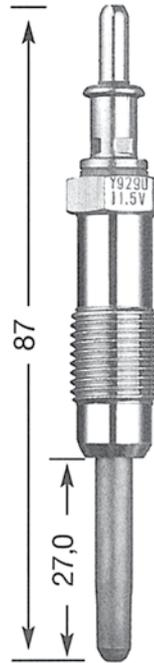

Y-929 U
M 12 x 1.25
12 Hex
11,5 V

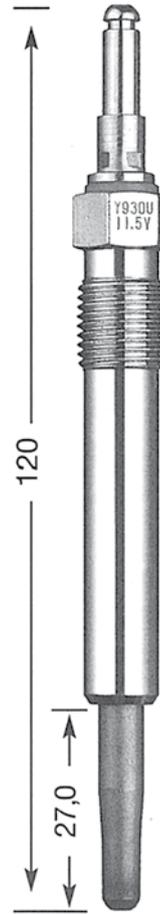

Y-930 U
M 12 x 1.25
12 Hex
11,5 V

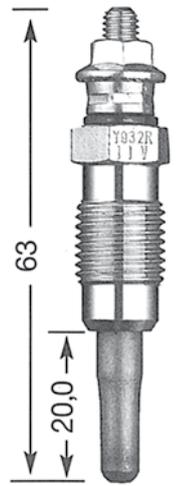

Y-932 R
M 12 x 1.25
12 Hex
11 V

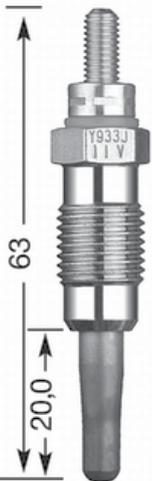

Y-933 J
M 12 x 1.25
12 Hex
11 V

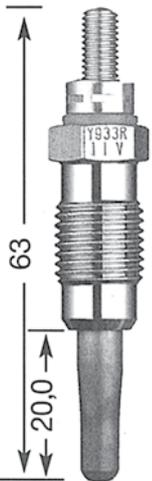

Y-933 R
M 12 x 1.25
12 Hex
11 V

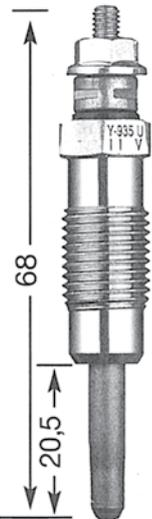

Y-935 U
M 12 x 1.25
12 Hex
11 V

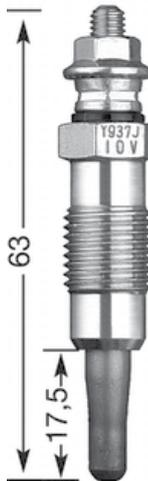

Y-937 J
M 12 x 1.25
12 Hex
10 V

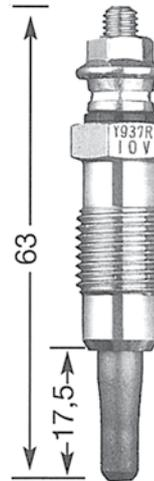

Y-937 R
M 12 x 1.25
12 Hex
10 V

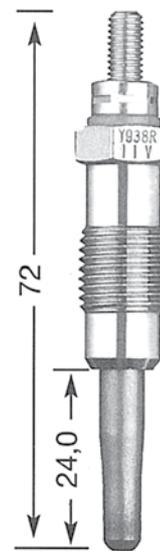

Y-938 R
M 12 x 1.25
12 Hex
11 V



Y-939 J
M 12 x 1.25
12 Hex
11 V



SERIES OF GLOW PLUG

(ACTUAL SIZE)

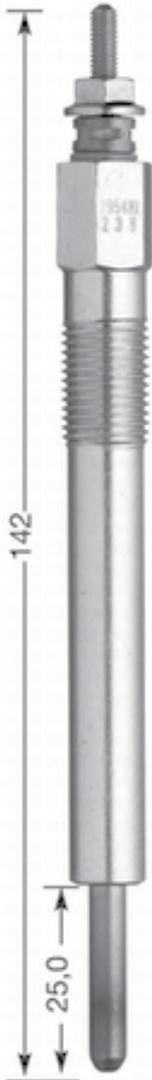

Y-954 M1
M 12 X 1.25
12 Hex
23 V

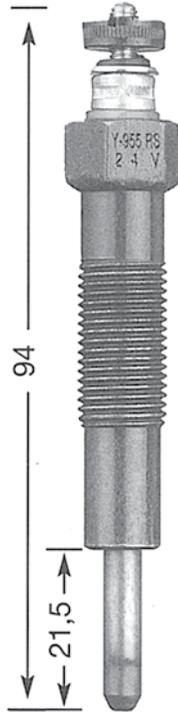

Y-955 RS
M 12 X 1.25
14 Hex
24 V



Y-1010 AS
M10 x 1,0
10 Hex
4,5 V



Y-1045 AS
M10 x 1,0
10 Hex
4,4 V

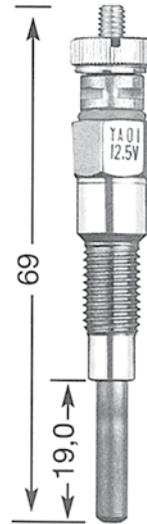

YA 01
M 8 x 1
10 Hex
12,5 V



YE 01
M 8 x 1
10 Hex
11 V



YE 05
M 8 x 1.0
8 Hex
11 V



YE 06
M 8 x 1
8 Hex
11 V

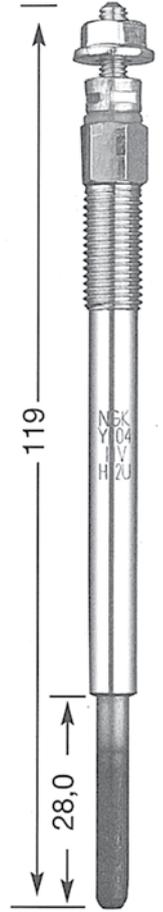

YE 04
M 8 x 1
8 Hex
11 V

SERIES OF GLOW PLUG

(ACTUAL SIZE)

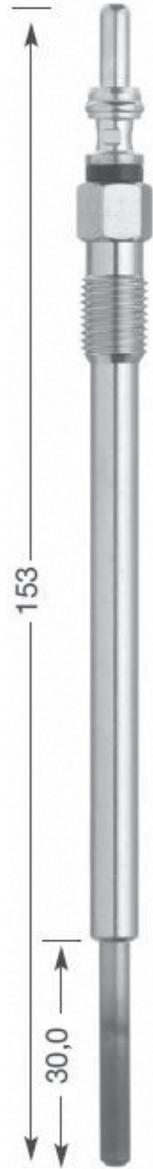

YE 07
M 9 x 1
9 Hex
11 V



YE 08
M 8 X 1
8 Hex
11 V

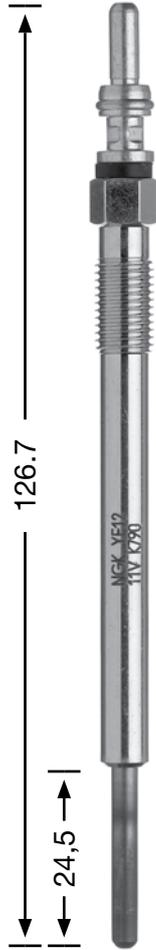

YE 12
M 8 x 1.0
8 Hex
11 V



YE 13
M 8 X 1
8 Hex
11,5 V



YE 14
M 8 X 1
8 Hex
4,4 V

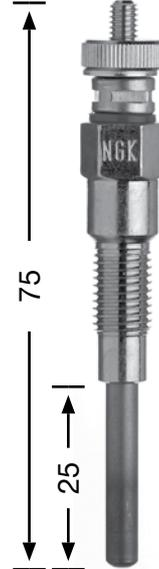

YE 52
M 8 x 1.0
10 Hex
23 V

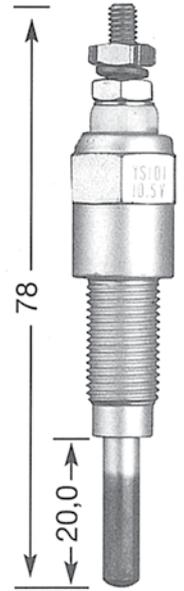

YS 101
M 10 X 1
14 Hex
10,5 V

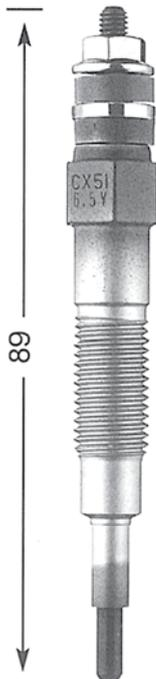

CX 51
M 10 x 1.25
10 Hex
6,5 V

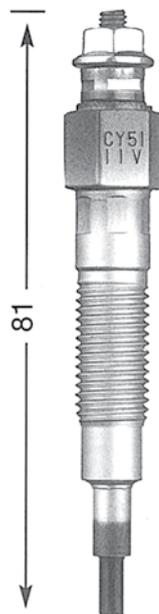

CY 51
M 10 x 1.25
12 Hex
11 V

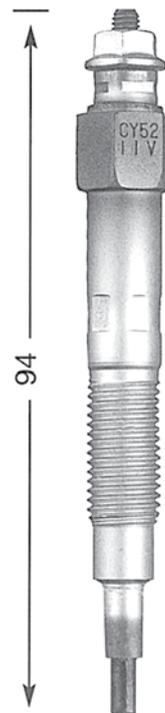

CY 52
M 10 x 1.25
12 Hex
11 V

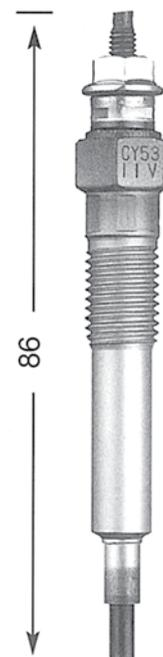

CY 53
M 10 x 1.25
12 Hex
11 V

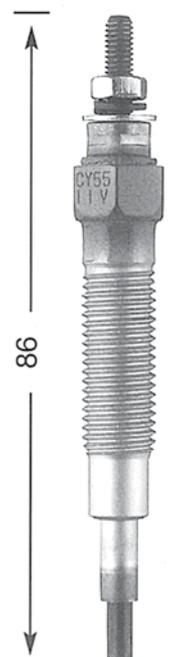

CY 55
M 10 x 1.25
12 Hex
11 V



SERIES OF GLOW PLUG

(ACTUAL SIZE)

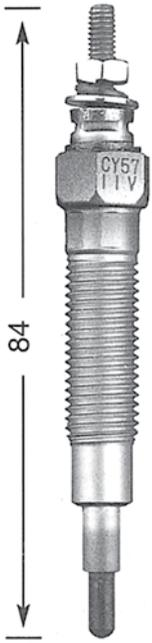

CY 57
M 10 x 1.25
12 Hex
11 V

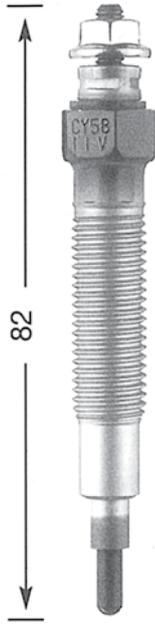

CY 58
M 10 x 1.25
12 Hex
11 V

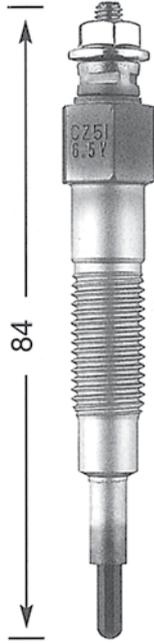

CZ 51
M 10 x 1.25
12 Hex
6,5 V

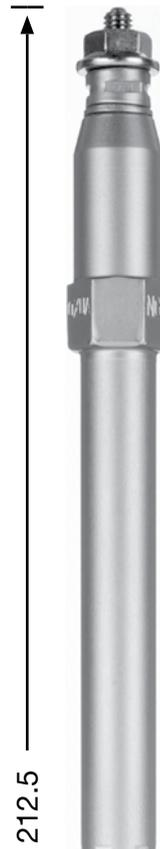

CZ 71
M 10 x 1.25
12 Hex
11 V



CZ 104
M 10 x 1.0
10 Hex
7 V



CZ 105
M 10 x 1.25
10 Hex
7 V

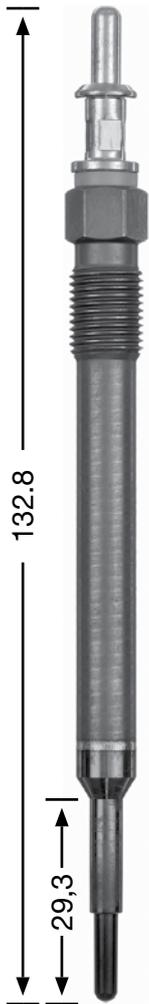

CZ 106
M 10 x 1.0
10 Hex
7 V



CZ 203
M 10 x 1.25
12 Hex
11 V

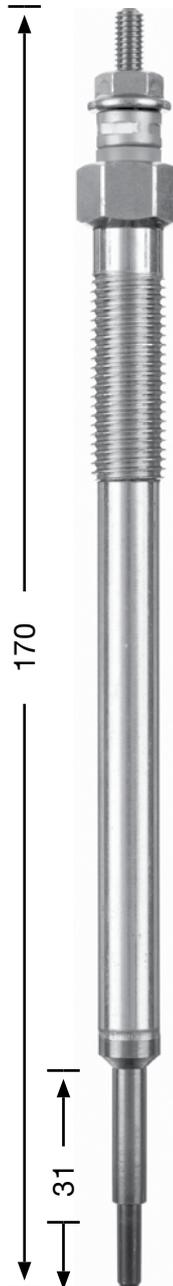

CZ 251
M 10 x 1.25
12 Hex
11 V



CZ 256
M 10 x 1.25
12 Hex
11 V



CZ 258
M 10 x 1.25
12 Hex
11 V



SERIES OF GLOW PLUG

(ACTUAL SIZE)

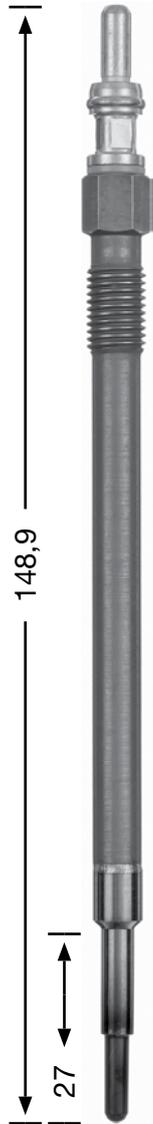

CZ303
M 8 x 1.0
8 Hex
7 V

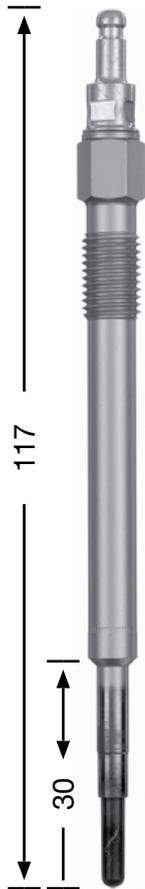

CZ304
M 8 x 1.0
8 Hex
7 V

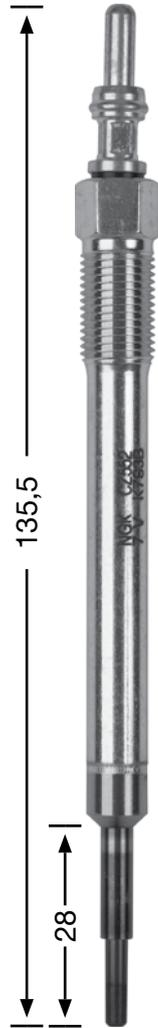

CZ552
M 10 x 1,0
10 Hex
7,0 V

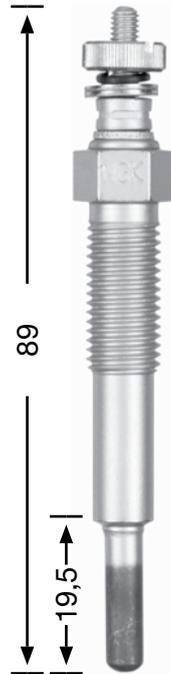

Y-122
M 10 x 1.25
12 Hex
10,5 V

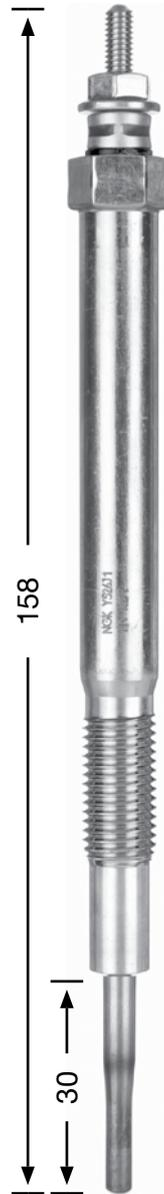

Y-526J1
M 10 x 1.25
12 Hex
11 V

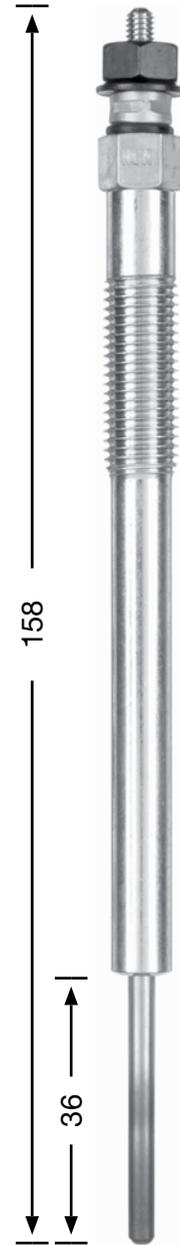

Y-535J
M 10 x 1.25
10 Hex
11 V



Y-536J
M 10 x 1.0
10 Hex
11 V



SERIES OF GLOW PLUG

(ACTUAL SIZE)



Y-537AS
M 10 x 1.0
10 Hex
5 V



Y-548-J
M 10 x 1.0
12 Hex
11,5 V



Y-720U1
M 10 x 1.25
12 Hex
10 V



Y-603J
M 10 x 1.25
12 Hex
11 V

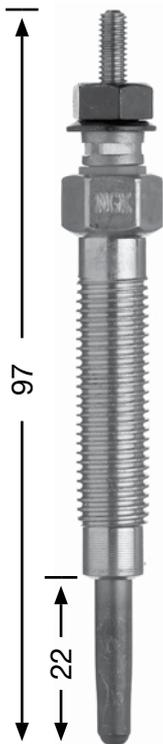

Y-722JS
M 10 x 1.25
12 Hex
11 V

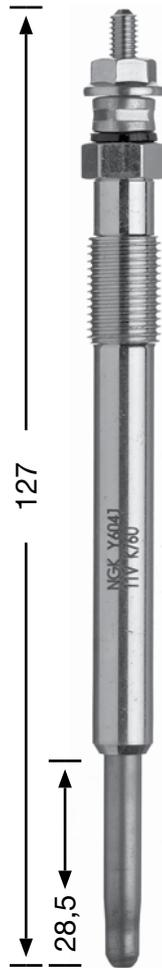

Y-604J
M 10 x 1.0
10 Hex
11 V



Y-732J
M 10 x 1.0
10 Hex
12 V

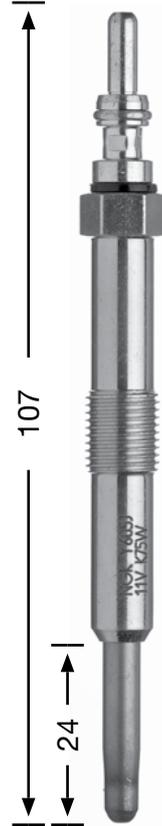

Y-605J
M 10 x 1.0
10 Hex
11 V

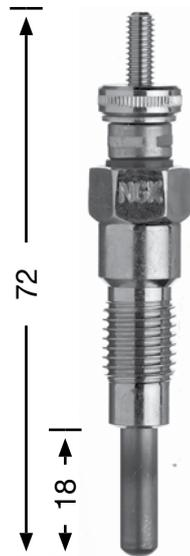

Y-752M
M 10 x 1.25
12 Hex
23 V



Y-703M1
M 10 x 1.25
12 Hex
11 V

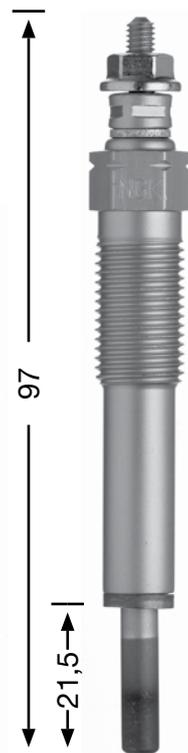

Y-971M
M 10 x 1.25
12 Hex
23 V



Y-719RS1
M 10 x 1.25
12 Hex
11 V



SERIES OF GLOW PLUG

(ACTUAL SIZE)

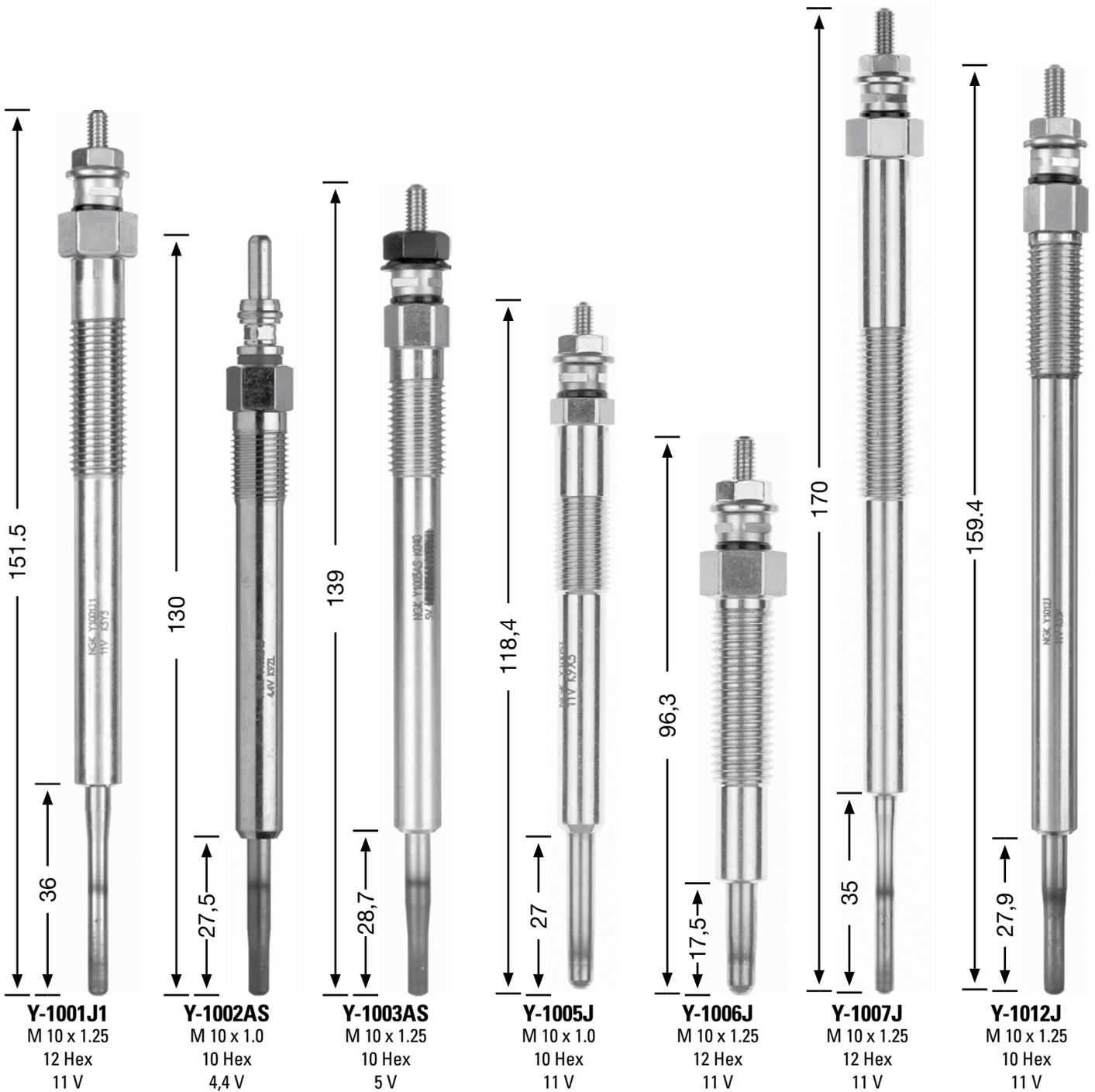



SERIES OF GLOW PLUG

(ACTUAL SIZE)

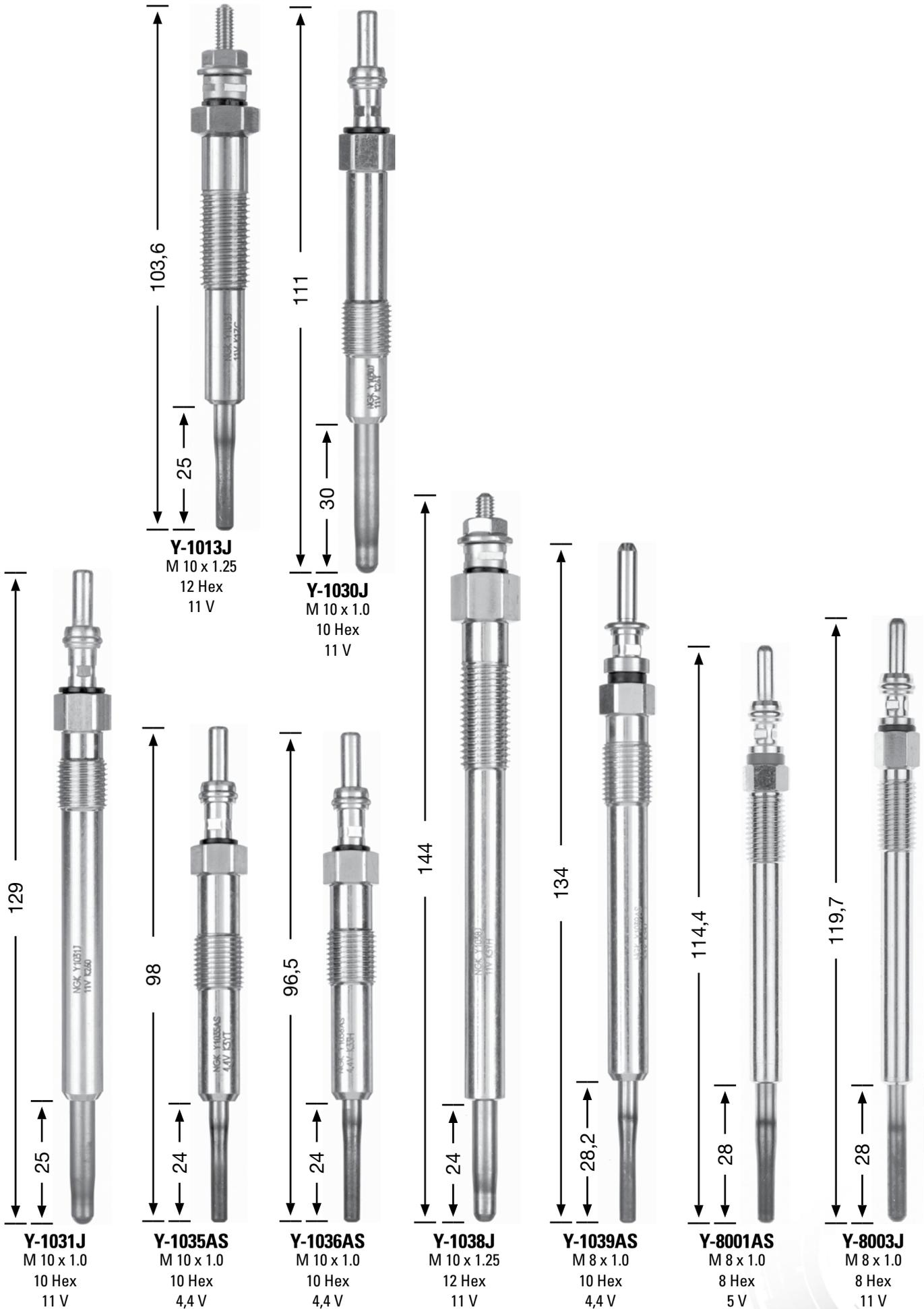



SERIES OF GLOW PLUG

(ACTUAL SIZE)



Y-8005J
M 8 x 1.0
8 Hex
11 V



Y-8008AS
M 8 x 1.0
8 Hex
11 V



Y-8009AS
M 8 x 1.0
8 Hex
4,4 V



Y-9001AS
M 9 x 1.0
9 Hex
4,3 V



Y-9003AS
M 9 x 1.0
9 Hex
4,4 V

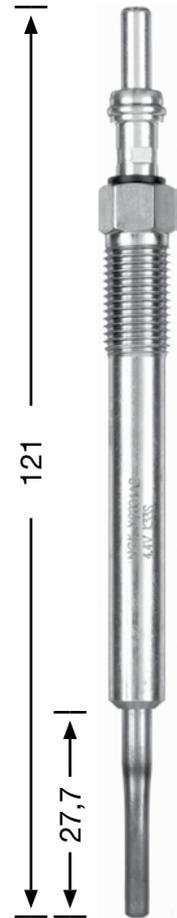

Y-9004AS
M 9 x 1.0
9 Hex
4,4 V





STRUCTURE OF A GLOW PLUG

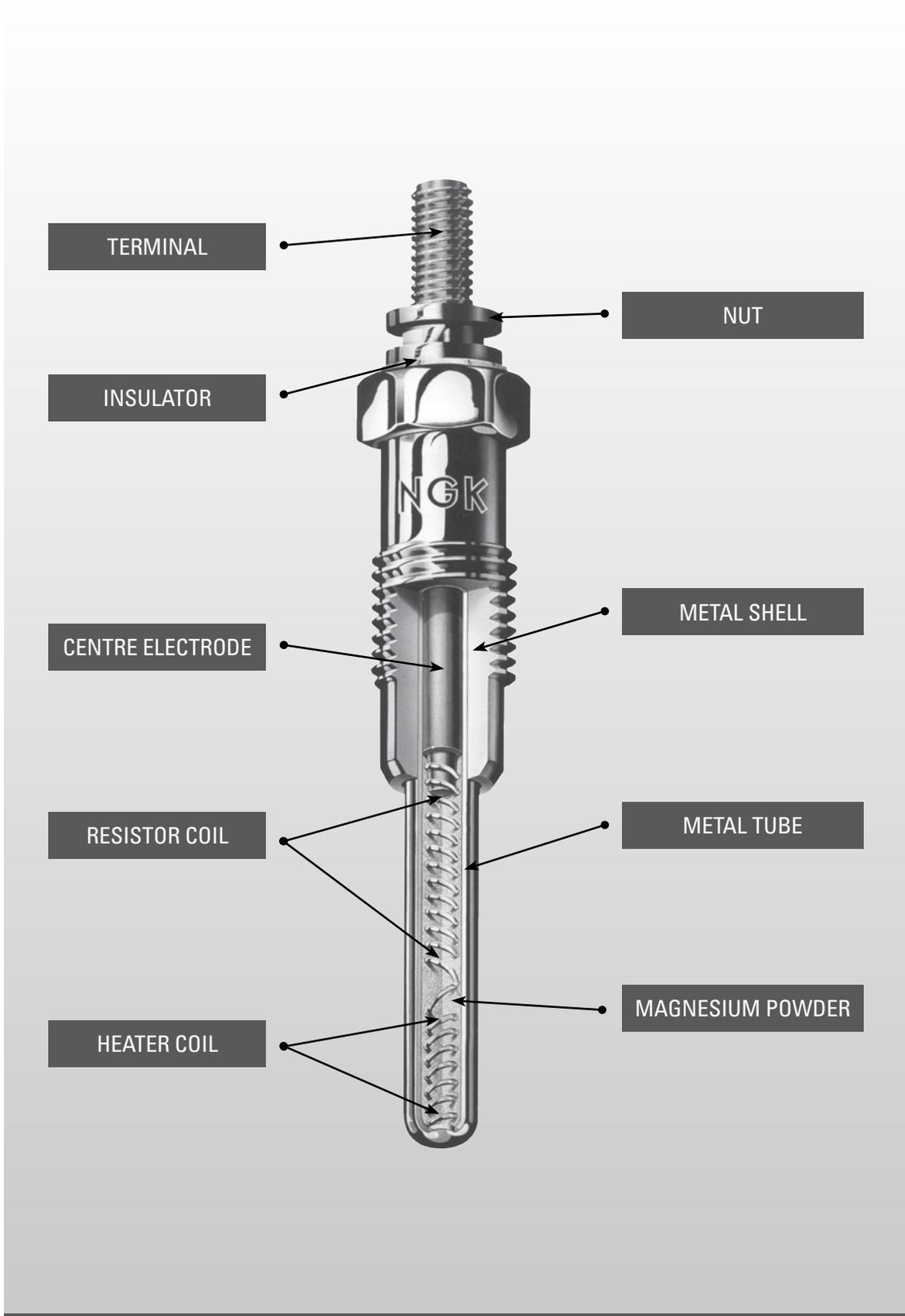

DESIGN SYMBOLS USED IN NGK GLOW PLUGS



Glow plugs are available in many types for different engine models.

[Sheathed Glow Plug] The sheathed glow plug is developed to withstand heavy-duty containing its heating coil in a refractory tube.

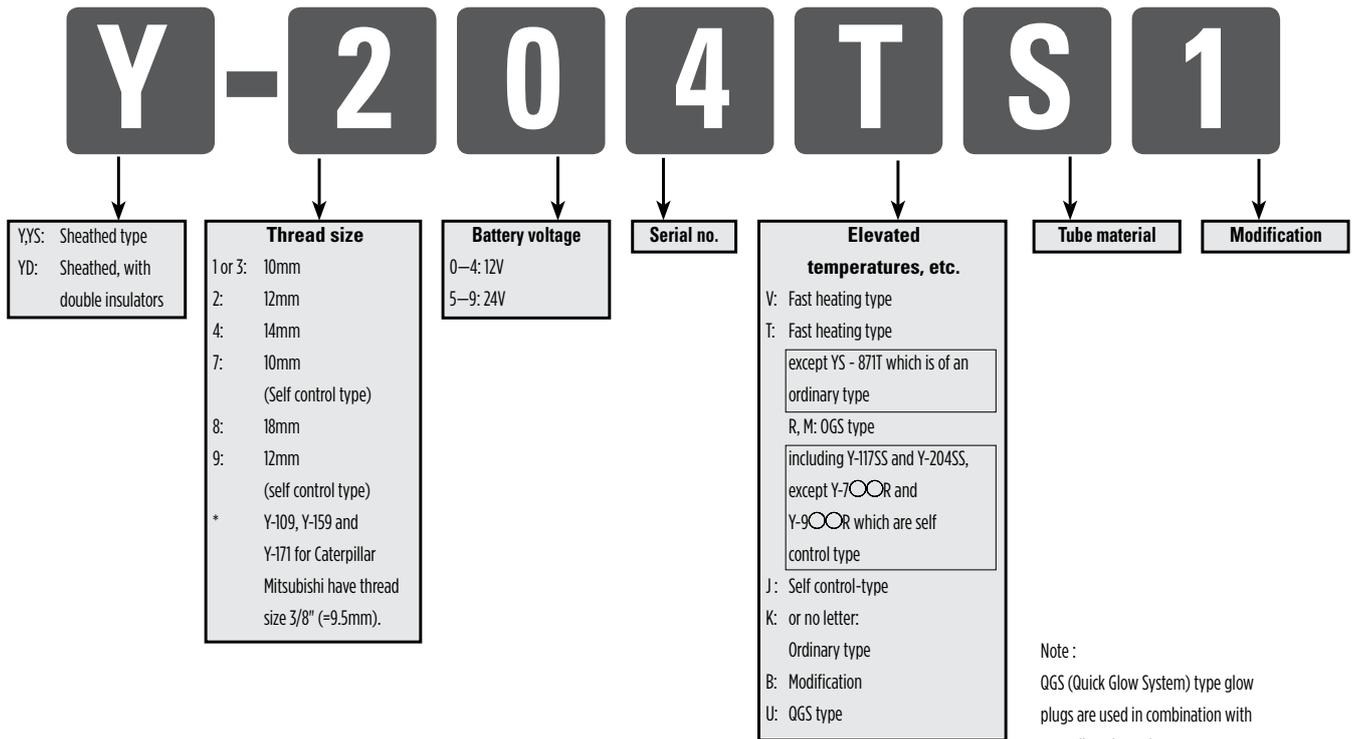

[CERAMIC GLOW PLUG]

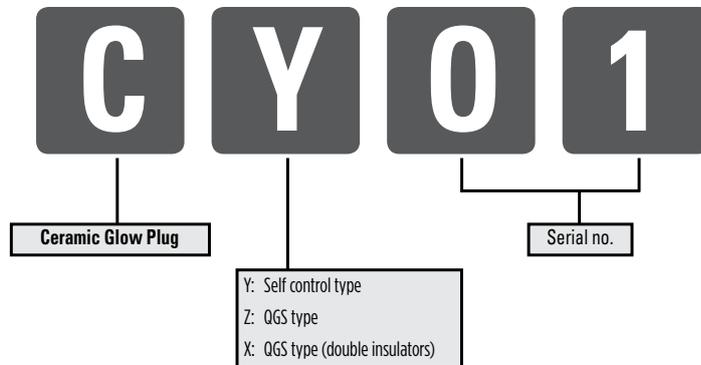



GLOW PLUG TROUBLE TRACING

IN CASE OF POOR STARTING, CHECK THE FOLLOWING:

1. First check the glow signal (glow indicator) on the instrument panel.
 - a) If any sheathed plug is broken, the indicator will take a long time to glow.
 - b) If there is a short-circuit, the indicator will glow quickly and will burn.
2. If uncertain, remove the glow plug for visual checking, measure its resistance with a tester, or apply the rated voltage indicated on its hexagon to check for heating.

(Don't apply battery 12V or 24V directly)

- a) Heating Element Breakage (infinite Resistance or Non Heating)
Before replacing, check to see if the glow plug was wired properly.
Also check with a tester to see if excess voltage has been applied to each glow plug.
Possibly, better to check engine especially for fuel injection timing.
- b) Short-Circuit or Resultant breakage Before replacing, repair any damaged part of the wiring.





GLOW PLUG FAULT FINDING



CAUSES

RECOMMENDED COUNTER MEASURE

Melted Heater Tube

- **ABNORMAL/OVERHEATING**

- a) Incorrect fuel injection timing and volume flow rate
- b) Abnormal combustion due to excessive lubricating oil entering the combustion chamber

- a) Check for injection timing and flow rate
- b) Check valve guides and piston rings

- **EXCESSIVE VOLTAGE**

- a) Incorrect glow plug has been fitted
- b) Faulty controller relay or glow plugs switched on too long

- a) Confirm glow plug part number is correct
- b) Check controller relay operation

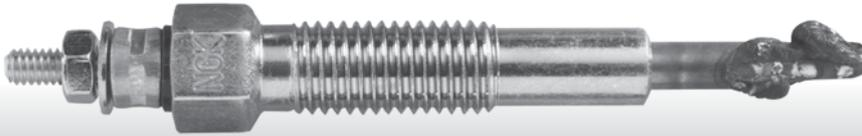

Heating Coil Broken

- Excessive Voltage

- Ensure correct voltage
- Ensure manufactures recommendations / specifications are adhered to



Heater Tube Broken

- Excessive turbulence or overheating due to incorrect fuel injection timing or volume flow rate

- Check fuel injection timing and volume flow rate



WARNING

DO NOT CONNECT BATTERY DIRECTLY TO GLOW PLUG FOR TESTING PURPOSES



NGK SPARK PLUG RESISTOR COVER

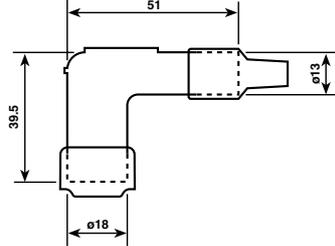
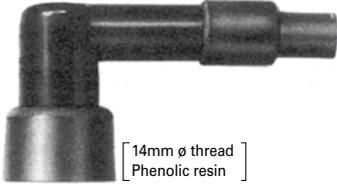
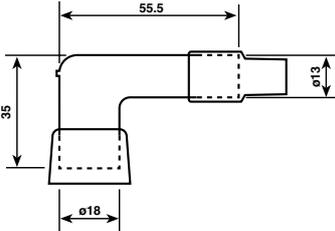
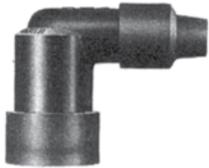
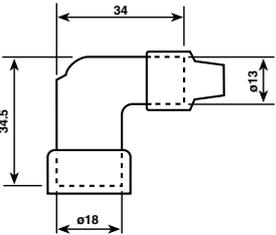
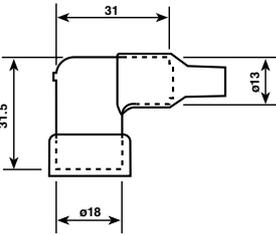
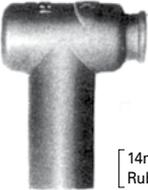
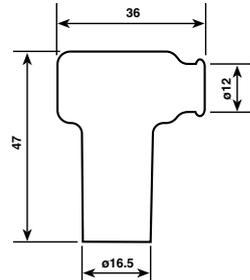
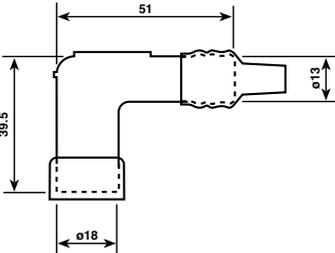

Configuration (application plug thread dia, body material) Unit: mm	Type No.	(KΩ)
 <p>LE, LB type: 14mm ϕ thread LD type: 10 & 12mm ϕ thread Phenolic resin</p> <p><Excluding LBOEZ type></p>  <p>39.5, 51, $\phi 13$, $\phi 18$</p>  <p>14mm ϕ thread Phenolic resin</p> <p><Excluding LBOEZ></p>  <p>55.5, 35, $\phi 13$, $\phi 18$</p>	<p>LBE LBEPK LBOE LBOEP LBOEZ LBOEPK</p> <p>LBF LBOF LBOFP LZO</p>	<p>No resistor No resistor 1,5,10 1,5,10 1,5,10 1,5,10</p> <p>No resistor 1,5,10 1,5,10</p> <p>1,5,10</p>
  <p>34, 34.5, $\phi 13$, $\phi 18$</p>	<p>LZEH LZFH</p>	<p>No resistor</p>
 <p>LB type: 14mm ϕ thread LZ type: 10, 12 & 14mm ϕ thread Phenolic resin</p>  <p>31, 31.5, $\phi 13$, $\phi 18$</p>	<p>LEH LBOEH LBOEHF LBOEHFK LDFH</p>	<p>No resistor 1,5,10 1,5,10 1,5,10 No resistor</p>
 <p>14mm ϕ thread Rubber sheathed</p>  <p>36, 47, $\phi 12$, $\phi 16.5$</p>	<p>LBOEMH</p>	<p>5</p>
 <p>10 & 12mm ϕ thread Phenolic resin</p>  <p>51, 39.5, $\phi 13$, $\phi 18$</p>	<p>LDF LDOF</p>	<p>No resistor 1,5,10</p>



NGK SPARK PLUG RESISTOR COVER

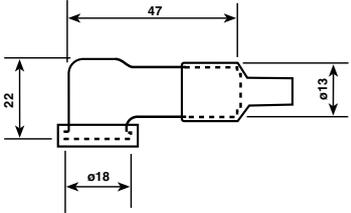
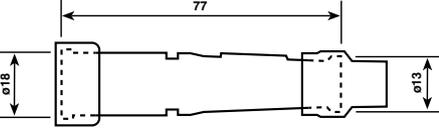
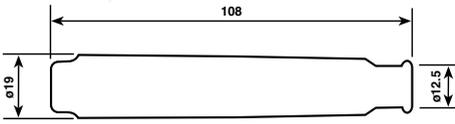
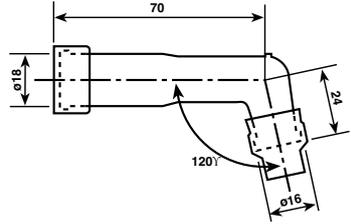
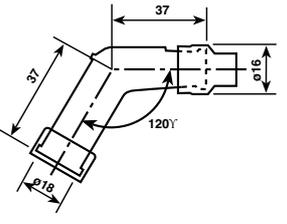
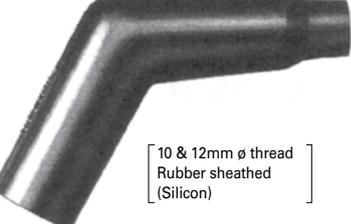
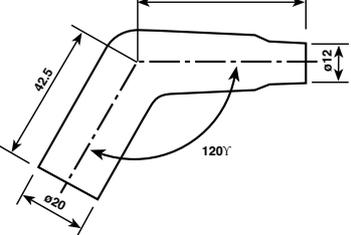
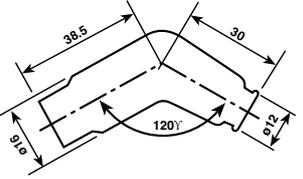

Configuration (application plug thread dia, body material) Unit: mm	Type No.	 (kΩ)
 <p>[10mm ϕ CM-6 only] Phenolic resin</p> 	LCOEFK	1,5,10
 <p>SB type: 14mm ϕ thread SD type: 10 & 12mm ϕ thread SZ type: 10, 12mm & 14mm ϕ thread Phenolic resin</p> 	SBOE SBOF SBOFP SDOF SDOFP SZOF	1,5,10 1,5,10 1,5,10 1,5,10 1,5,10 1,5,10
 <p>[10 & 12mm ϕ thread] Rubber sheathed</p> 	SDOFM	5
 <p>XB type: 14mm ϕ thread XD type: 10 & 12mm ϕ thread XZ type: 10, 12mm & 14mm ϕ thread Phenolic resin</p> 	XBOF XBOFP XDOF XDOFP XZOF	1,5,10 1,5,10 1,5,10 1,5,10 1,5,10
 <p>VB type: 14mm ϕ thread VD type: 10, 12mm ϕ thread Phenolic resin</p> 	VBOE VBF VBOF VBOFP VDOF VDOFP	1,5,10 No resistor 1,5,10 1,5,10 1,5,10 1,5,10
 <p>[10 & 12mm ϕ thread] Rubber sheathed (Silicon)</p> 	VDOFML	5
 <p>[10 & 12mm ϕ thread] Rubber Sheathed</p> 	VDOFMH	5



NGK SPARK PLUG RESISTOR COVER

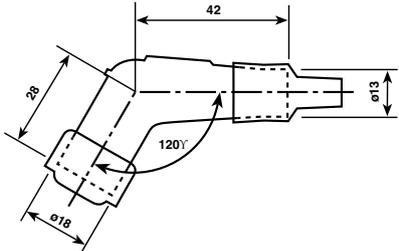
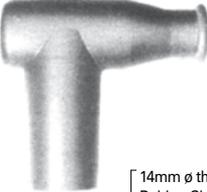
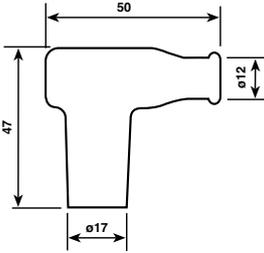
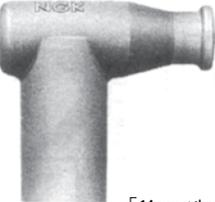
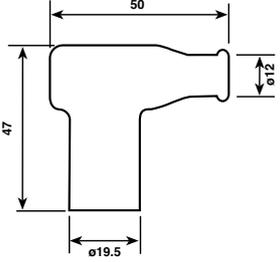
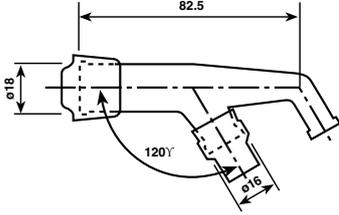
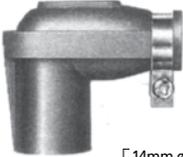
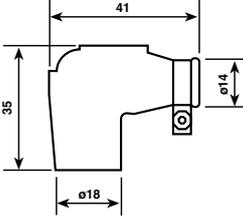
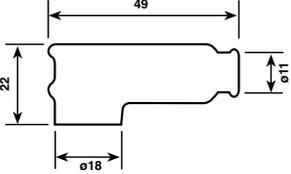

Configuration (application plug thread dia, body material) Unit: mm	Type No.	 (KΩ)
 <p>YB type: 14mm ϕ thread YD type: 10 & 12mm ϕ thread Phenolic resin</p> 	YBϕF YBϕFP YDϕF	1,5,10 5 1,5
 <p>14mm ϕ thread Rubber Sheathed (Silicon)</p> 	TBϕEM	5,10
 <p>14mm ϕ thread Rubber sheathed</p> 	TBϕEMA	5
 <p>14mm ϕ thread Polyester Resin</p> 	VBϕEYK	5
 <p>14mm ϕ thread Rubber Sheathed (Silicon)</p> 	LBER	No resistor
 <p>14mm ϕ thread Rubber Sheathed (Silicon) For racing spark plug R6120ϕ only</p> 	TRS1225	5



NGK SPARK PLUG RESISTOR COVER

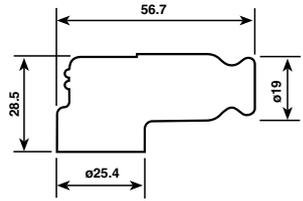

Configuration (application plug thread dia, body material) Unit: mm	Type No.	 (K Ω)
<div style="border: 1px solid black; padding: 5px; width: fit-content;"> <p>14mm ϕ thread Rubber Sheathed (Silicon)</p> <p>For racing spark plug R5300A-ϕ, R5300N-ϕ only</p> </div> <div style="text-align: center; margin-top: 20px;">  </div>	TRS1408F	5

SYMBOL EXPLANATION

L B 05 E H P K

External appearance	
L	90° Elbow type
S	Straight
X	102° Elboe type
V	120° Elbow type (long)
Y	120° Elboe type (short)

Resistance	
01	1K Ω
05	5K Ω
10	10K Ω

Adaptable plug thread size	
B	14mm ϕ thread
D	10 & 12mm ϕ thread
Z	10, 12 & 14mm ϕ thread

Adaptable plug terminal	
E	For terminal nut or integrated terminal
F	For terminal stud

Accessory	
H	Compact type
P	With special waterproof cover
K	With silicon waterproof cover
S	Metal shielded
M	Rubber sheathed
G	With rubber grommet
W	Double connector springs
F	For 5mm ϕ high tension cord
L	Wire wound resistance
Y	With handle
Z	Special shape



SERIES OF NGK SPARK PLUGS



I STANDARD TYPES

	NON-RESISTOR	RESISTOR
14mm ϕ \times 9.5mm 20.8 Hex Fig. ①①	B-2 B-4 B6S B7S B8S	BR6S
Fig. ①③	BP-4 BP5S BP6S	
14mm ϕ \times 19.0mm 20.8 Hex Fig. ②①	B4ES B5ES B6ES,-11 B7ES,-11 B8ES B9ES B10ES	BR4ES BR5ES BR6ES,-11 BR7ES BR8ES,-11 BR9ES BR10ES
Fig. ②②		BR6EB-L-11
Fig. ②④		BR8EYA BR9EYA BR10EYA
Fig. ②⑤	BP2ES, BP-2E BP4ES,-11 BP4ES-L-11 BP5ES,-11,-13 BP6ES,-11 BP7ES,-11 BP8ES BP9ES	BP5ESZ BP6ESZ BPR2ES, BPR-2E BPR4ES,-11,-13 BPR5ES,-11,-13 BPR6ES,-11,-13 BPR7ES,-11 BPR8ES BPR9ES
Fig. ②⑥		BPR5EA BPR5EA-L,-11
Fig. ③①		BPR6EKN BPR7EKN
Fig. ②⑦	BP4EY,-11 BP5EY,-11 BP6EY,-11 BP7EY	BPR4EY,-11 BPR5EY,-11 BPR6EY,-11 BPR7EY,-11
Fig. ②⑧	BP5E BP6E	BPR4E,-11 BPR5E,-11 BPR6E,-11 BPR7E
Fig. ④②	BP5ET,-10 BP6ET BP7ET	
Fig. ⑤①		BPR5EJ
14mm ϕ \times 19.0mm 16.0 Hex Fig. ⑥③	BCP4ES,-11 BCP5ES,-11 BCP6ES,-11 BCP7ES,-11	BCPR4ES-11 BCPR5ES,-11 BCPR6ES,-11 BCPR7ES,-11 BCPR9ES-11
Fig. ⑧② ISO	BCP5ET BCP6ET BCP7ET	BCPR5ET BCPR6ET BCPR7ET
Fig. ⑥①	BC6ES	BCR8ES
Fig. ⑦③ ISO	BK5ES BK5ESZ	BKR4ES-11 BKR5ES,-11 BKR6ES,-11 BKR7ES-11

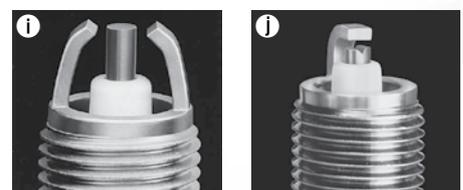
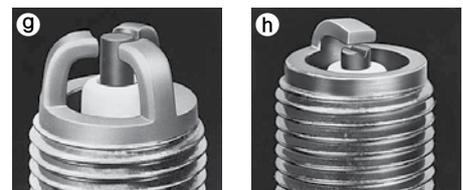
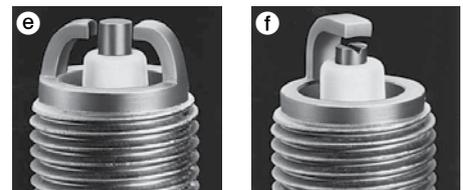
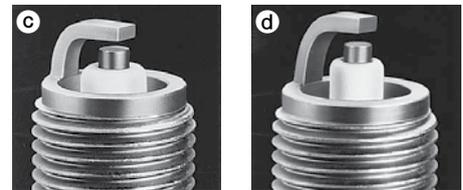
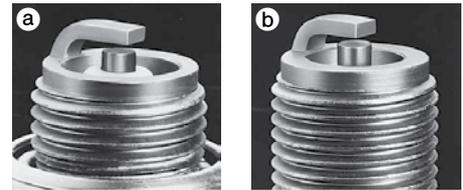
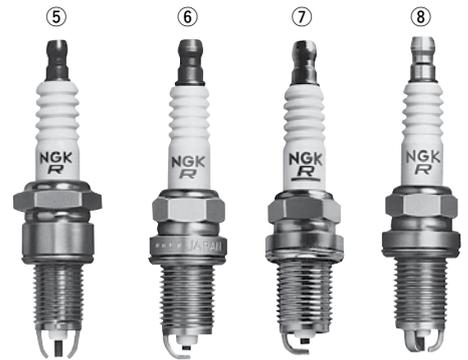
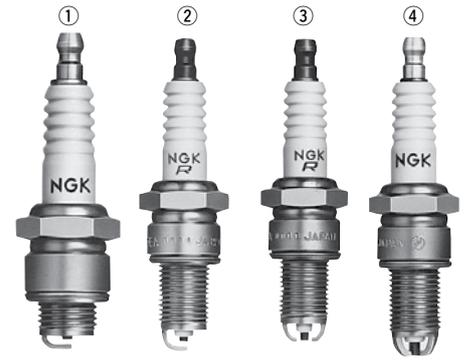



SERIES OF NGK SPARK PLUGS



	NON-RESISTOR	RESISTOR
14mm ϕ × 19.0mm 16.0 Hex Fig. ① ③	BCP5EY-11	BCPR4EY-11 BCPR5EY,-11,-N-11 BCPR6EY,-11,-N-11 BCPR7EY,-11,-N-11
Fig. ② ③ ISO		BKR4EY,-11 BKR5EY,-11 BKR5EYA,-11 BKR6EY,-11 BKR6EYA,-11 BKR7EY
Fig. ① ④	BCP5E,-11 BCP6E,-11 BCP7E,-11	BCPR5E,-11 BCPR6E,-11 BCPR7E,-11
Fig. ② ④ ISO	BK5E,-11 BK6E,-11	BKR4E,-11 BKR5E,-11,-N,-N-11 BKR5EZ BKR6E,-11,-N,-N-11 BKR6EZ BKR7E,-11,-N-11 BKR8E-11
Fig. ⑥ ⑦ ISO		BKR5EK BKR6EK
Fig. ⑥ ⑨ ISO		BKR5EKB-11 BKR6EKB-11 BKR5EKC BKR6EKC,-N-11 BKR6EKE BKR7EKC,-N,-N-11
14mm ϕ × 26.5mm 16.0 Hex Fig. ⑧ ④		LFR4A,-11 LFR5A,-11 LFR6A,-11
14mm ϕ × 11.2mm Conical seat 16.0 Hex Fig. ③ ①	B7FS	BR5FS BR6FS,-15
Fig. ③ ②	BP4FS BP5FS BP6FS BP7FS	BPR4FS,-11,-15 BPR5FS,-11,-15 BPR6FS
Fig. ③ ④	BP5F BP6F	
14mm ϕ × 17.5mm Conical seat 16.0 Hex Fig. ④ ①	B6EFS B8EFS B9EFS	BR7EFS
Fig. ④ ⑤		BR6EF BR7EF
Fig. ④ ②	BP4EFS BP5EFS,-13 BP6EFS,-13 BP7EFS	BPR5EFS,-13 BPR6EFS,-13,-15 BPR7EFS-15
Fig. ④ ④	BP6EF	BPR6EF,-11,-13
14mm ϕ × 25.0mm Conical seat 16.0 Hex Fig. ⑦ ②		TR5A-13 TR5B-13 TR6B-10,-13
14mm ϕ × 11.2mm 20.8 Hex Fig. ⑤ ①	B-4L B-6L B6LY(Fig. ⑤ ⑤)	

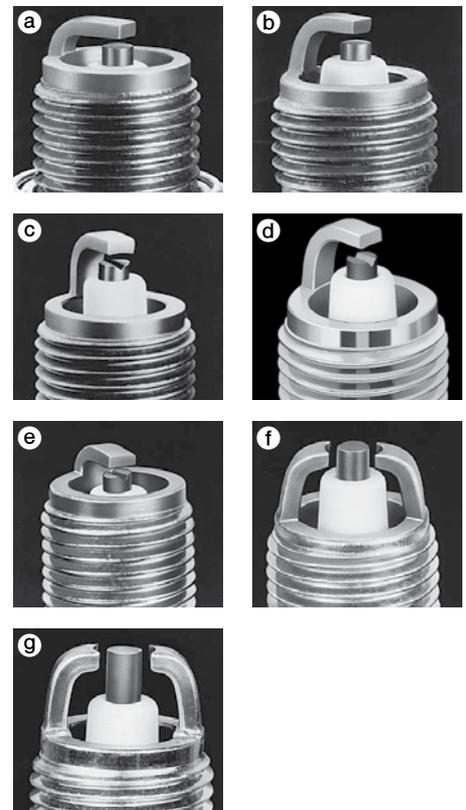



SERIES OF NGK SPARK PLUGS



	NON-RESISTOR	RESISTOR
14mm ϕ × 12.7mm 20.8 Hex Fig. ①(a)	B-2H B-4H,-10 B5HS B6HS,-10 B7HS,-10 B8HS,-10 B9HS,-10 B10HS	BR4HS BR5HS BR6HS,-10 BR7HS,-10 BZ7HS-10 BR8HS,-10 BR9HS,-10
Fig. ①(b)	BP2HS,-10 BP4HSA BP-2H BP-4H BP4HS,-10 BP4HSA BP5HS,-10 BP6HS,-10 BP6HSA BP6H BP7HS,-10 BP7H BP8HS,-10,-15 BP8HSA	BPR2HS BPR4HS,-10 BPR4HSA BPR-4H BPR5HS BPR6HS,-10 BPR6HSA BPR7HS,-10 BPR8HS,-10 BPR8HSA BPZ8HS-10,-15
Fig. ①(c)	BP4HA BP5HA	
Fig. ①(e)	B6HSA B8HSA	BR4HSA,-9 BR6HSA,-9 BR8HSA,-9
18mm ϕ × 10.9mm Conical seat 20.8 Hex Fig. ④(f)	A6FS A7FS A8FS A9FS	AR6FS
Fig. ④(g)	AP4FS AP5FS AP6FS AP7FS AP8FS AP9FS	APR5FS APR6FS
Fig. ④(i)	AP6F	APR6F
18mm ϕ × 12.0mm 20.8 Hex Fig. ⑤(f)	AB-2 AB-6 AB-7 AB-8	
12mm ϕ × 19.0mm 18.0 Hex Fig. ⑥(h)	D6EA D7EA D8EA D9EA D10EA	DR7EA DR7EB DR8EA DR8EB DR9EA
Fig. ⑥(i)	DP6EA-9 DP7EA-9 DP8EA-9 DP9EA-9	DPR5EA-9 DPR6EA-9 DPR6EB-9 DPR7EA-9 DPR8EA-9 DPR9EA-9
Fig. ⑥(h)	J9A	JR8B JR9B JR10B
Fig. ⑥(k)		JR8C JR9C
12mm ϕ × 21.0mm 18.0 Hex Fig. ⑦(i)	DP8Z	DPR7Z DPR8Z DPR9Z
12mm ϕ × 19.0mm 16.0 Hex Fig. ⑧(i)	DCP6E DCP7E	DCPR6E DCPR7E DCPR7E-N DCPR8E DCPR8E-N DCPR9E
Fig. ⑧(m)		DCPR8EKC
12mm ϕ × 26.5mm 14.0 Hex		LKAR8A-9,9S

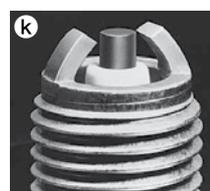
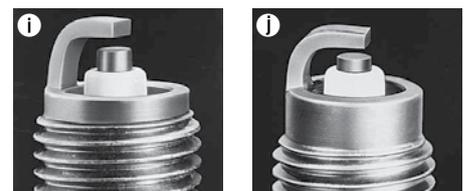
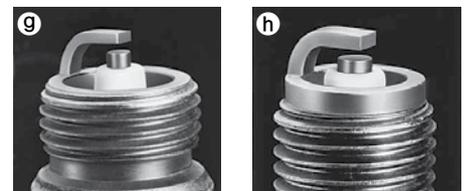
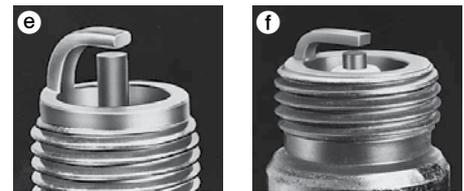
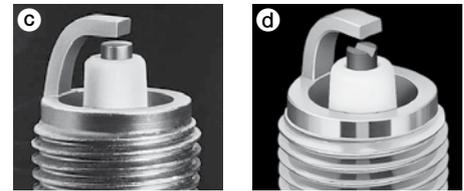
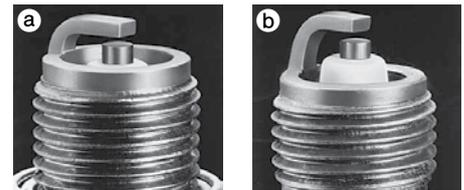



SERIES OF NGK SPARK PLUGS



	NON-RESISTOR	RESISTOR
12mm ϕ × 12.7mm 18.0 Hex Fig. ① a	D6HA D8HA	DR4HS DR5HS DR6HS DR8HS
10mm ϕ × 12.7mm 16.0 Hex Fig. ② a	C2H C5HSA C6HSA C7HSA C8HSA	C4HSB C5HSB CR4HSA CR5HSA CR6HSA CR7HSA CR8HSA CR4HSB CR5HSB LR8A
10mm ϕ × 19.0mm 16.0 Hex Fig. ③ j	C7E C8E C9E	CR6E CR7E CR8E CR9E CR10E CR7EB CR8EB CR9EB
Fig. ③ k		CPR8E CPR7EA-9
10mm ϕ × 19.0mm 16.0 Hex Fig. ④ a	C7EH-9 C8EH-9 C9EH-9	CR7EH-9 CR8EH-9 CR9EH-9 CR10EH-9
10mm ϕ × 19.0mm 16.0 Hex Fig. ③ b		CR7EK CR7EKB CR8EK CR8EKB CR9EK CR9EKB CR10EK
Fig. ③ i		CR7EKC
10mm ϕ × 19.0mm 14.0 Hex		MAR10A-J
10mm ϕ × 26.5mm 14.0 Hex		LMAR6A-9 LMAR6C-9 LMAR7A-9 LMAR8A-9,9S
8mm ϕ × 19.0mm 13.0 Hex Fig. ⑤ a		ER8EH ER9EH ER10EH

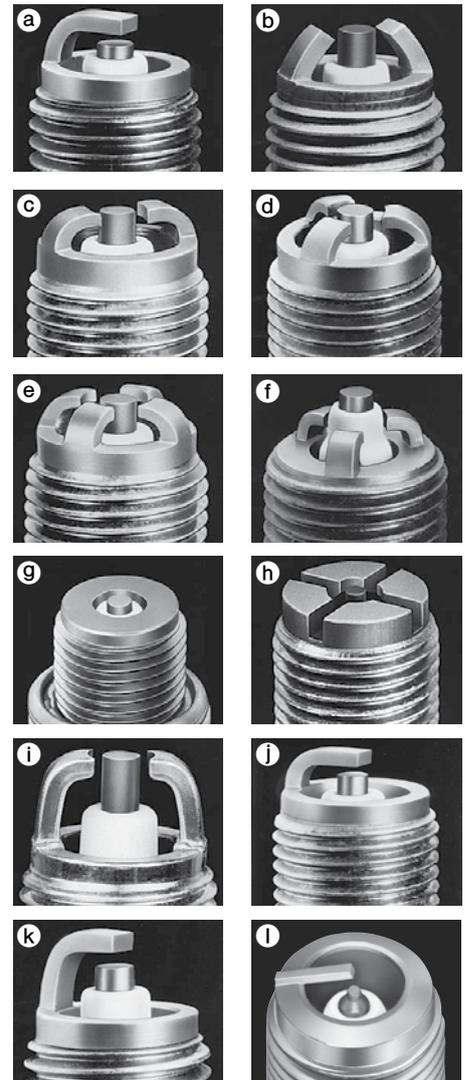
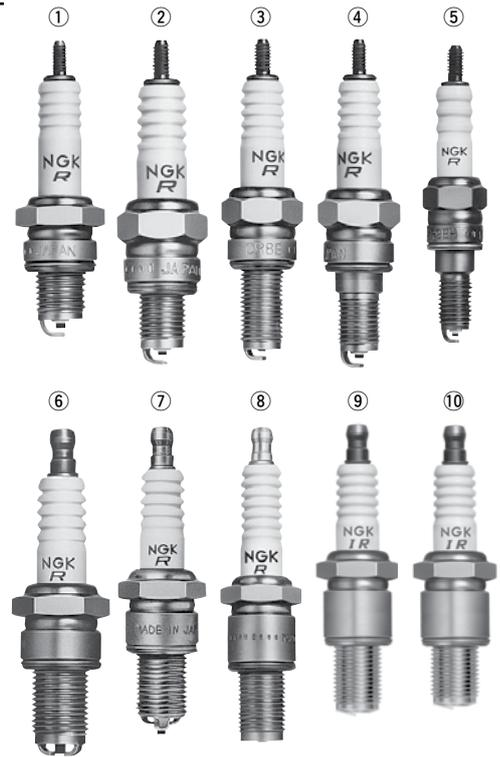

FOR ROTARY ENGINE

	NON-RESISTOR	RESISTOR
14mm ϕ × 19.5mm 20.8 Hex Fig. ⑥ c	B7EM	BR8EM
Fig. ⑥ d		BR7ET BR8ET BR9ET BR10ET
Fig. ⑥ e		BR7EQ-14 BR8EQ-14 BR9EQ-14
14mm ϕ × 21.5mm 20.8 Hex Fig. ⑧ g		SD10A SD11A
Fig. ⑧ h		BUR6EQ BUR7EQP BUR7EQ BUR8EQ BUR8EQ BUR9EQP BUR9EQ BUR9EQP
14mm ϕ × 21.0mm 20.8 Hex Fig. ⑨		RE6C-L RE7C-L RE8C-L
14mm ϕ × 19.0mm 20.8 Hex Fig. ⑩ i		RE9B-T



SERIES OF NGK SPARK PLUGS



SEMI SURFACE DISCHARGE TYPES

	NON-RESISTOR	RESISTOR
14mm ϕ × 12.7mm 20.8 Hex Fig. ①a	BU8H	BUZ8H
14mm ϕ × 19.0mm 20.8 Hex Fig. ②b	BU6EA-11	BUR5EA-11 BUR6EA-11 BUR7EA-11
14mm ϕ × 19.0mm 20.8 Hex Fig. ②c		BUR4EB-11 BUR5EB-11 BUR6EB-11 BUR7EB-11
Fig. ②d		BUR5ET,-10 BUR6ET
14mm ϕ × 19.0mm 20.8 Hex Fig. ③e	BP5EK-A BP6EK-A	BPR5EK-A BPR6EK-A
Fig. ③f		BPR5EKU
14mm ϕ × 17.5mm Conical seat 16.0 Hex Fig. ④g	BU6EFSZ	BUR6EFSZ
14mm ϕ × 19.0mm 16.0 Hex Fig. ⑥e ISO		BKUR6EK,-9 BKUR7EK
Fig. ⑤d ISO		BKUR5ET,-10 BKUR5ETZ,-10 BKUR6ET,-10 BKUR6ETB BKUR7ET
Fig. ⑥f ISO	BK7EKU	BKR5EKU BKR6EKU BKR7EKU
Fig. ⑥h ISO		BKR6EKUE
Fig. ⑥h ISO		BKR6EKUB
14mm ϕ × 22.0mm 16.0 Hex Fig. ⑦i		BKR5EKUC BKR6EKUC
14mm ϕ × 19.0mm 16.0 Hex Fig. ⑥j		BKR6EQUA

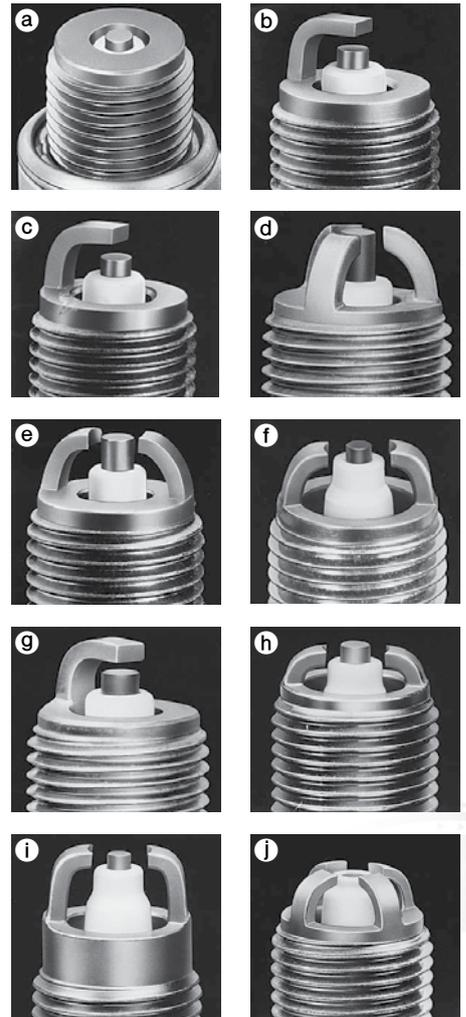
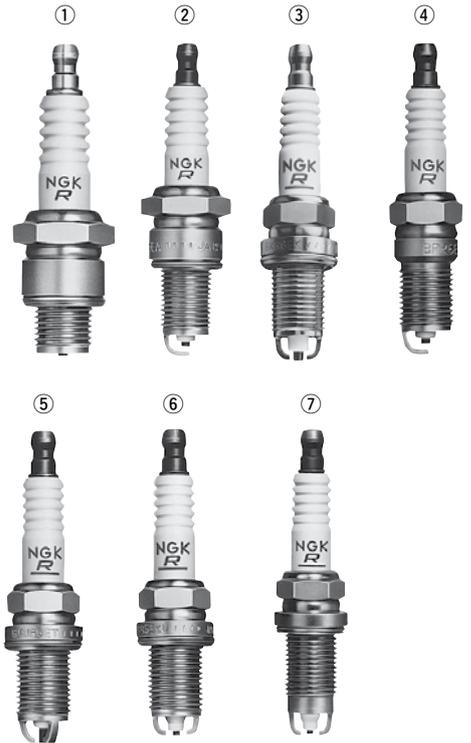



SERIES OF NGK SPARK PLUGS



PROJECTED GAP TYPE

	NON-RESISTOR	RESISTOR
14mm ϕ \times 19.0mm 20.8 Hex Fig. ①(a)	BE527Y-11 BE529Y-11	BRE527Y-11 BRE529Y,-11
Fig. ②(b)		ZGR4A ZGR5A
14mm ϕ \times 26.0mm 20.8 Hex Fig. ②(d)	ZG5D-11	
14mm ϕ \times 20.5mm 20.8 Hex Fig. ②(b)		ZGR5B,-11 ZGR6B-11
14mm ϕ \times 22.0mm 20.8 Hex Fig. ②(c)		ZGR5C
14mm ϕ \times 19.0mm 16.0 Hex Fig. ③(b)	ZF6A-11	ZFR5A-11 ZFR6A-11
Fig. ④(b) ISO		ZFR4F-11 ZFR5F,-11 ZFR6F-11,G ZFR7F,-11
Fig. ④(b) ISO		ZFR5J-11 ZFR6J-11 ZFR7J-11
Fig. ③(a)		BCRE527Y
14mm ϕ \times 20.5mm 16.0 Hex		ZFR6K-11S
Fig. ③(e)		ZFR5G ZFR6G
14mm ϕ \times 22.5mm 16.0 Hex Fig. ③(c)		ZFR4E-11 ZFR5E-11 ZFR6E-11
Fig. ③(d)		ZFR5D-11 ZFR6D-11
14mm ϕ \times 25.0mm Conical seat 16.0 Hex Fig. ⑤(b)		LZTR4A-11 LZTR5A-13

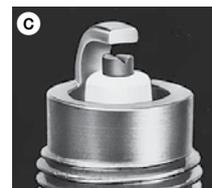
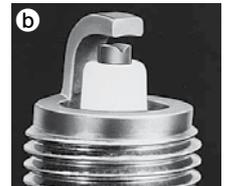
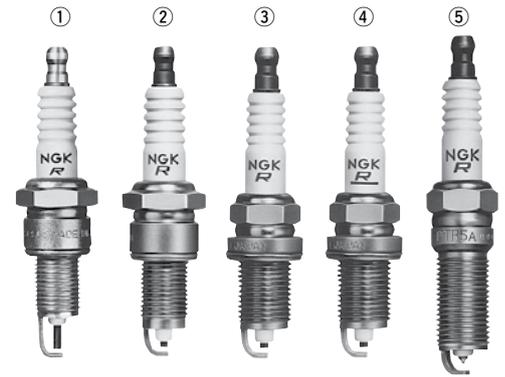

COMPETITION TYPES

14mm ϕ \times 12.7mm 20.8 Hex Fig. ⑥(f)	B7HCS B8HCS B9HCS	BR8HCS-10
14mm ϕ \times 19.0mm 20.8 Hex Fig. ⑦(f)	B7ECS B8ECS B9ECS	BR8ECS BR9ECS BR10ECS
Fig. ⑧(f)		BR8ECM BR9ECM BR10ECM



SERIES OF NGK SPARK PLUGS



I PLATINUM, IRIIDIUM TIPPED TYPES

	NON-RESISTOR	
14mm ϕ × 19.0mm 20.8 Hex Fig. ① i	PGR5A,-11 PGR5C-11 BPR5EP-11,-13 PGR6A,-11 PGR6C-11 BPR6EP-8 PGR7A,-11 IGR7A	
14mm ϕ × 19.0mm 20.8 Hex Fig. ① h	IGR5C13	
14mm ϕ × 19.0mm 16.0 Hex Fig. ② a	PFR5A-11 PFR5K-11 BCPR5EP-8,-11,-13 PFR6A-11 PFR6H-10 PFR6K-11 BCPR6EP-8,N-8,-11,-N-11,-13 PFR7A-11 PFR7H-10	
Fig. ③ h ISO	FR4AP-10,-11 FR4BP-11 FR5AP-10,-11 FR5BP-11 FR5AP-11E FR6AP-10,-11 FR6BP-11 FR7AP-11	
	FR5EI-13	
	PFR4B-11 PFR4C-11 PFR5B,-9,-11,-11B PFR5C-11 PFR6B,-9,-11,-11B,-11C PFR6C-11 PFR6E-10 PFR7B,-9,-11,-11C PFR8B,-9	
	PFR4G-11 PFR5J-11 PFR5G-11,-13E PFR6H-10 PFR6J,-11 PFR6G,-9,-11,-13,-13E PFR7G,-9,-11	
	PFR5L-11 PFR5N-11 PFR4P PFR6L-11,-13 PFR6N-11 PFR5P,-11 PFR7N-D PFR6P,-11 PFR6Q PFR7Q	
	PFR5R-11	
	BKR5EP-8,-11 BKR6EP-8,-11,-13,-N-8	
	Fig. ④ c ISO	BKR6EKPA
	Fig. ④ d ISO	BKR5EKUP
	Fig. ④ e ISO	BKR5EKP-11,-13 BKR6EKP-11
Fig. ④ j ISO	BKR5EQUPA BKR6EQUP BKR6EQUPA	
Fig. ③ f ISO	PFR6M PFR7M	
Fig. ③ g ISO	PZFR5B PZFR5F,-11,-13 PZFR6B PZFR6F,-11 PZFR7F	
Fig. ③ h ISO	IFR5A11,-8N IFR5D10 IFR5E11 IFR6A11 IFR6C IFR6D10 IFR6E11 IFR7F-D	
	IFR5G11 IFR5J11 IFR5N10 IFR5T-8N,11 IFR6J11 IFR6S IFR6T11	
Fig. ② g	IZFR5B IZFR5F11 IZFR6B IZFR6F11	
	ZFR5LP-13G	
14mm ϕ × 22.0mm 16.0 Hex Fig. ⑩ k ISO	PZFR5C PZFR5D-11	
Fig. ⑩ k ISO	IZFR5C IZFR7E-D	
14mm ϕ × 25.0mm conical seat 16.0 Hex Fig. ⑥ h	PTR5A-13	





SERIES OF NGK SPARK PLUGS



	NON-RESISTOR
14mm ϕ × 17.5mm conical seat 16.0 Hex Fig. ⑨①	PTR4B-15 PTR5C-13,-15 ITR4A15 ITR5F13 ITR6F13
14mm ϕ × 17.5mm conical seat 16.0 Hex Fig. ③⑧	PTR5D-10,-13 PTR6D-13,-13G
Fig. ⑨⑨	PZTR5A-15
14mm ϕ × 20.5mm 16.0 Hex Fig. ③②	IZFR6K11,11E,13 IZFR6K-11S,IZFR6K11NS
14mm ϕ × 21.5mm 16.0 Hex Fig. ①③	PZFR5N-11T
14mm ϕ × 22.0mm 16.0 Hex Fig.	PZFR6J-11
14mm ϕ × 26.5mm 16.0 Hex Fig. ①①②	PLFR4A-11 PLFR5A-9,-11 PLFR6A-9,-11 PLFR7A-9
Fig. ①①⑨	ILZFR6A11
14mm ϕ × 29.5mm 16.0 Hex Fig. ①①①	LZFR5AQP
14mm ϕ × 25.0mm conical seat 16.0 Hex	PLZTR4A-13,PLZTR5A-13
12mm ϕ × 19.0mm 18.0 Hex Fig. ⑤⑧	PJR6A PJR7A PJR8A
	IJR7A9
12mm ϕ × 19.0mm 16.0 Hex Fig. ⑦①	PKR7A PKR9B
12mm ϕ × 19.0mm 16.0 Hex Fig. ⑦③	DCPR8EKP
12mm ϕ × 22.0mm 16.0 Hex Fig.	IZKR7A
12mm ϕ × 28.0mm 16.0 Hex	ILZKR7B11 ILZKR7B-11S ILZKR7B11GS
10mm ϕ × 19.0mm 16.0 Hex Fig. ⑧①	PMR7A PMR8A PMR8B
10mm ϕ × 19.0mm 16.0 Hex Fig. ⑫	IMR9C-9H IMR9C-9HE,IMR9C-9HES
12mm ϕ × 26.5mm Bi-Hex 14.0mm	ILZKBR7A-8G PLZKBR7A-G

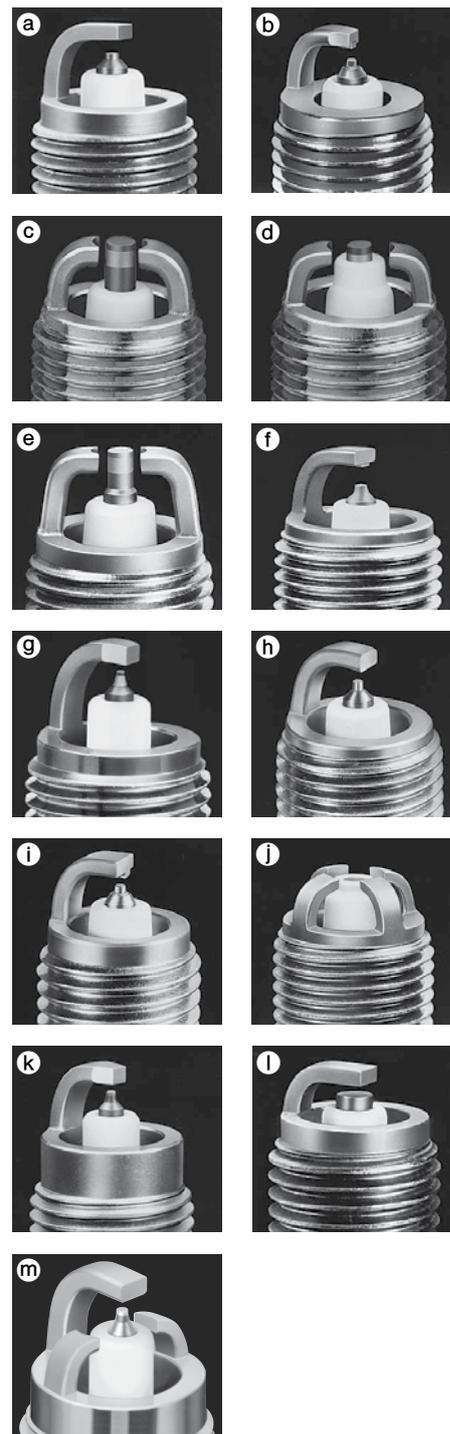



SERIES OF NGK SPARK PLUGS



COMPACT TYPES

	NON-RESISTOR	RESISTOR
14mm ϕ \times 9.5mm 19.0 Hex Fig. ①(a)	BM4A BM6A BM7A	B2-LM* B4-LM* BR2-LM* BR4-LM* BMR2A,-10 BMR4A BMR6A BMR7A
Fig. ①(b)	BPM4A,-10 BPM6A,-10 BPM7A	BPMR4A,-10 BPMR6A,-10 BPMR7A,-9
14mm ϕ \times 12.7mm 20.8 Hex Fig. ②(a)	BL-6H	
14mm ϕ \times 7.8mm Conical seat 16.0 Hex Fig. ③(a)	BM6F BM7F	BMR6F
Fig. ③(b)	BPM6F BPM7F	BPMR6F
10mm ϕ \times 8.6mm 14.0 Hex Fig. ④(a)	CM-6	
10mm ϕ \times 9.5mm 16.0 Hex Fig. ⑧(a)		CMR6A CMR7A
10mm ϕ \times 12.7mm 16.0 Hex Fig. ⑧(e)		CMR5H CMR6H CMR7H
14mm ϕ \times 9.5mm 19.0 Hex Fig. ①(c)	BPM6Y BPM7Y BPM8Y	BPMR6Y BPMR8Y



FARM EQUIPMENT TYPES

PF1/2" \times 22.5mm 23.8 Hex Fig. ⑤(d)	G-27 G-2Z
---	----------------------------

SURFACE DISCHARGE TYPES

14mm ϕ \times 12.7mm 20.8 Hex Fig. ⑥(f)	BUHX(Series gap) BUHXW-1(Series gap)	
	BUH	
	BUHW BUHW-2	BUZHW BUZHW-2
14mm ϕ \times 19.0mm 20.8 Hex Fig. ⑦(f)	BUE	

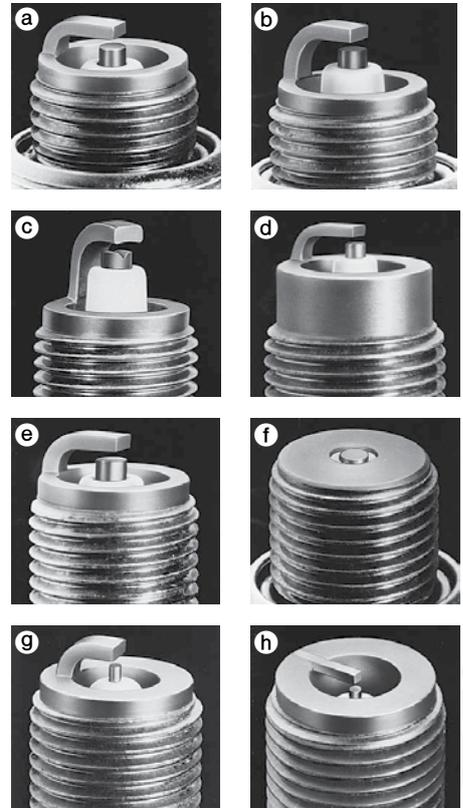

RACING TYPES

	NICKEL ELECTRODE	PRE-CIOUS METAL	PLATINUM ELECTRODE
14mm ϕ \times 19.0mm 20.8 Hex	B8EG Fig. ⑨(g) BR8EG* B9EG BR9EG* B10EG BR10EG* B11EG	B8EGV Fig. ⑨(g) B85EGV B9EGV B95EGV B10EGV B105EGV B11EGV	B8EGP Fig. ⑨(h) B85EGP B9EGP B95EGP B10EGP

*Resistor Type



SERIES OF NGK SPARK PLUGS



IX TYPES	
18mm ϕ × 10.9mm 20.8 Hex Fig. ① a	WR5IX
14mm ϕ × 19.0mm 20.8 Hex Fig. ② b	BPR5EIX, -11 BPR6EIX, -11 BPR7EIX BPR8EIX BPR9EIX
Fig. ② c	BR7EIX BR8EIX BR9EIX BR10EIX
Fig. ② d	BR8ECSIX BR9ECSIX, -5
Fig. ③ d	BR8ECMIX BR9ECMIX BR10ECMIX
14mm ϕ × 12.7mm 20.8 Hex Fig. ④ b	BPR6HIX BPR7HIX BPR8HIX
Fig. ④ c	BR6HIX BR7HIX BR8HIX BR9HIX BR10HIX
14mm ϕ × 9.5mm 20.8 Hex Fig. ⑤ a	XR4IX XR5IX XR45IX
14mm ϕ × 19.0mm 16.0 Hex Fig. ⑥ b	BCPR7EDIX
Fig. ⑦ b	BCPR5EIX, -11 BCPR6EIX, -11 BCPR7EIX, -11
Fig. ⑧ b	BKR4EIX BKR5EIX, -11 BKR6EIX, -11 BKR7EIX, -11 BKR8EIX BKR9EIX
Fig. ⑧ e	ZFR5FIX-11 ZFR6FIX-11
14mm ϕ × 26.5mm 16.0 Hex Fig. ⑨ b	LFR5AIX-11 LFR6AIX-11 LFR7AIX
14mm ϕ × 17.5mm Conical seat 16.0 Hex Fig. ⑩ b	BPR6EFIX-10, -15
Fig. ⑩ a	TR4IX TR5IX TR6IX TR7IX TR8IX
	TR55IX TR65IX TR75IX TR85IX
14mm ϕ × 20.5mm Conical seat 16.0 Hex Fig. ⑪ e	TR5-1IX TR45-1IX TR55-1IX
14mm ϕ × 11.2mm Conical seat 16.0 Hex Fig. ⑫ c	YR5IX YR55IX
Fig. ⑫ c	BR6FIX
Fig. ⑫ a	UR4IX UR5IX UR6IX
	UR45IX UR55IX
14mm ϕ × 25.0mm Conical seat 16.0 Hex Fig. ⑬ b	LTR5IX-11 LTR6IX-11 LTR7IX-11
Fig. ⑬ e	LZTR4AIX-11 LZTR5AIX-13 LZTR6AIX-13 LZTR7AIX-13

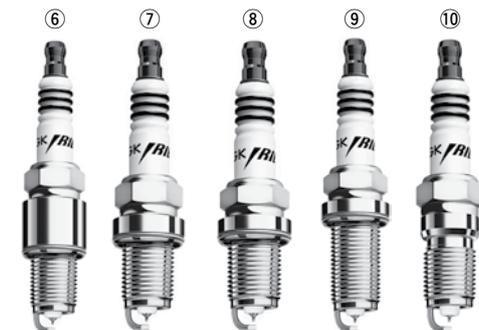



SERIES OF NGK SPARK PLUGS



IX TYPES

		NON-RESISTOR
12mm ϕ \times 19.0mm 16.0 Hex Fig. ①a		DCPR6EIX DCPR7EIX DCPR8EIX DCPR9EIX
	Fig. ①b	DCR7EIX DCR8EIX DCR9EIX
12mm ϕ \times 19.0mm 18.0 Hex Fig. ②a		DPR7EIX-9 DPR8EIX-9 DPR9EIX-9
	Fig. ②b	DR7EIX DR8EIX DR9EIX
12mm ϕ \times 21.0mm 18.0 Hex Fig. ③a		DPR8ZIX
12mm ϕ \times 26.5mm Conical seat 14.0 Hex Fig. ④d		ZNAR7AIX ZNAR6AIX-11
10mm ϕ \times 19.0mm 16.0 Hex Fig. ⑤a		CPR7EAIX-9
	Fig. ⑤c	CR7EIX CR8EIX CR9EIX CR10EIX
	Fig. ⑥b	CR8EHIX-9 CR9EHIX-9
10mm ϕ \times 12.7mm 16.0 Hex Fig. ⑦b		CR5HIX CR6HIX CR7HIX CR8HIX CR9HIX
8mm ϕ \times 19.0mm 13.0 Hex Fig. ⑧e		ER8EHIX ER9EHIX

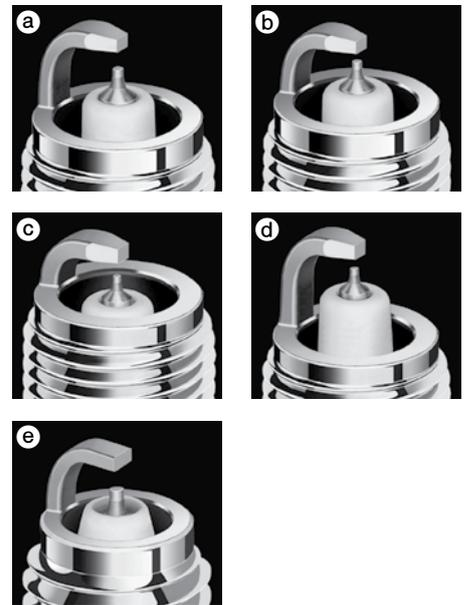
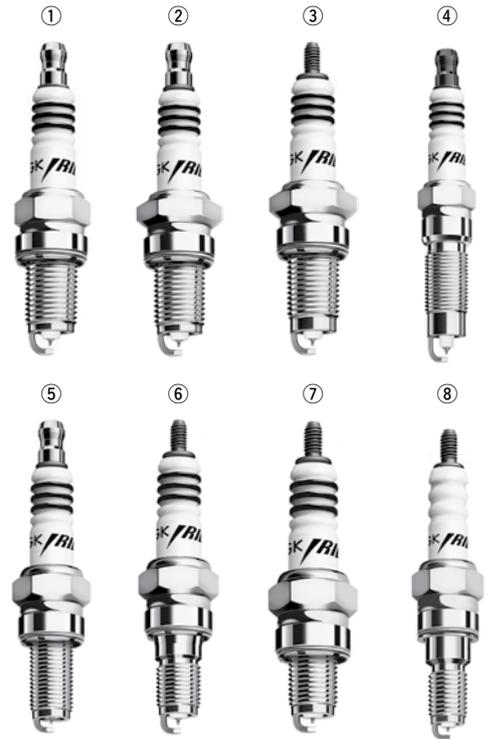

STRUCTURE OF A SPARK PLUG

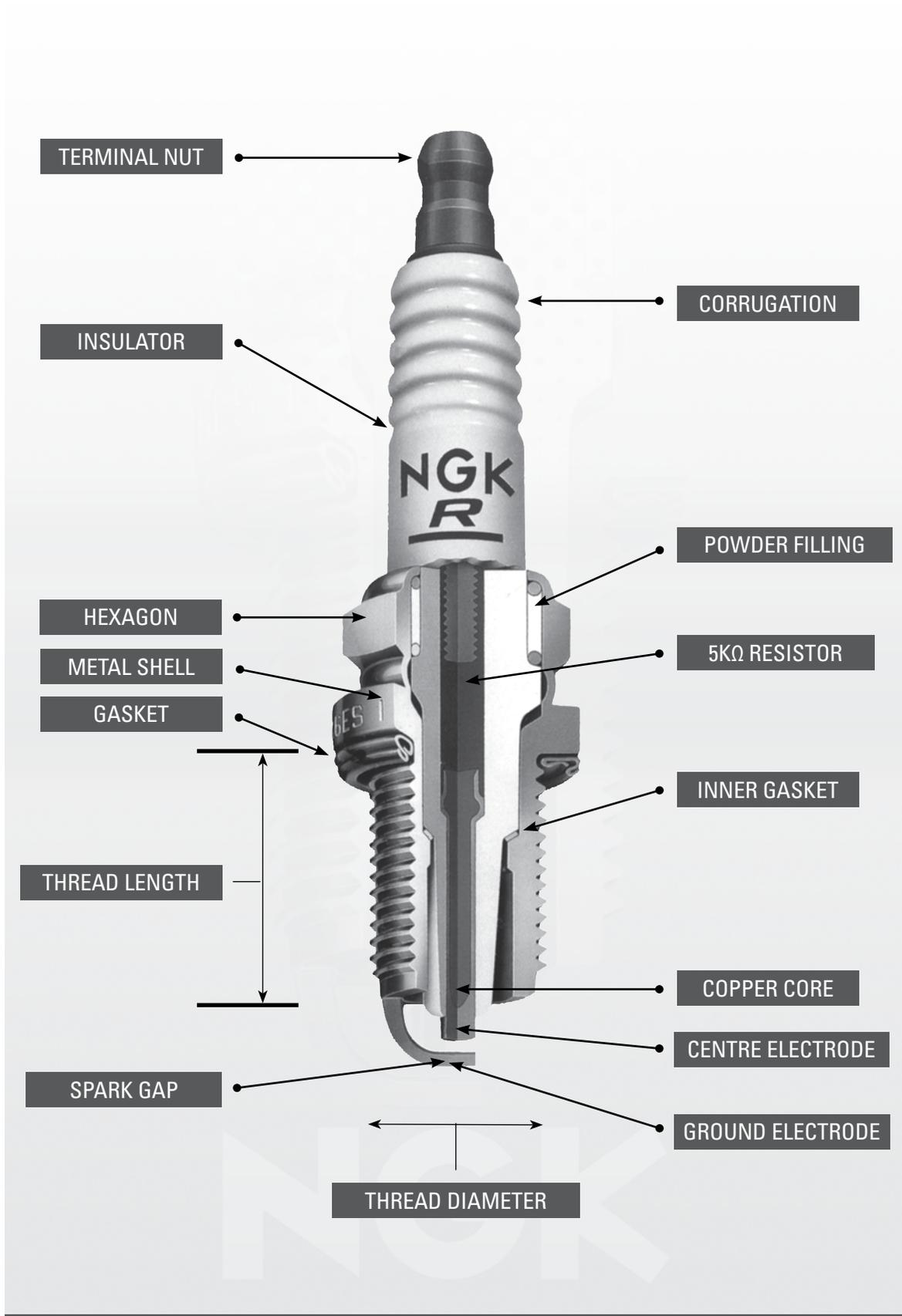



NGK SPARK PLUG INFORMATION CHART



DESIGN SYMBOLS

A 18mm AB 18mm B 14mm BC 14mm BK 14mm C 10mm D 12mm DC 12mm E 8mm G PF1/2 J 12mm	Thread Size Hexagon Size	25.4mm 20.8mm 20.8mm 16.0mm 16.0mm 16.0mm 18.0mm 16.0mm 13.0mm 23.8mm 18.0mm	L Compact type (Short) M Compact type (Bantam) P Projected insulator type R Resistor type U Surface or semisurface discharge type Z Inductive resistor type	Construction Features	2 Hotter ↑ 4 5 6 7 8 8.5 9 9.5 10 10.5 11 12 13 Colder ↓	E 19.0mm EF 17.5 EH Part threaded Total 19.0mm Thread 12.7mm F Taper seat type A-F Type 10.9mm B-F Type 11.2mm B-EF Type 17.5mm B-M-F Type 7.8mm B-S Type 9.5mm H 12.7mm L 11.2mm Z 21mm NO SYMBOL 18.0mm = 12mm reach 14.0mm = 9.5mm reach Tapered seat type: A(P)-F: 10.9 B(P)-F: 11.2 BM(P)-F: 7.8 Small type plug: B(P)M: 9.5 B-LM: 9.5 CM: 9.5 CM-6 :8.6 C-50:8.5	Thread Reach	Spark Gap Spark gap (mm) "No number = standard/preset" NO SYMBOL Motorcycle: 0.7-0.8 Car: 0.8-0.9 -8 0.8 -9 0.9 -10 1.0 -11 1.1 -13 1.3 -15 1.5 -S Special gasket -E Special resistance IX-P Iridium MAX plug IX-LPG Iridium IX plug for LPG RX-P Premium RX plug
---	---	--	--	------------------------------	---	---	---------------------	--

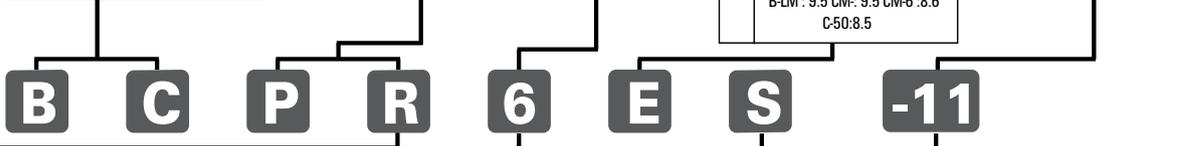

Firing End Construction, etc.		
A Special design	GV Racing spark plug	P Platinum electrodes
B Integral terminal (CR8EB)	I Single Iridium spark plug	Q 4-ground-electrodes
C Low angle ground electrode	IX Iridium IX spark plug	R Special ground electrode
CM Slant ground electrode length: 18.5	J 2-projecting-ground electrodes	S Standard type
CS Slant ground electrode	K 2-ground-electrodes	T 3-ground-electrodes
D Special design	KC 2-ground-electrodes	U Semi-surface discharge gap
E V-grooved centre electrode (14mm only) 1/5mm insulator	KUB 2-ground-electrodes semisurface discharge	V Gold-palladium electrode
ES Standard 19mm thread reach (2.5mm) centre electrode Tapered seat	L Half heat range	VX Platinum centre electrode & special ground electrode
F Tapered seat	LM Compact type (Insulator length: 14.5)	W Tungsten electrode
G Fine nickel alloy centre electrode	M 2-ground-electrodes for Mazda rotary engines or insulator length: 18.5mm	X Booster gap
GP Platinum-Finewire (6mm)	N Special ground electrode	Y V-grooved center electrode
		Z Special design



Plug Type	Metal Shell Size	Construction	Construction	Spark gap (mm)	Feature
D High ignitability plug Double fine electrodes	F 14ø x 19mm, 16.0mm Hex.	R Resistor	A.B.C -Suffix code	Motorcycle: 0.7-0.8 Car: 0.8-0.9"	A Non gasket
DI High ignitability plug: Double fine electrodes	FE 14ø, 19mm, 16.0mm Hex.		I Single Iridium	7 0.7 mm	B Special
I Iridium electrode	G 14ø x 19mm, 20.8mm Hex.		IX Iridium IX spark plug	8 0.8 mm	C Special
IZ Iridium electrode & extended gap	GR 14ø, 19mm, 20.8mm Hex.		P Single Platinum spark plug	9 0.9 mm	D Metal shell: nickel plating
L Thread Reach 26.5mm	J 12ø x 19mm, 18.0mm Hex.		When there is "I" or "P" at the beginning of after heat rating becomes suffix code.)	10 1.0 mm	E Special resistance
P Platinum electrode	K 12ø x 19mm, 16.0mm Hex.		<Example> IZFR6P8 is Iridium spark plug I: Iridium P: Suffix code	11 1.1 mm	G Copper cored ground electrode
PL Platinum electrode & thread reach 26.5mm	KA 12ø x 19mm, 14.0mm Hex.		<Exception> ZFR6P-G is nickel spark plug	12 1.2 mm	H Special thread shape
PZ Platinum electrode & extended gap	KB 12ø x 19mm, 14.0mm Bi-Hex.			13 1.3 mm	J-K 2 ground-electrode Vibration-resistance ground electrode
S High ignitability plug Thin square tip type	KE 12ø, 19mm, 16.0mm Hex.			14 1.4 mm	N Special ground electrode
Z Extended Gap	KF 12ø, 19mm, 14.0mm Hex.			15 1.5 mm	Q 4-ground-electrode
	KG 12ø, 19mm, 14.0mm Bi-hex.			20 2.0 mm	S Special gasket
	L 10ø x 12.7mm, 16.0mm Hex.				T 3-ground-electrode
	M 10ø x 19mm, 16.0mm Hex.				U Semi-surface discharge type
	MA 10ø x 19mm, 14.0mm Hex.				IX-P Iridium MAX plug
	NA 12ø, 17.5mm, 14.0mm Hex.				IX-LPG Iridium IX plug for LPG car
	T Tapered seat type				RX-P Premium RX plug
	U 14ø x 17.5mm, 16.0mm Hex.				
	W 18ø x 10.9mm, 20.8mm Hex.				
	X 14ø x 9.5mm, 20.8mm Hex.				
	Y 14ø x 11.2mm, 16.0mm Hex.x				

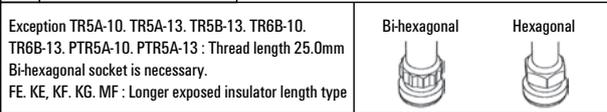



DESIGN SYMBOLS

RE		7		C		-L		
Plug Type		Heat Rating		A.B.C - Suffix code		-L		
RE	Plug for rotary engines	5	Hotter			-L	Leading side	
SD	Plug for rotary engines (Semi-surface discharge gap)	6	↑ ↓			-T	Trading side	
		7						
		8						
		9						
		10						
		11	Colder					

HB		6		A		IX		-11		P		
Plug Type		Heat Rating		Thread diameter		IX		Spark gap (mm)				
HB	HYBD (3-ground-electrode hybrid type)	4	Hotter	A	14φ x 20.5mm, Gasket, 16.0mm Hex.			-8	0.8 mm			
		5	↑ ↓	B	14φ x 19mm, Gasket, 16.0mm Hex.			-9	0.9 mm			
		6							-10	1.0 mm		
		7							-11	1.1 mm		
		8		Colder					-13	1.3 mm		

DF		6		H		-11		P				
Plug Type		Heat Rating		Thread diameter		Spark gap (mm)		A.B.C - Suffix code				
DF	High ignitability plug (Double fine electrodes)	4	Hotter	A	14φ x 19mm, Gasket, 16.0mm Hex.	-8	0.8 mm					
DFH	High ignitability plug (DF + Hybrid type)	5	↑ ↓	B	14φ x 26.5mm, Gasket, 16.0mm Hex.	-9	0.9 mm					
		6					-10					1.0 mm
		7					-11					1.1 mm
		8					-13					1.3 mm
		9		Colder			-15					1.5 mm

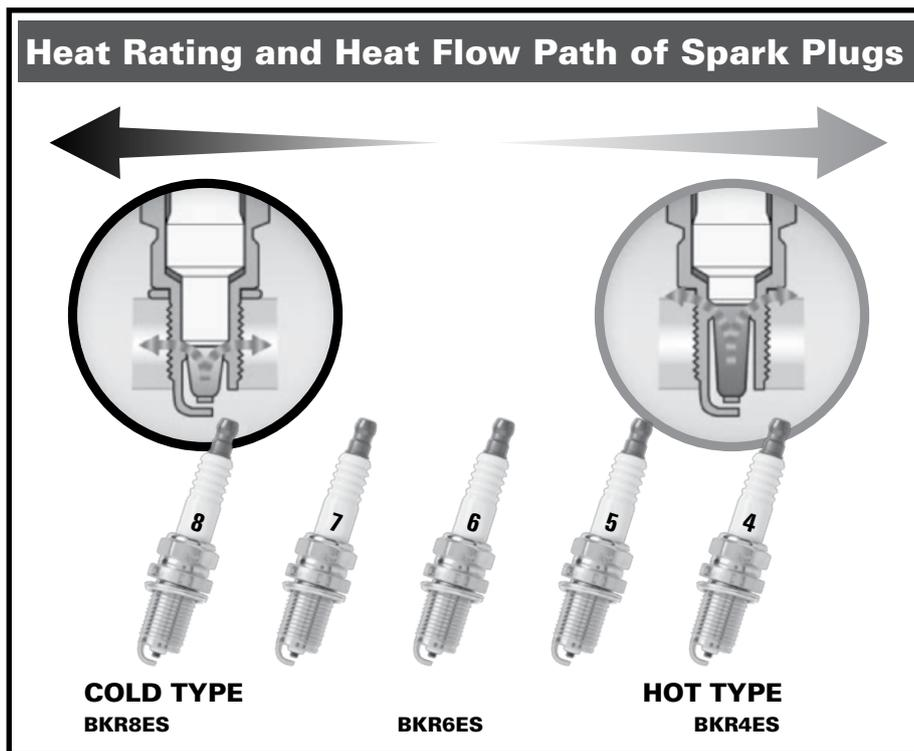



SPARK PLUG CHARACTERISTICS

VARIOUS SPARK PLUGS AND THEIR CHARACTERISTICS



Double precious metal plug (long life type)

Standard plug

(Example) **BKR5ES-11**



V-grooved center electrode spark plug

(Example) **BKR5E-11**

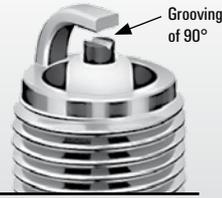

- Grooving is done at 90° for the center electrode and thus sparks are easily discharged.
- Since the sparks are discharged at near the periphery of the center electrode, there is less quenching action of the electrode, and ignition performance is enhanced. Therefore, it is effective during engine start-up, idling and acceleration.

Platinum plug

(Example) **PFR5G-11**

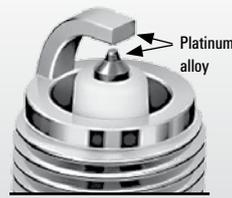

- Platinum alloy or Iridium alloy are used in the center electrode. Moreover, platinum alloy is used in discharge part of the ground electrode. This is the high performance and long life plug.

Iridium plug

(Example) **ILTR6A-13G**

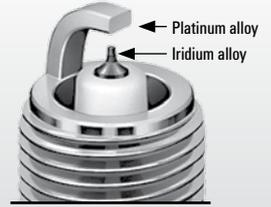

High ignitability plug

High ignitability nickel plug

(Example) **LR7D**



- The diameter of the center electrode tip is made thinner and the ground electrode is made oval shaped. Thus the flame quenching effect is reduced and ignitability is improved.

PSPE® Plug

(Example) **BKR5ERX-11P**



- Compared to the conventional plugs, the ground electrode is shortened to reduce its overlap onto the center electrode, thereby reducing the flame quenching effect and further enhancing the ignitability. It provides for excellent breakage countermeasures by suppressing overheating of the ground electrode. This is the high performance and long life plug which gives stable combustion even in high compression engines.

SPE® Plug

(Example) **SILFR6A**

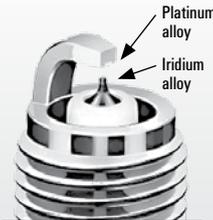

- With a small diameter center electrode and the taper-cut design of the ground electrode, the sparks are concentrated on the tip and the flame quenching effect is suppressed. To further ensure durability, thin square platinum alloy is welded to the ground electrode.

DFE plug (Double fine electrode)

(Example) **DILKAR7B11**

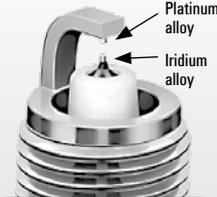

- Iridium alloy is used at the tip of the center electrode and fine wire platinum alloy is welded on the ground electrode. This design achieves a high performance and long life.

3-ground electrode hybrid type

HYBD (Hybrid 3 ground electrode plug)

(Example) **PZFR5N-11T**



- Normally sparks discharge between main electrodes. When there is carbon fouling, sparks discharge between the side electrode and the center electrode, burning out the carbon deposits on the insulator.

Multi-ground electrode plug

2-ground-electrode plug

(Example) **BKR6EK**



3-ground-electrode plug

(Example) **BKUR6ET**



4-ground-electrode plug

(Example) **BKR6EQUP**



- Background of making the ground electrode multi-polarized is to ensure durability by distributing the electrode consumption. Multi-electrode plug is effective in improving the discharge characteristics (required voltage reduces).
- BKR6EQUP is a semi-surface discharge type plug. Sparks discharge along the insulator surface and burns away the carbon accumulated on the insulator. This plug has robust anti-carbon fouling performance.

Firing end-projection type plug

(Example) **IZFR6K11** [Extended metal shell]



- Stable combustion can be achieved by moving the ignition position to center of the combustion chamber. However, if the projection type plug is used in engines other than those that have been specified, it will hit the piston or valve. Hence, it can only be used for specified vehicles.
- As for extended metal shell type, the ground electrode is designed shorter than the normal plug to reduce load due to heat and vibration.



SPARK PLUG CHARACTERISTICS

ANTI-FOULING CHARACTERISTICS



CARBON FOULING

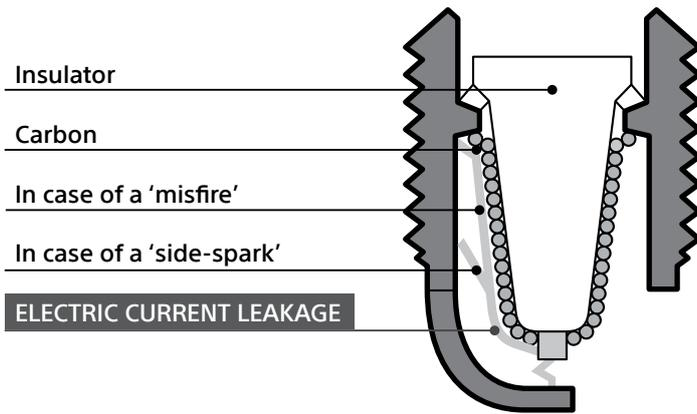

- The firing end of the plug is exposed in the combustion chamber. Hence, carbon particles etc. adhere to the firing end.
- Since the carbon particles covering the firing end insulator are conductive, electric current leaks out. Therefore the high voltage that is required for electrical discharge cannot be reached between electrodes. This leads to 'side spark' which is spark discharge between the tip of the metal shell and the insulator, or 'misfire' when there is no spark discharge.

- Following firing shows the impact on insulation resistance when the insulator gets wet by liquid fuel.
- The carbon which adheres to the firing end of the plug includes dry carbon (atomized fuel) and wet carbon (liquid fuel). In case of the adherence of the dry carbon, since there is a clearance between the carbon particles, electric current does not flow between the carbon particles, and hence the decrease in the insulation resistance is less.
- However, in case of the adherence of the liquid fuel, since the carbon particles are in close contact, electric current flows through them as a result of which insulation resistance decreases.
- In short, the adherence of liquid fuel promotes the movement of the carbon particles and their close contact with each other, thus resulting in the lowering of the insulation resistance.

	DRY CARBON (ATOMIZED FUEL)	WET CARBON (LIQUID FUEL)
Concept model diagram		
Insulation resistance	<p>100MΩ</p>	<p>0MΩ</p>

Wet carbon adhesion mechanism

- As mentioned above, since the plug firing end is exposed in the combustion chamber, it is always exposed to either the incoming air-fuel mixture or the fuel gas. If there is normal combustion, the firing end insulator of the plug gets heated due to the combustion gas and thereby, it is possible to keep the surface of the insulator in a dry state.
- However, if the air-fuel mixture is remarkably rich or remarkably lean, then in case of lack of ignition when the air-fuel mixture does not burn, some of the unburned air-fuel mixture sticks to the surface of the insulator and it results in a wet state as shown in the figure above.

NGK SPARK PLUGS DIAGNOSTIC CHART



Normal



Using Unleaded Petrol

(Life in case of normal use)

A worn spark plug not only wastes fuel but also strains the whole ignition system because the expanded gap requires higher voltage.

It also reduces the engine's efficiency, resulting in reduced fuel economy and increased exhaust emissions. Moreover, it contributes to pollution generated by exhaust gas.

SYMPTOMS

CAUSES

REMEDY

<ul style="list-style-type: none"> • Hard starting • Misfiring • Black exhaust smoke 	CARBON FOULING		<ul style="list-style-type: none"> • Rich mixture • Retarded ignition • Low compression • Too cold a spark plug 	<ul style="list-style-type: none"> • Check float level • Check choke • Check ignition timing • Check air cleaner • Check compression • Replace spark plug with correct heat range
<ul style="list-style-type: none"> • Hard starting • Misfiring • Grey / white exhaust smoke • Loss of oil 	OIL FOULED		<ul style="list-style-type: none"> • Worn rings • Worn piston • Leaking valve stem seals • Over-filled oil sump 	<ul style="list-style-type: none"> • Replace worn components • Replace spark plug with correct heat range
<ul style="list-style-type: none"> • Misfiring • Hard starting • No starting 	DEPOSIT		<ul style="list-style-type: none"> • Fuel quality • Oil leakage • Engine operating period 	<ul style="list-style-type: none"> • Replace spark plug • Change fuel brand • Repair engine (if need be)
<ul style="list-style-type: none"> • Misfiring • Engine noise 	BREAKAGE OF THE INSULATOR		<ul style="list-style-type: none"> • Sudden change in temperature (Thermal shock) • Oil leakage • Internal engine stress 	<ul style="list-style-type: none"> • Replace spark plug • Check engine condition • Repair engine (if need be)
<ul style="list-style-type: none"> • "Pinking" under acceleration or climbing hills • Engine run-on after switching off 	OVERHEATING		<ul style="list-style-type: none"> • Lean mixture • Advanced ignition timing • Too hot a spark plug 	<ul style="list-style-type: none"> • Check jets are not clogged • Check float level • Check ignition timing • Replace spark plug with correct heat range
<ul style="list-style-type: none"> • Misfiring • Loss of power • Hard starting • Noise in engine 	DAMAGED		<ul style="list-style-type: none"> • Foreign particles inside cylinder • Broken or damaged valve 	<ul style="list-style-type: none"> • Replace spark plugs • Remove foreign or damaged components
<ul style="list-style-type: none"> • Hard starting • Misfiring • Black exhaust smoke 	UNDER TIGHTENING		<ul style="list-style-type: none"> • Spark plug incorrectly torqued • Spark plug only handtightened • Dirt or carbon in threads of cylinder head 	<ul style="list-style-type: none"> • Replace spark plugs • Tighten spark plug to correct torque • Replace damaged components • Check compression on all cylinders
<ul style="list-style-type: none"> • Hard starting • Reduced fuel economy 	WORN		<ul style="list-style-type: none"> • Normal electrode wear • $\pm 0.03\text{mm} / 1\ 000\text{km}$ • Fuel deposits (carbon, lead, additives & salts) 	<ul style="list-style-type: none"> • Replace spark plug with correct heat range
<ul style="list-style-type: none"> • Hard starting • Misfiring 	MELTING		<ul style="list-style-type: none"> • Lean mixture • Advanced ignition timing • Too hot heat range 	<ul style="list-style-type: none"> • Replace with correct heat range spark plug • Check air / fuel mixture
<ul style="list-style-type: none"> • Misfiring • Loss of power • Noise in engine 	BREAKAGE OF THE GROUND ELECTRODE		<ul style="list-style-type: none"> • Under tightening 	<ul style="list-style-type: none"> • Correct tightening torques
<ul style="list-style-type: none"> • Misfiring • Hard starting • Reduced fuel economy 	FOULING BY FUEL ADDITIVE		<ul style="list-style-type: none"> • Excess MMT and Ferrocene • Incorrect heat range 	<ul style="list-style-type: none"> • Replace spark plugs with correct heat range • Get to 450°C self cleaning temperature



NGK CATALOGUE 2021

NGK SPARK PLUGS SA (PTY) LTD (CO REG. NO. 2006/014122/07)

HEAD OFFICE: Bantry Park • 41 Jansen Road • Jet Park • Boksburg • 1459 • South Africa

PO Box 8156 • Elandsfontein • 1406

T (011) 418-7900 • F (011) 418-7920 • Email orders: orders@ngkntk.co.za