



GIVI[®]

EXPLORE. ENJOY.

**HARD & SOFT
BAGS
CATALOG**

HARD BAGS



ST
E
K
E
P
Q
U
E

MONOKEY® SYSTEM



Monokey®, patented by GIVI, is the most widespread fitting system for hard cases and side cases. Simple to use, it allows operation with only one key both the opening of the case top and the detachment of the case from the fitting plate. All the Monokey® products combine the best characteristics of mechanical resistance and rigidity of the fitting, with features using compact and light components. The even distribution of the load on the plate surface is guaranteed by the three fitting points. The damping of oscillating and vibration and the contact between the bottom shell and the plate are assured by four spacers made of elastic material, which is particularly resistant to extreme weather and temperature variation. Thanks to these solutions a high level of reliability of the fitting is guaranteed.

MONOLOCK® SYSTEM



In order to offer a wider range of applications and uses, GIVI has introduced Monolock®. Following the same philosophy that defines the Monokey® fitting system; this second solution is mostly made for lighter vehicles, such as scooters and maxi-scooters. Even with limitations of maximum load, this system of fitting combines performances comparable to those of the Monokey® system with components boasting lighter and far smaller dimensional restrictions. Because of its natural compatibility with different kinds of motorcycles, it is appreciated by the most important brands of motorcycle producers, who have adopted it for their original accessories. As well as for Monokey®, the opening of the case top shell and the detachment of the case from the plate are operated with one key only.

MONOKEY® CAM-SIDE SYSTEM



The Trekker Outback are cases studied especially for the off-road use. For supporting all the demands that are subject in off road, they need fitting systems and side-case holders stronger than the Monokey®. For this reason it has been studied that the new Monokey® Cam-Side system, fixes the case in four different points maintaining at the same time the possibility to release from the rack quickly. The specific side-case holders are the PL_ _ _CAM and PLR_ _ _CAM that are manufactured using steel tubular with an 18 mm diameter, and are fixed to the bike in different points, in order to strengthen the structure. Besides the panel of the frame where the case is linked, it is better if the rubber supports points are moved in the perimetric zones of the case.

MONOKEY® SIDE SYSTEM

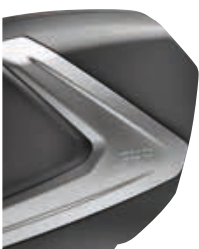

Introduced on the market in 2006, the Monokey® Side attaches onto the side of the above-mentioned two fitting systems, and thereby introducing different fitting solutions for the motorcyclist. Patented by GIVI, Monokey® Side represents an interesting evolution of the classic system constituted by the "fitment Kit plus the side-bag". The new solution introduces new advanced technical features and some other points of interest: the cases that adopt Monokey® Side can be recognized by the shaped profile of the bottom and by the addition of two new fixing points, composed by "sleds". The latter receive the disengagement movement from the case release button and determine a significant and further increase in overall stability. Monokey® Side allows greater adhesion of the case to the side of the motorcycle, improving the aerodynamic aspect. The motorcyclist's habits won't change, since it will continue to open/close and attach/detach the case equipped with Monokey® Side with one key and push button.

MONOKEY® TOP CASES

TREKKER OUTBACK 58



Valigia Trekker Outback in alluminio, 58 lt
Trekker Outback 58 ltr. top case, aluminum

TREKKER OUTBACK 42



Valigia Trekker Outback in alluminio, 42 lt
Trekker Outback 42 ltr. top case, aluminum

TREKKER ALASKA 56



Valigia in alluminio Trekker Alaska, 56 lt
Trekker Alaska 56 ltr. top case, aluminum



TREKKER ALASKA 44



Valigia in alluminio Trekker Alaska, 44 lt
Trekker Alaska 44 ltr. top case, aluminum

V56 MAXIA 4



Valigia Maxia4 nera con finitura in alluminio o texture carbonio, 56 lt
Maxia4 56 ltr. top case, black with aluminum or carbon look finish

TREKKER 52



Valigia Trekker nera con finitura in alluminio, 52 lt
Trekker 52 ltr. top case, black with aluminum finishing

V47



Valigia nera con finitura in alluminio o texture carbonio, 47 lt
47 ltr. top case, black with aluminum or carbon look finish

V46



Valigia nera, 46 lt
46 ltr. top case, black

TREKKER DOLOMITI 46



Valigia Trekker Dolomiti in alluminio, 46 lt
Trekker Dolomiti 46 ltr. top case, aluminum

TREKKER II 35



Valigia Trekker II nera con finitura in alluminio, 35 lt
Trekker II 35 ltr. top case, black with aluminum finishing

E460



Valigia nera, 46 lt
46 ltr. top case, black

V40



Valigia nera, 40 lt
40 ltr. top case, black

TREKKER DOLOMITI 30



Valigia Trekker Dolomiti in alluminio, 30 lt
Trekker Dolomiti 30 ltr. top case, aluminum

MONOKEY® SIDE CASES

TREKKER ALASKA



Coppia di valigie laterali Trekker Alaska in alluminio, 36 lt.
Pair of Trekker Alaska 36 ltrs aluminum side case

TREKKER DOLOMITI 36



Coppia di valigie laterali Trekker Dolomiti in alluminio, 36 litri
con sistema di fissaggio Monokey®
Pair of Trekker Dolomiti 36 ltrs aluminum side case,
Monokey® fitting system

TREKKER DOLOMITI 30



Valigia Trekker Dolomiti in alluminio, 30 lt
Trekker Dolomiti 30 ltr. side case, aluminum

TREKKER 46 / 33



Valigia Trekker nera con finitura in alluminio e sportello di apertura superiore, 46 e 33 lt
Trekker black case with aluminum finish and top opening, 46 and 33 ltr

TREKKER II 35



Valigia Trekker II nera con finitura in alluminio, 35 lt
Trekker II 35 ltr. top case, black with aluminum finishing

E22



Coppia di valigie laterali nere, 22 lt
Pair of black panniers, 22 lts

E360



Valigia nera, 36 lt
Black case, 36 lts

MONOKEY® SIDE

Attenzione questa valigia può essere montata SOLO con i portavaligie laterali PLX___ / PLXR___.
 Attention: this case can be mounted ONLY with the side-case holder PLX___ / PLXR___.

GIVI

EXPLORE. ENJOY.

V37



Coppia di valigie laterali nere con cover verniciate color alluminio, 37 lt
 Pair of black panniers, 37 lts black with aluminum finish

V37NN



Coppia di valigie laterali nere con finitura in texture carbonio, 37 lt
 Pair of black panniers, 37 lts black with carbon look finish

V35



Coppia di valigie laterali nere, 35 lt
 Pair of black panniers, 35 lts

MONOKEY® CAM-SIDE

Attenzione questa valigia può essere montata SOLO con i portavaligie laterali PL___CAM / PLO___CAM / PLR___CAM / PLOR___CAM.
 Attention: this case can be mounted only with the side-case holder PL___CAM / PLO___CAM / PLR___CAM / PLOR___CAM.

TREKKER OUTBACK 48



Valigia laterale Trekker Outback in alluminio, 48 lt. (destra o sinistra)
 Trekker Outback aluminum side-case, 48 lt (left-side or right-side)

TREKKER OUTBACK 37



Valigia laterale Trekker Outback in alluminio, 37 lt. (destra o sinistra)
 Trekker Outback aluminum side-case, 37 lt (left-side or right-side)

FIXED SYSTEM

TREKKER OUTBACK ATV



Valigia Trekker Outback in alluminio, 110 lt. (per Quad e Pick-up)
 Trekker Outback aluminum case, 110 lt (for ATV - Pick-up)

MONOLOCK® TOP CASES

E46 RIVIERA



Bauletto nero, 46 lt
 46 ltr. top case, black

B47 BLADE



Bauletto nero, 47 lt
 47 ltr. top case, black

E470 SIMPLY III



Bauletto nero, 47 lt
 47 ltr. top case, black

E43NML+



Bauletto nero, 43 lt
 43 ltr. top case, black

B37 BLADE



Bauletto nero, 37 lt
 37 ltr. top case, black

E370



Bauletto nero, 37 lt
 37 ltr. top case, black

B360



Bauletto nero, 36 lt
 36 ltr. top case, black

B34



Bauletto nero, 34 lt
 34 ltr. top case, black

E340 VISION



Bauletto nero, 34 lt
 34 ltr. top case, black

B330



Bauletto nero, 33 lt
 33 ltr. top case, black

B32 BOLD



Bauletto nero, 32 lt
 32 ltr. top case, black

C30



Bauletto nero, 30 lt
 30 ltr. top case, black

E300N2



Bauletto nero, 30 lt
 30 ltr. top case, black

B29



Bauletto nero, 29 lt
 29 ltr. top case, black

B27



Bauletto nero, 27 lt
 27 ltr. top case, black

TREKKER OUTBACK 48 lt



OBKN48AL (left) - OBKN48AR (right)

**TREKKER OUTBACK BLACK LINE
OBKN48BL (left) - OBKN48BR (right)**



OPTIONAL TREKKER OUTBACK 48 LT / 37 LT



E143	E144	E145	E146	E198	E205 + TAN01	E199 + STF500S
Maniglia di trasporto	Rete elastica porta oggetti	Coppia di adesivi rifrangenti	Gomme adesive protettive	Luce interna di cortesia	Supporto in nylon caricato fibra di vetro, per montare la tanica TAN01	Supporto per montare la borraccia su valigie o tubolari con diametro compreso tra i 21 ed i 25mm di diametro.
<i>Padded handles</i>	<i>Elastic carrying net</i>	<i>Pair of reflective stickers</i>	<i>Protective adhesive rubbers</i>	<i>Inner light</i>	<i>Fiberglass reinforced nylon support to mount the tank</i>	<i>Removable support to mount the STF500S on the aluminium cases or on tube with a diameter between 21 and 25 mm</i>

TREKKER OUTBACK 37 lt



TREKKER OUTBACK BLACK LINE
OBKN37BL (left) -OBKN37BR (right)



OBKN37AL (left) - OBKN37AR (right)



INFO



OPTIONAL 48 LT / 37 LT



OPTIONAL 48 LT



OPTIONAL 37 LT



HARD BAGS

SOFT BAGS



UT807C	EA120	GRT714B
Borsa cargo, espandibile	Borsa cargo, waterproof	Borsa Cargo impermeabile, 20 lt
Expandable cargo-bag	Waterproof cargo-bag	Waterproof cargo-bag, 20 lt



T507
Borsa interna waterproof per valigia 48 lt
Waterproof inner bag for Trekker Outback 48 lt



E204
Rivestimento interno per fondo e coperchio per valigia 48 lt
Interior lining for the bottom and lid of Trekker Outback 48 lt



T506
Borsa interna waterproof per valigia 37 lt
Waterproof inner bag for Trekker Outback 37 lt



E203
Rivestimento interno per fondo e coperchio per valigia 37 lt
Interior lining for the bottom and lid of Trekker Outback 37 lt

TREKKER OUTBACK 58 lt

OBKN58A



TREKKER OUTBACK BLACK LINE
OBKN58B



OPTIONAL 58 LT



INFO



10 KG

MAX LOAD



58 LT

VOLUME



323

555

355

HEIGHT/LENGTH/WIDTH

SIZES



CAPACITY



SECURITY LOCK



OPTIONAL TREKKER OUTBACK 58 LT / 42 LT



T512	E161	E172	E201
Borsa interna Waterproof	Rete elastica interna	Schienalino in poliuretano (nero)	Rivestimento interno per fondo e coperchio per valigia 58 Lt
Waterproof Inner bag	Inner elastic carrying net	Polyurethane backrest (black)	Interior lining for the bottom and lid of Trekker Outback 58 Lt

E185	E198	S410
Maniglia universale per bauletto in alluminio	Luce interna di cortesia	Base trolley universale per bauletto Monokey®
Universal handle for aluminum cases	Inner light	Universal Trolley Base for Monokey® Topcases

TREKKER OUTBACK 42 lt

OBKN42A



TREKKER OUTBACK BLACK LINE
OBKN42B



HARD BAGS

SOFT BAGS



INFO



OPTIONAL TREKKER OUTBACK 58 LT / 42 LT



OPTIONAL 42 LT



NEW



E199 + STF500S

Supporto per montare la borraccia su valigie o tubolari con diametro compreso tra i 21 ed i 25mm di diametro.

Removable support to mount the STF500S on the aluminium cases or on tube with a diameter between 21 and 25 mm

STF500S

Borraccia termica in acciaio inox per bevande

Stainless-steel thermal flask

S351

Cinghie Trekker Straps (carico massimo a trazione 75 kg)

Trekker Straps belts, (maximum traction load 75 kg)

T511

Borsa interna Waterproof.

Waterproof Inner bag

E173

Schienaleino in poliuretano (nero)

Polyurethane backrest (black)

E202

Rivestimento interno per fondo e coperchio per valigia 42 lt

Interior lining for the bottom and lid of Trekker Outback 42 lt



TREKKER ALASKA 36 lt



ALA36APACK2

EXTERNAL KNOB

Patent pending



WIRELEASE[®] SYSTEM

Lo sgancio delle valigie dal telaio laterale avviene tramite la rotazione di una manopola esterna, dotata di sistema a cavo (patented), posta direttamente sotto alla serratura Security Lock.

The cases are detached from the side frame by turning an external knob that is equipped with a cable system (patented), placed directly under the Security Lock.



INFO



OPTIONAL



E144	E145	E146	E188	E198	E199 + STF500S
Rete elastica porta oggetti	Coppia di adesivi rifrangenti	Gomme adesive protettive	Maniglia di trasporto	Luce interna di cortesia	Supporto per montare la borraccia su valigie o tubolari con diametro compreso tra i 21 ed i 25mm di diametro.
Elastic carrying net	Pair of reflective stickers	Protective adhesive rubbers	Padded handles	Inner light	Removable support to mount the STF500S on the aluminium cases or on tube with a diameter between 21 and 25 mm

HOLDITEASY SYSTEM®

La Trekker Alaska è dotata di un sistema ad uncino (patent pending) grazie al quale può inclinarsi senza sganciarsi del tutto dal telaio di supporto. Questo sistema meccanico è stato studiato appositamente per evitare cadute accidentali delle valigie e per facilitare le fasi di carico/scarico anche in presenza di un bauletto centrale.

The Trekker Alaska has a hook system (patent pending) allowing it to be tilted without releasing it completely from the frame. This mechanical system has been specifically designed to prevent the cases from being accidentally dropped and to facilitate loading and unloading even if there is a bulky central top-case.



HARD BAGS



SOFT BAGS

TREKKER ALASKA BLACK LINE
ALA36BPACK2

OPTIONAL



UT807C	T506
Borsa cargo, espandibile	Borsa interna waterproof
Expandable cargo-bag	Waterproof inner bag



TREKKER ALASKA 56 lt



ALA56A



TREKKER ALASKA BLACK LINE
ALA56B



WIRELEASE SYSTEM

Lo sgancio della valigia dalla piastra avviene tramite la rotazione di una manopola esterna, dotata di sistema a cavo (patented), posta direttamente sotto alla serratura Security Lock.

The case is detached from the plate by turning an external knob that is equipped with a cable system (patented), placed directly under the Security Lock.



10 KG
MAX LOAD

56 LT
VOLUME

238
559
SIZES

CAPACITY

SECURITY LOCK

OPTIONAL



T512	E201	E198	S410	E199 + STF500S	S351	E161
Borsa interna Waterproof	Rivestimento interno per fondo e coperchio per valigia 56 lt	Luce interna di cortesia	Base trolley universale per bauletti Monokey®	Supporto per montare la borraccia su valigie o tubolari con diametro compreso tra i 21 ed i 25mm di diametro.	Cinghie Trekker Straps (carico massimo a trazione 75 kg)	Rete elastica interna
Waterproof Inner bag	Interior lining for the bottom and lid	Inner light	Universal Trolley Base for Monokey® Topcases	Removable support to mount the STF500S on the aluminium cases or on tube with a diameter between 21 and 25 mm	Trekker Straps belts, (maximum traction load 75 kg)	Inner elastic carrying net



TREKKER ALASKA 44 lt

ALA44A



TREKKER ALASKA BLACK LINE
ALA44B



WIRELEASE SYSTEM®

Lo sgancio della valigia dalla piastra avviene tramite la rotazione di una manopola esterna, dotata di sistema a cavo (patented), posta direttamente sotto alla serratura Security Lock.

The case is detached from the plate by turning an external knob that is equipped with a cable system (patented), placed directly under the Security Lock.



INFO



OPTIONAL



T51	E202	E185	E198	S410	E199 + STF500S	S351
Borsa interna Waterproof.	Rivestimento interno per fondo e coperchio per valigia 44 lt	Maniglia universale per bauletto in alluminio	Luce interna di cortesia	Base trolley universale per bauletto Monokey®	Supporto per montare la borraccia su valigie o tubolari con diametro compreso tra i 21 ed i 25mm di diametro.	Cinghie Trekker Straps (carico massimo a trazione 75 kg)
Waterproof Inner bag	Interior lining for the bottom and lid of 44 lt	Universal handle for aluminum cases	Inner light	Universal Trolley Base for Monokey® Topcases	Removable support to mount the STF500S on the aluminium cases or on tube with a diameter between 21 and 25 mm	Trekker Straps belts, (maximum traction load 75 kg)

HARD BAGS

SOFT BAGS

TREKKER DOLOMITI 46 lt

DLM46A



TREKKER DOLOMITI BLACK LINE
DLM46B



INFO

- 

10 KG
MAX LOAD
- 

46 LT
VOLUME
- 

460
210
250
SIZES
- 

SECURITY LOCK
- 

CAPACITY

OPTIONAL TREKKER DOLOMITI 46 LT / 30 LT



E164	E165	E166	E185	E198	E199 + STF500S
Schienaleino in poliuretano (nero)	Portapacchino in nylon specifico	Rete elastica porta oggetti	Maniglia universale per bauletti in alluminio	Luce interna di cortesia	Supporto per montare la borraccia su valigie o tubolari con diametro compreso tra i 21 ed i 25mm di diametro.
<i>Polyurethane backrest (black)</i>	<i>Specific nylon rack</i>	<i>Elastic carrying net</i>	<i>Universal handle for aluminum cases</i>	<i>Inner light</i>	<i>Removable support to mount the STF500S on the aluminium cases or on tube with a diameter between 21 and 25 mm</i>



TREKKER DOLOMITI 30 lt

TREKKER DOLOMITI BLACK LINE DLM30B

DLM30A



Può contenere una borsa porta computer da 15 pollici

Capacity to store a 15-inch computer bag

Può essere utilizzata sia come top case (compatibile con tutte le piastre Monokey®), che come valigia laterale (compatibile con i telai PL_ PLO_ MK, PLR_ and PLOR_ MK)

Can be used as both a top case (compatible with all Monokey® plates), or as a side case (compatible with PL_ PLO_ MK, PLR_ and PLOR_ MK side frames)

INFO



OPTIONAL TREKKER DOLOMITI 46 LT / 30 LT



OPTIONAL 46 LT

OPTIONAL 30 LT



S410

Base trolley universale per bauletti Monokey®

Universal Trolley Base for Monokey® Topcases

GRT714B

Borsa Cargo impermeabile, 20 lt

Waterproof cargo-bag, 20 lt

S351

Cinghie Trekker Straps (carico massimo a trazione 75 kg)

Trekker Straps belts, (max traction load 75 kg)

T511

Borsa interna Waterproof

Waterproof Inner bag

T514B

Borsa interna

Inner bag

HARD BAGS

SOFT BAGS

TREKKER DOLOMITI 36 lt



DLMK36APACK2

**TREKKER DOLOMITI BLACK LINE
DLMK36BPACK2**



INFO



OPTIONAL



T506	EA120	UT807C	E144	E145	E199 + STF500S	E198
Borsa interna waterproof	Borsa cargo, waterproof	Borsa cargo, espandibile	Rete elastica porta oggetti	Coppia di adesivi rifrangenti	Supporto per montare la borraccia su valigie o tubolari con diametro compreso tra i 21 ed i 25mm di diametro.	Luce interna di cortesia
Waterproof inner bag	Waterproof cargo-bag	Expandable cargo-bag	Elastic carrying net	Pair of reflective stickers	Removable support to mount the STF500S on the aluminium cases or on tube with a diameter between 21 and 25 mm	Inner light

TREKKER II 35 lt



TRK35N



**TREKKER BLACK LINE
TRK35B**

HARD BAGS

SOFT BAGS



Può essere utilizzata sia come top case (compatibile con tutte le piastre Monokey®), che come valigia laterale (compatibile con i telai PL_, PLO_MK, PLR_ and PLOR_MK)

Can be used as both a top case (compatible with all Monokey® plates), or as a side case (compatible with PL___, PLO___MK, PLR___ and PLOR___MK side frames)

INFO



OPTIONAL



NEW

T484C

Borsa
interna

Inner
bag



TREKKER 52 lt

TRK52N



TREKKER BLACK LINE
TRK52B



INFO



OPTIONAL



E142B	E125	E133S	S351	S410	S150	T490B
Portapacchino metallico specifico	Anelli di ancoraggio	Schienaleino specifico in gomma piuma rivestito in tessuto	Cinghie Trekker Straps (carico massimo a trazione 75 kg)	Base trolley universale per bauletti Monokey®	Portapacchino universale in nylon	Borsa interna
Specific metal rack	Rings kit	Specific backrest in polyurethane foam, covered in black fabric	Trekker Straps belts, (maximum traction load 75 kg)	Universal Trolley Base for Monokey® Topcases	Universal nylon rack	Inner bag



TREKKER 33 / 46 lt



TRK46N / TRK33N



TREKKER BLACK LINE
TRK46B / TRK33B

HARD BAGS

SOFT BAGS

INFO TREKKER 33 LT



INFO TREKKER 46 LT



OPTIONAL



NEW



NEW



NEW

E205 + TAN01	E118	E125	S351	E120B / E152	E199 + STF500S	T484C
Supporto in nylon caricato fibra di vetro, per montare la tanica TAN01	Schienalino specifico	Anelli di ancoraggio	Cinghie Trekker Straps (carico massimo a trazione 75 kg)	Portapacchino specifico	Supporto per montare la borraccia su valigie o tubolari con diametro compreso tra i 21 ed i 25mm di diametro.	Borsa interna
Fiberglass reinforced nylon support to mount the tank	Specific backrest	Rings kit	Trekker Straps belts, (maximum traction load 75 kg)	Specific metal rack	Removable support to mount the STF500S on the aluminium cases or on tube with a diameter between 21 and 25 mm	Inner bag

V56 MAXIA 4

V56NNT (carbon look insert)



V56NN (carbon look insert)



V56N (anodized aluminium insert)



V56NT (anodized aluminium insert)



KEYLESS 2.0

Top case **V56 MAXIA 4** disponibile, in tutte le sue versioni, con serratura Keyless 2.0 di serie (cod. **V56_ _ KL**)

Top case **V56 MAXIA 4** available with Keyless 2.0 lock already set up for all the versions (cod. **V56_ _ KL**)

È possibile acquistare separatamente il **KIT KEYLESS 2.0** (cod. **E175**) da installare come optional.

Possibility to buy the **KEYLESS 2.0 KIT** separately, as optional (cod. **E175**)



WATCH THE VIDEO!



COVER: CV47 _ _ _

N902
Gloss Black

R300
Red

G730
Silver

B912
Pearl White

B913
White



AL
ALUMINIUM ARMOR

ONLY FOR
V56N / V56NT

10 KG
MAX LOAD

56 LIT
VOLUME

300-600
SIZES

CAPACITY

SECURITY LOCK



OPTIONAL



CV47	E111	E160	E159	S410	T468C	S150	S351
Cover verniciata	Schienale in gomma piuma rivestito in tessuto	Kit luci stop a led	Portapacchino metallico	Base trolley universale per bauletto Monokey®	Borsa interna	Portapacchino universale in nylon	Cinghie Trekker Straps (carico max a trazione 75 kg)
Painted cover	Backrest in polyurethane foam, covered in fabric	Stop light with led	Metal rack	Universal Trolley Base for Monokey® Topcases	Inner bag	Universal nylon rack	Trekker Straps belts, (max traction load 75 kg)

V47N (anodized aluminium insert)



V47NN (carbon look insert)



V47NNT (carbon look insert)



V47NT (anodized aluminium insert)



HARD BAGS

SOFT BAGS

KEYLESS 2.0

Top case **V47** disponibile, in tutte le sue versioni, con serratura Keyless 2.0 di serie (cod. **V47__KL**)

Top case **V47** available with Keyless 2.0 lock already set up for all the versions (cod. **V47__KL**)

È possibile acquistare separatamente il **KIT KEYLESS 2.0** (cod. **E174**) da installare come optional.

Possibility to buy the **KEYLESS 2.0 KIT** separately, as optional (cod. **E174**)



WATCH THE VIDEO!



COVER: CV47__

- N902**
Gloss Black
- R300**
Red
- G730**
Silver
- B912**
Pearl White
- B913**
White

INFO



- 10 KG**
MAX LOAD
- 47 LT**
VOLUME
- 208-570**
SIZES
- CAPACITY**
- SECURITY LOCK**
- AL**
ALUMINIUM ARMOR
ONLY FOR
V47N / V47NT



OPTIONAL



CV47	E134S	E135	E159	S150	S410	T502B	E132
Cover verniciata	Schienallino specifico in gomma piuma rivestito in tessuto	Kit luci stop a led	Portapacchino metallico	Portapacchino universale in nylon	Base trolley universale per bauletti Monokey®	Borsa interna	Kit di apertura telecomandata specifico
Painted cover	Specific backrest in polyurethane foam, covered in black fabric	Stop light with led	Metal rack	Universal nylon rack	Universal Trolley Base for Monokey® Topcases	Inner bag	Specific remote control

V46

V46N



V46 TECH
V46NT



COVER: CV46 ___

G730
Silver



INFO



OPTIONAL



C46	C46N	C46NL
Cover verniciata <i>Painted cover</i>	Cover nera gofrata <i>Black cover</i>	Cover Verniciabile <i>Paintable cover</i>



T502B	E107B	S150	E95S	E105S	S410	S351
Borsa interna	Portapacchino metallico	Portapacchino universale in nylon	Schienaleino specifico in gomma piuma rivestito in tessuto	Kit luci stop a led	Base trolley universale per bauletto Monokey®	Cinghie Trekker Straps (carico massimo a trazione 75 kg)
<i>Inner bag</i>	<i>Metal rack</i>	<i>Universal nylon rack</i>	<i>Specific backrest in polyurethane foam, covered in black fabric</i>	<i>Stop light with led</i>	<i>Universal Trolley Base for Monokey® Topcases</i>	<i>Trekker Straps belts, (maximum traction load 75 kg)</i>

★ NEW

V40N



V40 TECH
V40NT



HARD BAGS

SOFT BAGS

COVER: C40

G730
Silver

N902
Gloss Black



INFO



OPTIONAL



C40	E131S	S410	E132	E174	C40NL
Cover verniciata	Schienalino specifico in gomma piuma rivestito in tessuto	Base trolley universale per bauletti Monokey®	Kit di apertura telecomandata specifico	Kit Keyless 2.0 per l'apertura della valigia tramite App	Cover verniciabile
Painted cover	Specific backrest in polyurethane foam, covered in black fabric	Universal Trolley Base for Monokey® Topcases	Specific remote control	Kit Keyless 2.0 for the opening of the case through an App	Paintable cover

E22

E22N



INFO



MAX LOAD



VOLUME



SIZES

E460

E460N



INFO



OPTIONAL



E79	E81	T502B
Schienaleino specifico in poliuretano	Portapacchino metallico	Borsa interna
<i>Polyurethane specific backrest</i>	<i>Metal rack</i>	<i>Inner bag</i>



S410	E92
Base trolley universale per bauletto Monokey®	Kit luci stop a led
<i>Universal Trolley Base for Monokey® Topcases</i>	<i>Stop light with Led</i>

HARD BAGS

SOFT BAGS

E360N



INFO



OPTIONAL



E83	E81	S410
Schienaleino specifico in poliuretano	Portapacchino metallico	Base trolley universale per bauletto Monokey®
<i>Polyurethane specific backrest</i>	<i>Metal rack</i>	<i>Universal Trolley Base for Monokey® Topcases</i>

E360

V37

V37N



V37NN (carbon look insert)



V37NNT (carbon look insert)



MONOKEY® SIDE



V37NT (anodized aluminium insert)



INFO



OPTIONAL

WATCH THE VIDEO!



NEW

T443D

Coppia di borse morbide interne

Pair of inner soft bags

V35N



V35 TECH
V35NT



HARD BAGS

SOFT BAGS

COVER: C35

- | | | |
|----------------------------|----------------------------|----------------------------|
| A900
Mat Silver | G730
Silver | B912
Pearl White |
| N902
Gloss Black | G126
Yellow Fluo | |

INFO



OPTIONAL



NEW

C35	T443D
Cover verniciata	Coppia di borse morbide interne
Painted cover	Pair of inner soft bags



E46 RIVIERA



E46N



RIVIERA TECH
E46NT



INFO



OPTIONAL



T502B	SL101
Borsa interna	Chiave Security Lock
Inner bag	Security Lock key

B47 BLADE

B47N



BLADE TECH
B47NT



HARD BAGS

SOFT BAGS

COVER: C47

- | | |
|----------------------------|----------------------|
| G730
Silver | N913
Black |
| B912
Pearl White | B913
White |



INFO



OPTIONAL



C47	E126	E132	E174	E131S	T502B	SL101
Cover verniciata	Kit luci stop a led	Kit di apertura telecomandata specifico	Kit Keyless 2.0 per l'apertura della valigia tramite app	Schienaleino specifico in gomma piuma rivestito in tessuto	Borsa interna	Chiave Security Lock
Painted cover	Stop light with led	Specific remote control	Kit Keyless 2.0 for the opening of the case through an app	Specific backrest in polyurethane foam, covered in black fabric	Inner bag	Security Lock key

KEYLESS 2.0

E470 SIMPLY III

SIMPLY III TECH
E470NT



E470N



COVER: C470_ _ _

G730 Silver
N902 Gloss Black

B912 Pearl White
B913 White

INFO



OPTIONAL



NEW



C470	E94	E110	T502B	SL101	C470NL
Cover verniciata	Kit luci stop a led	Schianalino specifico in poliuretano	Borsa interna	Chiave Security Lock	Cover verniciabile
Painted cover	Stop light with led	Polyurethane specific backrest	Inner bag	Security Lock key	Paintable cover

E370 TECH
E370NT



E370N



HARD BAGS

SOFT BAGS

COVER: C370

G730
Silver

N902
Gloss Black

B912
Pearl White

B913
White

INFO



OPTIONAL



C370	E108	E109	SL101
Cover verniciata	Kit luci stop a led	Schienaleino specifico in poliuretano	Chiave Security Lock
Painted cover	Stop light with led	Polyurethane specific backrest	Security Lock key



E43



E43NML+



AS STANDARD



Dotato di rete elastica portaoggetti, schienalino e tappetino copri fondo. Può contenere due caschi integrali.

Equipped with elastic storage net, backrest and soft touch inner mat. Can hold 2 full-face helmets.



INFO



OPTIONAL



SL101
Chiave Security Lock

Security Lock key

B37 BLADE

B37N

**B37 BLADE TECH
B37NT**



HARD BAGS

SOFT BAGS

COVER: C37

B912
Pearl White



INFO



OPTIONAL



C37	E131	E132	E174	E126	SL101
Cover verniciata	Schianalino	Kit di apertura telecomandata specifico	Kit Keyless 2.0 per l'apertura della valigia tramite App	Kit luci stop a led	Chiave Security Lock
Painted cover	Backrest	Specific remote control	Kit Keyless 2.0 for the opening of the case through an App	Stop light with led	Security Lock key

B360



B360N2



B360 TECH B360NT2



COVER: C360

G730 Silver
B912 Pearl White



INFO



OPTIONAL



C360	E131S	E174	E132	SL101
Cover verniciata	Schienalino specifico in gomma piuma rivestito in tessuto	Kit Keyless 2.0 per l'apertura della valigia tramite App	Kit di apertura telecomandata specifico	Chiave Security Lock
Painted cover	Specific backrest in polyurethane foam, covered in black fabric	Kit Keyless 2.0 for the opening of the case through an App	Specific remote control	Security Lock key

B34N



B34 TECH
B34NT



HARD BAGS

SOFT BAGS

COVER: C34

G730

Silver



INFO



OPTIONAL



E131S	SL101	E132	C34
Schienellino specifico in gomma piuma rivestito in tessuto	Chiave Security Lock	Kit di apertura telecomandata specifico	Cover verniciata
Specific backrest in polyurethane foam, covered in black fabric	Security Lock key	Specific remote control	Painted cover



E340 VISION

E340 VISION TECH
E340NT



E340N



 INFO



 OPTIONAL



E196	SL101	C340NL
Schienaleino specifico in poliuretano	Chiave Security Lock	Cover verniciabile
Polyurethane specific backrest	Security Lock key	Paintable cover

B32NML



HARD BAGS

SOFT BAGS

INFO



OPTIONAL



E195

Schianalino specifico in poliuretano

Polyurethane specific backrest

SL101

Chiave Security Lock

Security Lock key



C30



C30N



**C30 TECH
C30NT**



 **INFO**



 **OPTIONAL**



SL101
Chiave
Security Lock
Security
Lock key

B330



B330N



**B330 TECH
B33NT**

HARD BAGS

INFO



OPTIONAL



E176

Schianalino specifico in poliuretano
Polyurethane specific backrest

SOFT BAGS

E300N2



E300N2



**E300N2
TECH**

INFO



OPTIONAL



E197

Schianalino specifico in poliuretano
Polyurethane specific backrest

SL101

Chiave Security Lock
Security Lock key

C340NL

Cover verniciabile
Paintable cover

B29



B29N2

INFO



**B29 TECH
B29N2**



OPTIONAL



E176

Schienaleino specifico in poliuretano
Polyurethane specific backrest

B27



B27NMAL

INFO



OPTIONAL



E132

Kit di apertura telecomandata specifico
Specific remote control

SL101

Chiave Security Lock
Security Lock key

E147

Schienaleino specifico in poliuretano
Polyurethane specific backrest

TREKKER OUTBACK ATV

HARD BAGS

SOFT BAGS



OBK110A



Valigia Trekker Outback per quad, 110 litri di volume, con sistema di fissaggio "fixed system" direttamente sul portapacchi del quad.

- Struttura in alluminio e bordi in alluminio profilato. Doppia cerniera
- Coperchio piano removibile e quattro passa cinghia
- Chiusura Security Lock con tappo copripolvere di serie
- Maniglie in acciaio inox per il trasporto e tappetino interno

INFO



Trekker Outback case for quad bike, 110 lt volume, with "fixed system" fitting structure, to be fixed directly to the rear rack of the quad.

- Aluminium design with edges in profiled Aluminium. Double hinge
- Flat removable lid with four clamps
- Security Lock closure with dust cap as standard
- Handles in stainless steel for transportation and inner mat

OPTIONAL



OBK110KIT

Kit universale per il fissaggio del baule OBK110 su portapacchi di ATV realizzati con tubolare di diametro compreso tra i 18mm ed i 25mm

Universal fitting kit for mounting the OBK110 on the carrier of ATV with a diameter steel tube of between 18mm and 25 mm



S351

Cinghie Trekker Straps (carico massimo a trazione 75 kg)

Trekker Straps belts, (maximum traction load 75 kg)

UT804

Borsa Cargo impermeabile, 80 lt

Waterproof Cargo bag 80 lt



INNER BAGS



T443D



INFO



Coppia di borse morbide interne per bauletto V35 / V37 Monokey® Side

Pair of inner soft bags for V35 / V37 cases Monokey® Side

NEW

T468C

INFO 



Borsa interna, estensibile, per valigie V56 Maxia 4, E55 Maxia 3 ed E52 Maxia

Inner and extendable bag for V56 Maxia 4, E55 Maxia 3 and E52 Maxia Cases



NEW

T484C

INFO 



Borsa interna, estensibile, per valigie Trekker TRK33, TRK35 e TRK46

Inner and extendable bag for Trekker Cases TRK33, TRK35 and TRK46



NEW

T490B

INFO 



Borsa interna per valigia Trekker TRK52

Inner bag for Trekker TRK52



T502B



INFO



Borsa interna per valigie V47, V46, E41 Keyless, E460, E360, E45, B47 Blade, E470 Simply III, E450 Simply II

Inner bag for V47, V46, E41 Keyless, E460, E360, E45, B47 Blade, E470 Simply III, E450 Simply II cases

T514B



INFO



Borsa interna, estensibile, per valigie DLM30 Trekker Dolomiti

Inner and extendable bag for Trekker Cases DLM30 Trekker Dolomiti.

T506



INFO



Borsa interna waterproof 35 lt. per valigia Trekker Outback 37 lt, Trekker Dolomiti 36 lt e Trekker Alaska 36 lt

Waterproof inner bag 35 lt. for Trekker Outback 37 lt, Trekker Dolomiti 36 lt and Trekker Alaska 36 lt

La borsa può essere usata anche esternamente agganciandola con gli elastici in dotazione sul portapacchi o sulla sella.
It can be used on the lid of the top-case or as a saddle bag, fixing it with standard elastic straps.

T507

INFO



Borsa interna waterproof 45 lt. per valigia Trekker Outback 48 lt

Waterproof inner bag 45 lt. for Trekker Outback 48 lt



La borsa può essere usata anche esternamente agganciandola con gli elastici in dotazione sul portapacchi o sulla sella.

It can be used on the lid of the top-case or as a saddle bag, fixing it with standard elastic straps.

T511

INFO



Borsa interna Waterproof per valigia Trekker Outback 42 lt e Trekker Dolomiti 46 lt.

Waterproof Inner bag for Trekker Outback 42 lt and Trekker Dolomiti 46 lt.



La borsa può essere usata anche esternamente agganciandola con gli elastici in dotazione sul portapacchi o sulla sella.

It can be used on the lid of the top-case or as a saddle bag, fixing it with standard elastic straps.

T512

INFO



Borsa interna Waterproof per valigia Trekker Outback 58 lt

Waterproof Inner bag for Trekker Outback 58 lt



La borsa può essere usata anche esternamente agganciandola con gli elastici in dotazione sul portapacchi o sulla sella.

It can be used on the lid of the top-case or as a saddle bag, fixing it with standard elastic straps.

SOFT BAGS



WEIGHTLESS RANGE

The WEIGHTLESS range use the MONOKEY® fixing system and combine their characteristic lightness with an aerodynamic design that makes them particularly suitable on board touring motorcycles. The essential and newest design, featuring an elegant “total black” look and diamond tip texture of the external shell, is joined by advanced technical features.

WL901 WEIGHTLESS



Valigia termoformata espandibile nera, 29/34 lt
29/34 lt, expandable top case, thermoformed, black

WL900 WEIGHTLESS



Coppia di valigie laterali termoformate, 25 lt
Pair of thermoformed side case, 25 lt

GIVI

EXPLORE. ENJOY.

X-LINE RANGE

NEW GIVI X-LINE bags are appreciated by those seeking accessories which combine reliability, strength, refined design and, above all, comfort. As the finishing touch to its technical offer, GIVI has produced a series of highly useful motorcycle accessories to perfect your travel experience, all in the pursuit of top performance and total safety.

XL01



Borsa cargo water resistant, estensibile da 15 a 20 lt
Expandable water resistant cargo bag, 20 lt

XL02



Borsa cargo roll-top da sella water resistant, 35 lt
Expandable water resistant roll-top saddle cargo bag, 35 lt

XL03



Borsa cargo roll-top da sella, 52 lt
Expandable water resistant roll-top saddle cargo bag, 52 lt

XL04 Tanklock



Borsa da serbatoio Tanklock, 20 lt
Tanklock tank bag, 20 lt
Specifica per / Specific for BMW R 1200 GS (13 > 18) - BMW R 1250 GS (19 > 21) - BMW R 1200 GS Adv. (14 > 18) - BMW R 1250 GS Adv. (19 > 21) - KTM 1290 Adv. S e R (21).

XL05 Tanklock



Borsa da serbatoio Tanklock, 18 lt / TANKLOCK tank bag, 18 lt
Specifica per / Specific for Honda CRF1000L Africa Twin (16 > 19) / CRF1000L Africa Twin Adventure Sports (18 > 19) / CRF1100L Africa Twin (20 > 21) / CRF1100L Africa Twin Adventure Sports (20 > 21).

XL06 Tanklock



Borsa da serbatoio Tanklock, 20 lt
Universal TANKLOCK tank bag, 20 lt

XL07



Borsa da sella water resistant, 12 lt
Water resistant saddle bag, 12 lt

SPORT-T RANGE

A line of semi-rigid bags designed for “quick-tourism”. Developed to obtain compact volumes and shapes with sports lines. The Sport-T range is particularly suitable for road and sport-touring bikes, with medium to medium/small volumes and technical fabrics laminated and with a reinforced structure (water-resistant, with UV protection). Tanklock and Multilock systems patented by GIVI adds further practicality of use, making the fitting/release system fast and secure.

ST604 Multilock



Coppia di borse laterali termoformate Multilock, 22 lt
Pair of thermoformed Multilock side bags, 22 lt

ST605B TanklockED



Borsello da serbatoio TanklockED, 5 lt
TanklockED tank bag, 5 lt

ST606



Zaino con guscio termoformato, 22 litri
Thermoformed rucksack, 22 lt

ST607B



Borsa da sella, 22 lt
Saddle bag, 22 lt

ST608B



Borsello da gamba termoformato
Thermoformed leg wallet

ST609 Easylock



Coppia di borse laterali termoformate Easylock, 22 lt
Pair of thermoformed Easylock side bags, 22 lt

ST610 Seatlock



Borsello da sella Seatlock, 10 lt
Seatlock seat bag, 10 lt

ST611 Tanklock



Borsello da serbatoio Tanklock, 6 lt
Tanklock tank bag, 6 lt

ST612B Tanklock



Borsello da serbatoio Tanklock, 15 lt
Tanklock tank bag, 15 lt

ULTIMA-T RANGE

The Ultima-T series offers the best performance in terms of both protection and comfort, perfecting the use of mechanical and universal mounting systems for a series of extremely versatile and useful cargo solutions and is a range dedicated to the most demanding of motorcycle tourers.

UT805



Borsone Cargo, 35 lt
Cargo bag, 35 lt

UT806



Borsa posteriore, 65 lt
Top bag, 65 lt

UT807C



Borsa cargo, 25 lt, espandibile
Expandable cargo bag, 25 lt

UT809 TanklockED



Borsa da serbatoio TanklockED, 20 lt
TanklockED tank bag, 20 lt

UT810 TanklockED



Borsa da serbatoio TanklockED, 25 lt
TanklockED tank bag, 25 lt

UT813



Borsa cargo da sella, 8 lt
Saddle bag, 8 lt

CANYON RANGE

The Canyon Range is a new line of completely waterproof bags, produced for off-road and touring. Especially suitable for light bikes such as Enduro and Superbikes, this specific range aims to meet the needs of the off-road biker, thanks to its technical features designed for enduro use.

GRT709	GRT712B	GRT714B 	GRT715	GRT716	GRT717B
Coppia di borse laterali impermeabili, 35+35 lt Pair of water resistant side bags, 35 lt on each side	Borsone impermeabile 40 lt, Water resistant cylinder seat bag 40 lt	Borsa Cargo cilindrica, impermeabile, 20 lt Cylindrical, water resistant cargo bag, 20 lt	Borsa da serbatoio impermeabile con base di aggancio/sgancio rapido specifica, 20 lt Water resistant tank bag with specific base for quick attachment/detachment, 20 lt	Borsello da serbatoio impermeabile, 6 lt Water resistant tank bag, 6 lt	Borsello porta attrezzi Universal tools bag
GRT718	GRT719	GRT720	GRT721	GRT722	
Coppia di borse laterali impermeabili, 15+15 lt Pair of water resistant side bags, 15 lt on each side	Zaino con sacca Hydrapack inclusa, impermeabile Water resistant rucksack, with integrated water bag	Coppia di borse laterali MONOKEY, impermeabili, 25+25 lt Pair of MONOKEY water resistant side bags, 25 lt on each side	Base da sella universale, per il fissaggio modulare di diverse borse Universal saddle base, for the modular fixing of different bags	Borsa Cargo water resistant, 8 lt. Cargo water resistant bag, 8 lt.	

EASY-T RANGE

The Easy-T range of motorcycle bags is a restyling of the "entry-level" Easy line and includes a wide range of bags for general touring. The materials used (developed in accordance with the new Reach regulations) and the technical features designed for maximum efficiency ensure a high reliability of these bags, suitable for all 2-wheel users.

EA100B	EA101B	EA103B	EA104B	EA107B	EA114			
Coppia di borse laterali grandi, 40 lt Pair of large saddle bags, 40 lt	Coppia di borse laterali piccole, 30 lt Pair of small saddle bags, 30 lt	Borsa da serbatoio divisibile, 25+15 lt Modular tank bag, 25+15 lt	Zaino portacasco, 22 lt Rucksack with helmet holder, 22 lt	Borsa rullo da sella, 35 lt Seat roll-bag, 35 lt	Borsa rullo impermeabile, 30 lt Water resistant cylinder bag, 30 lt			
EA115	EA119BK	EA120	EA121	EA125	EA126	EA127		
Borsone impermeabile, 40 lt Water resistant cylinder seat bag, 40 lt	Borsone impermeabile 60 lt, colore nero Water resistant cylinder seat bag 60 lt, black colour	Borsa cargo, 15 lt Cargo bag, 15 lt	Zaino, 18 lt Backpack, 18 lt	Marsupio water resistant Water resistant waist bag	Borsone impermeabile 80 lt Water resistant cylinder seat bag 80 lt	Coppia di borse laterali, 25+25 lt Pair of saddle bags, 25 lt on each side		
EA129	EA130	EA131 Tanklock	EA132	EA133	EA135 	EA136 	EA138 	EA139 
Zaino termoformato Thermoformed backpack	Borsa da serbatoio magnetica, 26 lt Magnetic tank bag, 26 lt	Borsa da serbatoio Tanklock, 26 lt Tanklock tank bag, 26 lt	Borsa cargo da sella, 11 lt Saddle bag, 11 lt	Bisacce laterali impermeabili, 25+25 lt Water resistant side bags, 25 lt on each side	Borsa da tunnel per scooter, 15 lt Tunnel bag for scooter, 15 lt	Borsa tunnel, 23 lt Tunnel bag, 23 lt	Borsello da serbatoio universale, 6 lt Small-size universal tank-bag, 6 lt	Borsello da gamba Leg wallet

EA140



Borsello da gamba XL
Leg wallet XL

EA141



Borsa da serbatoio, 10 lt.
specifica per / Tank bag 10 lt.
specific for: Honda HONDA NC
750 X (16>20)

EA142



Borsa da serbatoio con base
specifica per moto enduro
Tank bag with specific base
for Enduro bikes

EA143 Tanklock



Borsa da serbatoio Tanklock per
moto enduro, 25 lt
Tanklock tank bag for Enduro
bikes, 25 lt

EA144 Tanklock



Borsello tanklock, 5 lt
Tanklock tank bag, 5 lt

EA145



Marsupio
Waist-bag

EA148



Zaino, 20 lt
Backpack, 20 lt

XSTREAM RANGE

Sporty look from the express line for those who are not willing to compromise in terms of reliability and comfort. All materials will be developed in accordance with the new Reach regulations except the main fabric of the new Xstream products which will be treated anti-UV.

XS306 Tanklock

XS307 Tanklock

XS308 Tanklock

XS315

XS319

XS320 Tanklock

XS5112E

XS5112R



Borsa da serbatoio
Tanklock, 25 lt
Tanklock tank bag 25 lt



Borsa da serbatoio
Tanklock, 15 lt
Tanklock tank bag 15 lt



Borsa da serbatoio
Tanklock, 20 lt
Tanklock tank bag 20 lt



Tasche porta attrezzi
per portapacchi:
Tool case pockets for rear
rack specific for
BMW R1200GS (13>18) /
R1250 GS (19>21)



Borsa da serbatoio
Tanklock, 3 lt
Tanklock tank bag 3 lt



Borsa da serbatoio Tanklock,
15 lt / Tanklock tank bag
15 lt, Honda CRF1000L
Africa Twin (16>19) e Sport
Adventure (18>19) / CRF1100L
Africa Twin (20>21) e Sport
Adventure (20>21) /
Kawasaki Versys 650 (15>21)



Coppia di borse per
paramotore / Pair of
panniers for engine
guard specific for:
BMW R1200GS
Adventure (14>18) /
R1250GS
Adventure (19>21)



Borsa porta attrezzi per
portapacchi / Tool bag for
rear rack specific for:
BMW R1200GS Adven-
ture (14>18) / R1250GS
Adventure (19>21)

CORIUM RANGE

Corium, the new line of soft bags, was designed for classic, retro or café racer motorcycles. The line consists of 5 highly versatile models, all with medium to medium-small load capacities, made by combining robust technical materials with two different colours of PU, in a retro design.

CRM101

CRM102

CRM103

CRM104

CRM105

CRM106

CRM107



Zaino trasformabile in borsa
da sella, 18 lt
Rucksack which can also be
used as a saddle bag, 18 lt



Borsa laterale singola, 16 lt
Single side bag, 16 lt



Borsa da serbatoio
magnetica, 8 lt
Magnetic tank bag, 8 lt



Borsello da gamba dal
design classico, 3 lt
Classically designed leg
bag, 3 lt



Fascia da sella per il
montaggio delle borse laterali
CRM102 e CRM106
Saddle strap to fasten the
CRM102 and CRM106 side bags



Borsa laterale singola, 13 lt
Single side bag, 13 lt



Cuscino da sella da utilizzare
come copertura della fascia
CRM105
Seat pads for covering the
CRM105 saddle strap

METRO-T RANGE

A line of semi-rigid bags, suitable for bikes with a classic frame, in a retro or café racer style. Thanks to the versatility of the models in the range, with medium - medium/small volumes and technical fabrics (water-resistant, with UV protection) these bags are suitable for touring-urban use and therefore can be used with all bike models, from the classics, to more modern naked bikes.

MT501 Multilock

MT501S Multilock

MT505 Tanklock



Coppia di borse laterali termofornate
Multilock, 18 lt
Pair of thermoformed Multilock side
bags, 18 lt



Borsa laterale singola termofornata
Multilock, 18 lt
Thermoformed single side bag
Multilock side bags, 18 lt



Borsello da serbatoio Tanklock,
termofornato, 5 lt
Tanklock tank bag thermoformed,
5 lt

WL900 WEIGHTLESS

AERODYNAMIC DESIGN



ERGONOMIC HANDLE



WATCH THE VIDEO!



Coppia di borse laterali MONOKEY® semirigide, 25 lt, dotate di sacco interno waterproof removibile.

Pair of MONOKEY® semi-rigid side bags, 25 ltr, equipped with removable waterproof inner bag with IPX5 impermeability

INFO



MONOKEY® SYSTEM Compatibile con i telai laterali PL_ __, PLR_ __, PLO_ __ MK, PLOR_ __ MK.

Compatible with the tubular side-case holders PL_ __, PLR_ __, PLO_ __ MK, PLOR_ __ MK.



WL901 WEIGHTLESS

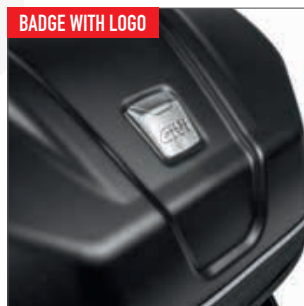

HARD BAGS

SOFT BAGS



EXPANDABLE
FROM 29
TO 34 LT



Top-case semirigido con sistema di aggancio MONOKEY®, estensibile da 29 a 34 litri. Può contenere un casco modulare.

Semi-rigid case with MONOKEY® attachment system, expandable from 29 to 34 ltr. Can hold a full-face helmet.

INFO



MONOKEY® SYSTEM

Compatibile con tutte le piastre MONOKEY®.

Compatible with all MONOKEY® plates.



ST604 MULTILOCK*

EXPANDABLE



DETAILS



Coppia di borse laterali termoformate MULTILOCK*, 22 lt.
Da abbinare necessariamente ai telaietti specifici (TST_...)

Pair of thermoformed MULTILOCK* side bags, 22 lt.
To be combined with the specific side soft bags holders (TST_...)

*Patent pending



INFO



RAIN COVER



ST605B TANKLOCKED



SMARTPHONE HOLDER



MOUNTED



HARD BAGS

SOFT BAGS

Borsello da serbatoio TanklockED, 5 lt. **Da abbinare necessariamente alle flange specifiche BF__**

TanklockED tank bag, 5 lt. **To match with motorcycle specific mounting ring (BF__)**

INFO



SIZES



VOLUME



TANKLOCKED



READY TO POWER HUB



REFLECTIVE



RAIN COVER



ERGONOMIC HANDLE



READY TO PADLOCK



WATERPROOF SMARTPHONE HOLDER IPX5



INNER POCKET



SHOULDER STRAP

OPTIONAL



S111 + S110

Kit Power Hub + presa elettrica 12v

Kit Power Hub + 12v electrical handlebar outlet



ST606

POCKET



RAIN COVER



HELMET HOLDER BELT



WATCH THE VIDEO!



Zaino con guscio termoformato, capacità 22 litri.

Rucksack with thermoformed shell, 22 ltr.

INFO

ST607B



RAIN COVER



EXPANDABLE



Borsa da sella espandibile termoformato, adatta a moto sportive, 22 lt.

Expandable thermoformed saddle bag suitable for sporty motorcycles, 22 ltr.

INFO



HARD BAGS

SOFT BAGS

ST608B

DRESSED



DRESSED

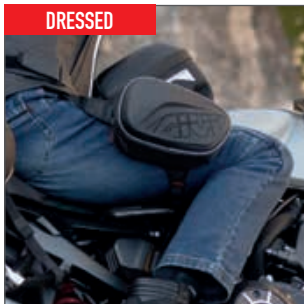

Borsello da gamba termofornato.

Thermoformed leg bag.



INFO



SIZES



UV TESTED



RAIN COVER



INNER POCKET



REFLECTIVE

ST609 EASYLOCK

HANDLE



THERMOFORMED



Coppia di borse laterali EASYLOCK espandibili, termofornate, capacità 25+25 litri. **Da abbinare necessariamente ai telaietti specifici (TE_...)**

*Pair of thermoformed EASYLOCK side bags, 25 + 25 ltr. **To be combined with the specific side soft bags holders (TE_...)***



INFO



SIZES



VOLUME



EASYLOCK



EXPANDABLE



REFLECTIVE



ERGONOMIC HANDLE



INNER POCKET



RAIN COVER



READY TO PADLOCK

ST610 SEATLOCK

HARD BAGS

SOFT BAGS



SHOULDER STRAP



INNER POCKET



Borsa da sella termoformata, 10 lt, dotata di sistema TANKLOCK. Si fissa sulla sella della moto tramite l'utilizzo della base di aggancio universale Seatlock S430, da fissare al posto del passeggero.

Thermoformed saddle bag, 10 ltr, equipped with TANKLOCK system. It is fixed to the seat of the motorbike using the Seatlock S430 universal mounting base, to secure the passenger seat.



INFO



OPTIONAL



S430

Base di aggancio universale Seatlock
Base with universal retaining system Seatlock



ST611 TANKLOCK

SHOULDER STRAP



INNER POCKET



WATCH THE VIDEO!



Borsello da serbatoio TANKLOCK, 6 lt. **Da abbinare necessariamente alle flange specifiche BF_ _**

TANKLOCK tank bag, 6 lt. **To match with motorcycle specific mounting ring (BF_ _)**



OPTIONAL



S111 + S110

Kit Power Hub + presa elettrica 12v

Kit Power Hub + 12v electrical handlebar outlet



ST612 TANKLOCK



RAIN COVER



EXPANDABLE



SHOULDER STRAP



HARD BAGS

SOFT BAGS

Borsello da serbatoio TANKLOCK, 15 lt. **Da abbinare necessariamente alle flange specifiche BF__**

TANKLOCK tank bag, 15 lt. **To match with motorcycle specific mounting ring (BF__)**

INFO



-
-
-
-
-
-
-
-
-
-
-
-
-

WATCH THE VIDEO!



OPTIONAL



S111 + S110

Kit Power Hub + presa elettrica 12v

Kit Power Hub + 12v electrical handlebar outlet





XL01

NEW

EXPANDABLE



POCKET



SHOULDER STRAP



Borsa cargo water resistant, estensibile da 15 a 20 litri. Adattabile al montaggio su: valigie laterali con carica dall'alto e dotate di passacinghia, portapacchi da montare sopra i top case, selle passeggero.

Expandable water resistant cargo bag, expandable from 15 to 20 litres. Can be adapted to fit: top loading side-cases with belt-strap loops, small racks installed over top cases, passenger seats.

INFO





★
NEW

XL02



HARD BAGS

SOFT BAGS

Borsa cargo roll-top da sella water resistant, estensibile da 25 a 35 litri. Adattabile al montaggio su: top case dotati di passacingga, portapacchi da montare sopra i top case, selle passeggero.

Expandable water resistant roll-top saddle cargo bag, expandable from 25 to 35 litres. Can be adapted to fit: top-cases with belt-strap loops, small racks installed over top cases, passenger seats.

INFO





XL03

★
NEW

POCKET



EXPANDABLE



CARGO BAG



Borsa cargo roll-top da sella water resistant, estensibile da 39 a 52 litri. Adattabile al montaggio su: top case dotati di passaciglia, piastra portapacchi e selle passeggero.

Expandable water resistant roll-top saddle cargo bag, expandable from 39 to 52 litres. Can be adapted to fit: top-cases with belt-strap loops, small racks installed over top cases, passenger seats.



INFO



SIZES



VOLUME



UV TESTED



DRY PACK INSIDE



ELASTIC STRAP



EXPANDABLE



ERGONOMIC HANDLE



TRANSFORM



REFLECTIVE



EXTERNAL POCKET



DRAINAGE HOLES



BACKPACK





NEW

XL04



EXPANDABLE



MAP HOLDER



SHOULDER STRAP



Borsa da serbatoio Tanklock estensibile da 15 a 20 litri, specifica per BMW R 1200 GS (13 > 18) - BMW R 1250 GS (19 > 21) - BMW R 1200 GS Adventure (14 > 18) - BMW R 1250 GS Adventure (19 > 21) - KTM 1290 Adventure S e R (20 > 21). **Da abbinare necessariamente alle flange specifiche BF_.**

TANKLOCK tank bag, expandable from 15 to 20 litres, specific for BMW R 1200 GS (13 > 18) - BMW R 1250 GS (19 > 21) - BMW R 1200 GS Adventure (14 > 18) - BMW R 1250 GS Adventure (19 > 21) - KTM 1290 Adventure S e R (20 > 21). **To match with motorcycle specific mounting ring (BF_).**

INFO



HARD BAGS

SOFT BAGS



XL05



EXPANDABLE



SHOULDER STRAP



Borsa da serbatoio Tanklock estensibile da 15 a 18 litri, specifica per Honda CRF1000L Africa Twin (16 > 19) / CRF1000L Africa Twin Adventure Sports (18 > 19) / CRF1100L Africa Twin (20 > 21) / CRF1100L Africa Twin Adventure Sports (20 > 21). **Da abbinare necessariamente alle flange specifiche BF25.**

TANKLOCK tank bag, expandable from 15 to 18 litres, specific for Honda CRF1000L Africa Twin (16 > 19) / CRF1000L Africa Twin Adventure Sports (18 > 19) / CRF1100L Africa Twin (20 > 21) / CRF1100L Africa Twin Adventure Sports (20 > 21). **To match with motorcycle specific mounting ring BF25.**



INFO



SIZES



VOLUME



UV TESTED



TANKLOCK



MAX LOAD



REMOVABLE DRY PACK



WATERPROOF SMARTPHONE HOLDER



EXPANDABLE



REFLECTIVE



READY TO POWER HUB



SHOULDER STRAP



ERGONOMIC HANDLE



EXTERNAL POCKET



DRAINAGE HOLES



★
NEW

XL06



EXPANDABLE



MAP HOLDER



HARD BAGS

SOFT BAGS

Borsa da serbatoio Tanklock universale, estensibile da 15 a 20 litri.
Da abbinare necessariamente alle flange specifiche BF__.

Universal TANKLOCK tank bag, expandable from 15 to 20 litres. To
match with motorcycle specific mounting ring (BF__).

INFO



SIZES



VOLUME



UV TESTED



TANKLOCK



MAX LOAD



REMOVABLE DRY PACK
IPX5



WATERPROOF SMARTPHONE HOLDER
IPX5



EXPANDABLE



REFLECTIVE



READY TO POWER HUB



SHOULDER STRAP



ERGONOMIC HANDLE



EXTERNAL POCKET



DRAINAGE HOLES





XL07

+NEW

EXPANDABLE



ELASTIC LANYARD



SHOULDER STRAP



Borsa da sella water resistant, estensibile da 9 a 12 litri. Adattabile al montaggio su: valigie laterali con carica dall'alto e dotate di passacinghia, portapacchi da montare sopra i top case, selle passeggero.

Water resistant saddle bag, expandable from 9 to 12 litres. Can be adapted to fit: top loading side-cases with belt-strap loops, small racks installed over top cases, passenger seats.

INFO



UT805



HARD BAGS

SOFT BAGS

Borsa posteriore, 35 lt

Top bag, 35 lt

INFO



TOOL POCKET



UT806

BOTTOM

EXTRA PROTECTIVE
LINING

Borsa posteriore, 65 lt

Top bag, 65 lt

INFO



SIZES



VOLUME



UV TESTED

IPX5
DRY PACK INSIDE

BELTS

ERGONOMIC
HANDLE

REFLECTIVE



INNER POCKET



SHOULDER STRAP



REINFORCED



TOOL POCKET



UT807C



EXPANDABLE



EXTRA PROTECTIVE LINING



MODULABLE WITH UT807B



Borsa cargo, 20 litri, espandibile. Studiata per ogni genere di moto, ad utilizzo "gran-turismo" ed "adventure".

Expandable cargo bag, 20 lt. Created for all kinds of bikes and for "touring" and "adventure" use

INFO



-
-
-
-
-
-
-
-
-
-
-



HARD BAGS

SOFT BAGS

UT809 TANKLOCKED

TABLET HOLDER



EXTRA PROTECTIVE LINING



Borsa da serbatoio TanklockED, 20 lt. **Da abbinare necessariamente alle flange specifiche BF__**

TanklockED tank bag, 20 lt. To match with motorcycle specific mounting ring (BF__)



INFO



OPTIONAL



S111 + S110

Kit Power Hub + presa elettrica 12v

Kit Power Hub + 12v electrical handlebar outlet



UT810 TANKLOCKED



WATCH THE VIDEO!



Borsa da serbatoio TanklockED, 25 lt. Da abbinare necessariamente alle flange specifiche BF__

TanklockED tank bag, 25 lt. To match with motorcycle specific mounting ring (BF__)

INFO



OPTIONAL



S111 + S110

Kit Power Hub + presa elettrica 12v

Kit Power Hub + 12v electrical handlebar outlet



HARD BAGS

SOFT BAGS

UT813

REFLECTIVE PARTS



WATERPROOF INNER BAG



Borsa cargo da sella e portapacchi estensibile, con sacco interno waterproof, 8 lt

Expandable cargo bag for both saddle and luggage rack, with waterproof inner bag, 8 lt

INFO

Dotata di stampe a motivi rifrangenti per una maggiore visibilità e cordino elastico riflettente multiuso

Equipped with print incorporating a reflective motif, for increased visibility, and with multi-purpose reflective elastic cord



GRT709 CANYON



HARD BAGS

SOFT BAGS

Coppia di borse laterali, 35+35 litri. Studiate per moto Enduro off-road. Sistema di aggancio/sgancio rapido con serratura chiave Security Lock (eventualmente unificabile a quella del bauletto, base trolley, cassetta porta attrezzi, con i kit SL102-SL103-SL105).

Pair of side bags, 35 + 35 lt. Designed for enduro and off-road motorcycles. Quick release from the mounts, with GIVI Security Locks (can be keyed the same as the top case, trolley base or the toolbox using the SL102, SL103 or SL105 kits).

WATCH THE VIDEO!



INFO



Sistema di fissaggio:

Borse dotate di piastra in nylon per il fissaggio su portavaligie laterali tipo PL, PLO, PLR, PLOR, PL...CAM, PLO...CAM, PLR...CAM, PLOR...CAM ed altri tipi di telai tubolari originali.

Fixed system:

Bags equipped with a nylon plate that can be installed on side case holders PL, PLO, PLR, PLOR, PL...CAM, PLO...CAM, PLR...CAM, PLOR...CAM and manufacturer original side case holders.



GRT712B

INNER



AIR VALVE



MODULABLE WITH T520



Borsone Cargo waterproof, 40 lt

Waterproof Cargo bag, 40 lt



INFO



SIZES



40L

VOLUME



UV TESTED



IPX5
WATER RESISTANT



AIR VALVE



ERGONOMIC
HANDLE



REFLECTIVE



INNER POCKET



SHOULDER STRAP



BELTS WITH CLIPS



OPTIONAL



T518	T520	S350	S351
Set da viaggio	Borsa cargo supplementare Dry bag, 18 lt.	Cinghie Trekker Straps (carico massimo a trazione 100 kg)	Cinghie Trekker Straps (carico massimo a trazione 75 kg)
Travel set	Additional cargo bag Dry bag, 18 lt.	Trekker Straps belts, (max. traction load 100 kg)	Trekker Straps belts, (maximum traction load 75 kg)



AIR RELEASE VALVE



SHOULDER STRAP

HARD BAGS

SOFT BAGS

Borsa Cargo cilindrica, impermeabile, 20 lt

Cylindrical, waterproof cargo bag, 20 lt

INFO



SIZES



VOLUME

IPX5
WATER RESISTANT

ELASTIC STRAP



AIR VALVE

ERGONOMIC
HANDLE

SHOULDER STRAP



MODULAR



REFLECTIVE

OPTIONAL



S350

Cinghie

Trekker Straps (carico massimo a trazione 100 kg)

Trekker Straps belts,
(maximum traction load 100 kg)

S351

Cinghie

Trekker Straps (carico massimo a trazione 75 kg)

Trekker Straps belts,
(maximum traction load 75 kg)

GRT715

POCKET



TABLET HOLDER



SPECIFIC BASE



Borsa serbatoio waterproof nera, 20 litri, con interno di colore giallo. Dotata di base specifica per aggancio e sgancio rapido.

Waterproof tank bag, 20 ltr, colour black with yellow inner. Equipped with specific base for quick attachment/detachment.

INFO

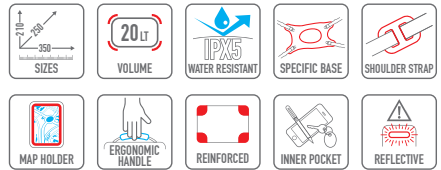



HARD BAGS

SOFT BAGS

Borsa serbatoio waterproof nera, 6 litri, con interno di colore giallo.

Waterproof tank bag, 6 ltr, colour black with yellow inner.

INFO



GRT717B

WATERPROOF



INNER



Borsello porta attrezzi da sella nero, con interno di colore giallo.

Universal tool bag, colour black with yellow inner. Aimed at offroad Enduro motorcycles.

INFO



GRT718



HARD BAGS

SOFT BAGS

Coppia di borse laterali, 15+15 litri

Pair of side bags (15 Lt on each side)

INFO



GRT719

HANDLE



WATER BAG



Zaino con sacca idrica integrata, capacità 3 litri

Rucksack with integrated water bag, 3 ltr.

INFO



T523 INCLUDED



GRT720 CANYON



MONOKEY FITTING SYSTEM



FRONT FLAP



HARD BAGS

SOFT BAGS

Coppia di borse laterali water resistant, 25+25 lt. Studiate da Givi per moto Enduro off-road, sono dotate di sistema di aggancio/sgancio Monokey®, compatibili con i portavaligie laterali tubolari PL____, PLR____, PLO____MK, PLOR____MK.

Pair of water-resistant side bags, 25+25 lt. Designed by Givi for off-road Enduro motorbikes, they are equipped with Monokey® hooking/unhooking system, compatible with the tubular side case holders PL____, PLR____, PLO____MK, PLOR____MK.

MODULABLE

WITH GRT722



INFO



INNER



GRT721 CANYON-BASE

WITH GRT714 AND GRT722



MOUNTED



Base da sella universale, per il fissaggio modulare di diverse borse, particolarmente adatto all'utilizzo su moto Enduro e Maxi Enduro. Permette di fissare diversi carichi laterali e superiori: modulabile con borsa rullo GRT714B, borsa cargo GRT722 e dry bag T520.

Universal saddle base, for the modular fixing of different bags, particularly suitable for use on Enduro and Maxi Enduro motorbikes. Allows various side and top loads to be fixed: modular with GRT714B roller bag, GRT722 cargo bag and T520 dry bag.

QUOTES

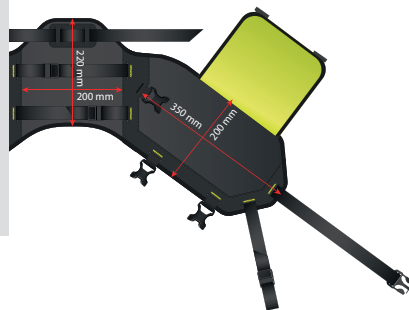

INFO



UV TESTED



MODULABLE



BELTS WITH CLIPS



MODULABLE



REFLECTIVE



OPTIONAL



GRT714

Borsa Cargo cilindrica, impermeabile, 20 lt

Cylindrical, waterproof cargo bag, 20 lt

GRT722

Borsa Cargo water resistant, 8 lt

Cargo water resistant bag, 8 lt.

T520

Borsa cargo Dry bag, 18 lt.

Additional cargo bag Dry bag, 18 lt.

GRT722



INNER



MOUNTED



HARD BAGS

SOFT BAGS

Borsa Cargo water resistant, 8 lt. Può essere montata sul paramotore delle Maxi Enduro come carico aggiuntivo, o sulla sella e portapacchi.

Cargo water resistant bag, 8 lt. It can be mounted on the Maxi Enduro motor protector as additional load, or on the saddle and carrier

INFO



SIZES



VOLUME



UV TESTED

IPX5
WATER RESISTANT

MODULABLE



BELTS



BELTS WITH CLIPS



REFLECTIVE



INNER



EA100B

SHOULDER STRAP



POCKET



Coppia di borse laterali grandi espandibili, 40 lt
 Pair of large expandable saddle bags, 40 lt



INFO

-
-
-
-
-
-
-
-
-

DETAILS



EA101B



Coppia di borse laterali piccole espandibili, 30 lt
 Pair of small expandable saddle bags, 30 lt

INFO



HARD BAGS

SOFT BAGS

EA103B

RAIN COVER



MODULABLE



RUCKSACK



Borsa da serbatoio universale divisibile, dotata di magneti, 25+15 lt

Modular tank bag (universal), with magnets, 25+15 lt



INFO



SIZES



VOLUME



4 MAGNETS



MODULAR



EXPANDABLE



TRANSFORM



MAP HOLDER



RAIN COVER



EMERGENCY STRAP



REFLECTIVE



REINFORCED



OPTIONAL



S111 + S110

Kit Power Hub + presa elettrica 12v

Kit Power Hub + 12v electrical handlebar outlet



T460B

TFS (Tank Fitting System)





HARD BAGS

SOFT BAGS

Zaino portacasco espandibile, 22 Lt

Expandable rucksack with helmet holder, 22 Lt

INFO



EA107B

RAIN COVER



SHOULDER STRAP



Borsa rullo da sella, 35 lt

Seat roll-bag, 35 lt



INFO





EA114FL
neon yellow



EA114GR
black-red



EA114CM
camouflage
yellow



EA114BK
black colour

Borsa rullo impermeabile da sella o portapacchi, 30 lt
Water resistant cylinder seat bag, 30 lt

INFO



OPTIONAL

**S350**

Cinghie
Trekker Straps (carico
massimo a trazione 100 kg)
Trekker Straps belts,
(maximum traction load
100 kg)

**S351**

Cinghie
Trekker Straps (carico
massimo a trazione 75 kg)
Trekker Straps belts,
(maximum traction load
75 kg)



EA115



EA115FL
neon yellow



EA115CM
camouflage
yellow



EA115BK
black colour



EA115GR
black-red

Borsone impermeabile da sella 40 lt

Water resistant cargo bag, 40 lt

INFO



OPTIONAL



S350

Cinghie
Trekker Straps (carico
massimo a trazione 100 kg)
Trekker Straps belts,
(maximum traction load
100 kg)

S351

Cinghie
Trekker Straps (carico
massimo a trazione 75 kg)
Trekker Straps belts,
(maximum traction load
75 kg)



HARD BAGS

SOFT BAGS

Borsone impermeabile da sella 60 lt
Water resistant cylinder seat bag, 60 lt

INFO



OPTIONAL



S350

Cinghie
Trekker Straps (carico massimo a trazione 100 kg)
Trekker Straps belts, (maximum traction load 100 kg)

S351

Cinghie
Trekker Straps (carico massimo a trazione 75 kg)
Trekker Straps belts, (maximum traction load 75 kg)

EA120

MOUNTED ON OBKN37



REAR MESH POCKET



Borsa cargo waterproof, 15 litri

Waterproof cargo bag 15 ltr.

INFO

SHOULDER STRAP

EA121



HARD BAGS

SOFT BAGS

Zaino rullo waterproof, 18 litri

Waterproof backpack, 18 ltr.

INFO



EA125

DRESSED



REFLECTIVE PARTS



Marsupio water resistant regolabile in vita

Water resistant adjustable waist bag

INFO



EA126

MOUNTED



OPTIONAL



S350

Cinghie Trekker Straps (carico massimo a trazione 100 kg)
Trekker Straps belts, (maximum traction load 100 kg)

Borsone Cargo waterproof, 80 lt

Waterproof Cargo bag, 80 lt

INFO





EXPANDABLE



FRONTAL POCKET

HARD BAGS

SOFT BAGS

Coppia di borse laterali espandibili, 30 lt. Dotato di cinghie da porre sotto alla sella, per permettere l'aggancio delle borse tramite sistema a doppio anello.

Pair of expandable side bags (30 lt on each side).

Equipped with straps to be placed under the saddle, to allow the hooking of the bags through a double ring system.



INFO



SIZES



VOLUME



EXPANDABLE



DRY PACK INSIDE



REINFORCED



BELTS



REFLECTIVE



INNER POCKET



EA129

RAIN COVER



SIDE POCKET



SIDE POCKET



ALLOW THE TRANSPORT
ON TROLLEY



Zaino, 15 litri

Backpack, 15 ltr.



INFO



SIZES



VOLUME



PC POCKET



INNER POCKET



ERGONOMIC HANDLE



REFLECTIVE

3 STORAGE COMPARTMENTS





Borsa da serbatoio universale espandibile, dotata di magneti, 26 lt. **Modulabile con EA132.**

Universal expandable tank bag, with magnets, 26 lt. **Modulable with EA132.**

INFO



**MODULABLE
WITH EA132**



EA131 TANKLOCK

RAIN COVER



DETAIL



EXPANDABLE



Borsa da serbatoio Tanklock espandibile, 26 lt.

Da abbinare necessariamente alle flange specifiche BF_ _

Tanklock expandable tank bag, 15 lt. To match with motorcycle specific mounting ring (BF_ _)



INFO



WATCH THE VIDEO!





MODULABLE
WITH EA130



Borsa da coda universale, 11 lt. **Modulabile con EA130.**

Universal tail bag, 11 lt. **Modulable with EA130.**

INFO



HARD BAGS

SOFT BAGS

EA133

SHOULDER STRAP



FRONT POCKET



Coppia di borse laterali waterproof, 25+25 lt. Dotato di cinghie da porre sotto alla sella, per permettere l'aggancio delle borse tramite sistema a doppio anello.

Waterproof side bags (25 lt on each side). Equipped with straps to be placed under the saddle, to allow the hooking of the bags through a double ring system.



INFO



SIZES



VOLUME



DRY PACK INSIDE



SHOULDER STRAP



ERGONOMIC HANDLE



BELTS



REFLECTIVE



INNER POCKET

CLOSURE





EA135



SHOULDER STRAP



DETAILS



MOUNTED



Borsa da tunnel per scooter, 15 lt
Tunnel bag for scooter, 15 lt

INFO



HARD BAGS

SOFT BAGS

EA136

★
NEW

RAIN COVER



SHOULDER STRAP



MAP HOLDER



Borsa da tunnel/sella, 23 litri.

Tunnel/Seat bag, 23 ltr.

INFO

SIZES



VOLUME



RAIN COVER



SHOULDER STRAP



INNER POCKET



REFLECTIVE



ERGONOMIC HANDLE



BELTS WITH CLIPS





HARD BAGS

SOFT BAGS

Borsello da serbatoio universale, con magneti, 6 lt

Small-size universal tank-bag, with magnets, 6 lt

INFO



OPTIONAL



T460B	S111 + S110
TFS (Tank Fitting System)	Kit Power Hub + presa elettrica 12v
	Kit Power Hub + 12v electrical handlebar outlet

EA139

+ NEW



Borsello da gamba con tasca interna e anteriore

Leg wallet with inner and front pockets



INFO



SIZES



BELTS WITH CLIPS



INNER POCKET



REFLECTIVE

EA140

+ NEW



Borsello da gamba XL

Leg wallet XL



INFO



SIZES



INNER POCKET



BELTS WITH CLIPS



REFLECTIVE

NEW

EA141



RAIN COVER



ITEMS STORAGE



HARD BAGS

SOFT BAGS

Borsa specifica per moto Honda NC 750X (16-20)
da montare sopra il vano portacasco della moto, 10 litri

*A bag created specifically for the Honda NC750X (16-20)
to be mounted to the cover of the integrated storage
compartment., 10 ltr*

INFO



OPTIONAL



S111 + S110

Kit Power Hub + presa
elettrica 12v

Kit Power Hub + 12v
electrical handlebar
outlet

EA142

★
NEW

SHOULDER STRAP



EXTENSIBLE



RAIN COVER



Borsa da serbatoio con inclusa base specifica per moto enduro. Possibilità di aggancio su vari modelli di moto verificando la compatibilità della base sul vostro serbatoio, oppure utilizzando le cinghie in dotazione.

Tank bag with specific base for Enduro bikes included. Offers the possibility to fix onto various motorcycles by checking the compatibility of the base on your tank, or by using the straps provided.

SPECIFIC BASE



INFO



SIZES



VOLUME



SPECIFIC BASE



EXPANDABLE



RAIN COVER



SHOULDER STRAP



MAP HOLDER



REFLECTIVE



REINFORCED



OPTIONAL



S111 + S110

Kit Power Hub + presa elettrica 12v

Kit Power Hub + 12v electrical handlebar outlet



EA143 TANKLOCK



EXTENSIBLE



SHOULDER STRAP



HARD BAGS

SOFT BAGS

Borsa Tanklock per moto Enduro, 21 litri, estensibile fino a 27 litri. **Da abbinare necessariamente alle flange specifiche BF_ _**

Expandable TANKLOCK Bag for Enduro motorcycles, 21 ltr. Expandable up to 27 ltr. **To match with motorcycle specific mounting ring (BF_ _)**



WATCH THE VIDEO!



INFO



OPTIONAL



S111 + S110

Kit Power Hub + presa elettrica 12v

Kit Power Hub + 12v electrical handlebar outlet

EA144 TANKLOCK



WATCH THE VIDEO!



RAIN COVER



SHOULDER STRAP

 INFO

Borsello da serbatoio TANKLOCK, 5 litri **Da abbinare necessariamente alle flange specifiche BF_ _**

"Mini" TANKLOCK bag, 5 ltr. To match with motorcycle specific mounting ring (BF_ _)



EA145



DETAIL



DRESSED

 INFO

Marsupio con ampio vano centrale

Waist-bag





HARD BAGS

SOFT BAGS

Zaino con chiusura roll top, 20 litri.

Rucksack with Roll Top closure system, 20 ltr.

INFO



XS306 TANKLOCK

TABLET HOLDER



INNER



Borsa da serbatoio Tanklock espandibile, con porta tablet removibile, 25 lt. **Da abbinare necessariamente alle flange specifiche BF_ _**

Tanklock expandable tank bag with removable tablet-holder, 25 lt.

To match with motorcycle specific mounting ring (BF_ _)



INFO



SIZES



VOLUME



TANKLOCK



MAX LOAD



READY TO POWER HUB



RAIN COVER



SHOULDER STRAP



MAP HOLDER



TABLET HOLDER



EXPANDABLE



REFLECTIVE



WATER RESISTANT

XS307 TANKLOCK

TANKLOCK



WATCH THE VIDEO!



Borsa da serbatoio Tanklock espandibile, con porta tablet removibile, 15 lt. **Da abbinare necessariamente alle flange specifiche BF_ _**

Tanklock expandable tank bag with removable tablet-holder, 15 lt.

To match with motorcycle specific mounting ring (BF_ _)



INFO



SIZES



VOLUME



TANKLOCK



MAX LOAD



READY TO POWER HUB



RAIN COVER



SHOULDER STRAP



MAP HOLDER



TABLET HOLDER



EXPANDABLE



REFLECTIVE



WATER RESISTANT

OPTIONAL for XS306 and XS307



S111 + S110

Kit Power Hub + presa elettrica 12v

Kit Power Hub + 12v electrical handlebar outlet

XS308 TANKLOCK



INFO

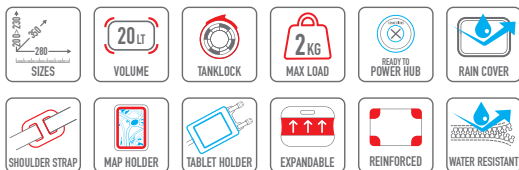

WATCH THE VIDEO!



INFO

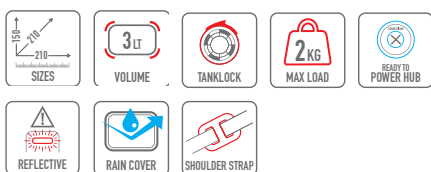

WAIST BAG



Borsa da serbatoio Tanklock per moto Enduro, espandibile, con porta tablet removibile, 20 lt. **Da abbinare necessariamente alle flange specifiche BF__.**

Tanklock Enduro tank bag, expandable with removable tablet-holder, 20 lt. **To match with motorcycle specific mounting ring (BF__)**

XS319 TANKLOCK

SHOULDER STRAP



OPTIONAL for XS308 and XS319



Borsello "Mini" Tanklock, 3 lt. **Da abbinare necessariamente alle flange specifiche BF__**

"Mini" Tanklock bag, 3 lt. **To match with motorcycle specific mounting ring (BF__)**



S111 + S110

Kit Power Hub + presa elettrica 12v

Kit Power Hub + 12v electrical handlebar outlet

XS320 TANKLOCK

TABLET HOLDER



RAIN COVER



WATCH THE VIDEO!



Borsa da serbatoio Tanklock, 15 lt. Specifica per Honda CRF1000L Africa Twin (16>19) / CRF1000L Africa Twin Adventure sports (18 > 19) / CRF1100L Africa Twin (20>21) / CRF1100L Africa Twin Adventure sports (20>21) / Kawasaki Versys 650 (15 > 21). **Da abbinare necessariamente alle flange specifiche BF__.**

Tanklock Enduro tank bag, 5 lt. Specific for Honda CRF1000L Africa Twin (16>19) / CRF1000L Africa Twin Adventure sports (18 > 19) / CRF1100L Africa Twin (20>21) / CRF1100L Africa Twin Adventure sports (20>21) / Kawasaki Versys 650 (15 > 21). **To match with motorcycle specific mounting ring (BF__).**



INFO



SIZES



VOLUME



TANKLOCK



MAX LOAD



READY TO POWER HUB



RAIN COVER



SHOULDER STRAP



MAP HOLDER



TABLET HOLDER



EXPANDABLE



REFLECTIVE



READY TO PADLOCK



OPTIONAL



S111 + S110

Kit Power Hub + presa elettrica 12v

Kit Power Hub + 12v electrical handlebar outlet

XS315 specific for BMW R1200GS (13 > 18) / R 1250 GS (19 > 21)

INFO



Tasche porta attrezzi specifiche per portapacchi BMW R1200GS (13 > 18) / R 1250 GS (19 > 21)
Tool case pockets specifically designed for BMW R1200GS (13 > 18) / R 1250 GS (19 > 21)

HARD BAGS

XS5112E specific for BMW R1200GS Adventure (14 > 18)

INFO



Coppia di borse XSTREAM specifiche da montare sul paramotore originale della BMW R1200GS Adventure (14 > 18)
Pair of XSTREAM panniers to be mounted on the original engine guard of the BMW R1200GS Adventure (14 > 18)

SOFT BAGS

XS5112R specific for BMW R1200GS Adventure (14 > 18)
R1250GS Adventure (19 > 21)

INFO



Borsa porta attrezzi XSTREAM specifica da montare sotto il portapacchi originale della BMW R1200GS Adventure (14 > 18) / R1250GS Adventure (19 > 21)
Specific XSTREAM tool bag, designed to be mounted under the original rear rack of the BMW R1200GS Adventure (14 > 18) / R1250GS Adventure (19 > 21)

CRM102

WATCH THE VIDEO!



MOUNTED IN PAIRS



VEGAN LEATHER



OPTIONAL



CRM107

Cuscino da sella da utilizzare come coprifascia CRM105
Seat pads for covering the CRM105 saddle strap



Borsa laterale singola, 16 lt. Per il fissaggio è necessario l'utilizzo della fascia da sella CRM105 (acquistabile separatamente).

Single side bag, 16 ltr. Use the CRM105 saddle strap to fasten the bag (sold separately)



INFO



CRM105



Fascia da sella per il montaggio della borsa laterale CRM102. Permette il montaggio di una borsa singola oppure di 2 borse laterali. Dimensioni 35x22 cm

CRM106



MOUNTED



PULLER IN HYPALON



HARD BAGS

SOFT BAGS

CRM105



Borsa laterale singola, 13 lt. Per il fissaggio è necessario l'utilizzo della fascia da sella CRM105 (acquistabile separatamente).

Single side bag, 13 ltr. Use the CRM105 saddle strap to fasten the bag (sold separately)

OPTIONAL



CRM107

Cuscino da sella da utilizzare come coprifascia CRM105
Seat pads for covering the CRM105 saddle strap

INFO



WATCH THE VIDEO!



Saddle strap to fix the CRM102 side bag. Can be used to fasten a single or pair of side bags. Size: 35 cm x 22 cm

CRM101

WATCH THE VIDEO!



PHONE HOLDER



DETAILS



Zaino trasformabile in borsa da sella, 18 lt.

Rucksack which can also be used as a saddle bag,
18 ltr.

INFO



SIZES



18L

VOLUME

REMOVABLE
DRY PACK
IPX5

TRANSFORM



BELTS



CRM103



DETAILS



RAIN COVER



PHONE HOLDER



Borsa da serbatoio magnetica, 8 lt.
Magnetic tank bag, 8 ltr.

INFO



WATCH THE VIDEO!



HARD BAGS

SOFT BAGS

CRM104



RAIN COVER



Borsello da gamba dal design classico, 3 lt.

Classically designed leg bag, 3 ltr.



INFO



SIZES



VOLUME



BELTS WITH CLIPS



RAIN COVER



INNER POCKET

CRM107

WATCH THE VIDEO!



MOUNTED



Cuscino da sella da utilizzare come copertura della fascia CRM105. Rende la seduta del passeggero più confortevole. Dimensioni: 25,5 x 21,5 cm. Spessore cuscino 5 cm..

Seat pads for covering the CRM105 saddle strap. It makes the passenger seat more comfortable when side bags are attached. Dimensions: 25.5 x 21.5 cm. Pad width, 5 cm.

MT501 MULTILOCK*

FITTING SYSTEM



HARD BAGS

SOFT BAGS



MT501S MULTILOCK*

Coppia di borse laterali termoformate MULTILOCK*, a carico verticale, 18 lt. **Da abbinare necessariamente ai telaietti specifici (TMT___)**

Pair of thermoformed MULTILOCK* side bags with vertical load, 18 lt. **To be combined with the specific side soft bags holders (TMT___)**

*Patent pending

Borsa laterale SINGOLA termoformata MULTILOCK*, a carico verticale, 18 lt. **Da abbinare necessariamente ai telaietti specifici (TMT___)**

Thermoformed SINGLE side bag MULTILOCK* side bags with vertical load, 18 lt. **To be combined with the specific side soft bags holders (TMT___)**

INFO



WATCH THE VIDEO!



MT505 TANKLOCK



INNER



MOUNTED



WATCH THE VIDEO!



Borsello da serbatoio TANKLOCK, termoformato. Espandibile, 5 lt. **Da abbinare necessariamente alle flange specifiche BF_ _**

TANKLOCK tank bag, thermoformed. Expandable, 5 lt. **To match with motorcycle specific mounting ring (BF_ _)**



INFO



SIZES



VOLUME



TANKLOCKED



READY TO POWER HUB



EXPANDABLE



RAIN COVER



READY TO PADLOCK



SHOULDER STRAP



INNER POCKET

OPTIONAL

S111 + S110

Kit Power Hub + presa elettrica 12v

Kit Power Hub + 12v electrical handlebar outlet

KIT POWER HUB



Kit Power Hub per l'alimentazione interna delle borse da serbatoio. Permette di alimentare tre utenze tramite porta usb ed una quarta con connettore ISO 12v. Da abbinare necessariamente al kit S110. Approved according to directive 2014/30/EU.

S111 Hub kit for the electrical feed for the tank bags. It supplies three devices through the USB ports and a fourth device with the ISO 12v Internal Power connector. To be specifically combined with the S110 kit. Homologated according to directive 2014/30/EU.

Presenza elettrica 12v da montare nella zona del manubrio. Dotata di fusibile e occhielli per il collegamento alla batteria. Permette di creare un circuito indipendente dal controllo della centralina della moto in modo da salvaguardarla da eventuali sovraccarichi. Approved according to directive 2014/30/EU.

S110 12v electrical handlebar outlet. Equipped with fuse and battery connectors. Equipped with fuse and battery connectors. This kit creates an independent circuit from the ignition system of the motorcycle in order to protect it from possible overloads. Homologated according to directive 2014/30/EU.

T521 QUICKPACK



INFO



Quick Pack, zaino richiudibile, 15 lt. Può essere fissato ai sottocoperchi delle valigie in alluminio

Quick Pack, resealable backpack, 15 ltr. It can be fixed to the under lids of aluminum cases

T520 DRY-BAG

MODULABLE



Borsa cargo supplementare Dry bag, 18 lt.

Additional cargo bag Dry bag, 18 ltr.



INFO



SIZES



VOLUME



MODULAR

T515

M.O.L.L.E. SYSTEM



Borsa arrotolabile con scomparto porta attrezzi e gancio per essere agganciata (compatibile con il sistema M.O.L.L.E.). Dimensioni idonee per l'inserimento nella S250 TOOLBOX

Roll-top bag with tool compartment and hook (compatible with M.O.L.L.E.). Suitable to be placed inside the S250 TOOLBOX



INFO



ELASTIC STRAP



REFLECTIVE



UV TESTED



MODULAR



INNER POCKET

T516



Borsello universale da manubrio
con scomparto porta cellulare.

*Universal handlebar pouch with
internal mobile phone compartment.*

INFO



T517



Borsello da gamba con tasca interna
e anteriore

*Leg wallet with inner and front
pockets*

INFO



Gli allestimenti e le soluzioni proposte e rappresentate nel presente catalogo potrebbero non essere conformi alle leggi di alcuni paesi. Si invita pertanto l'acquirente dei prodotti GIVI a verificare che quanto sta acquistando non sia in contrasto con le normative vigenti nel proprio stato o di quelli che intende visitare con la propria motocicletta. Qualsiasi fotografia, rappresentazione grafica o allestimento consigliato non sottintende perciò garanzia di conformità da parte di GIVI con le normative di ogni paese. Tutti i marchi e i modelli dei dispositivi citati sono di proprietà dei rispettivi titolari. NB: Le soluzioni fotografate nel seguente catalogo sono esemplificative della gamma GIVI e a scopo esclusivamente illustrativo. GIVI si riserva il diritto di modificare interamente o in parte, aggiungere o eliminare i prodotti senza preavviso.

The fitting solutions proposed and displayed in this catalogue may not comply with all the Laws in force in some Countries. Therefore it is the responsibility of the purchaser of GIVI products to verify that the products they are purchasing do not conflict with the rules in force in their Country of residence or in any Countries they intend to visit on their motorcycle. In the light of this, each picture, graphic representation or suggested solution is not intended as a guarantee of the conformity of GIVI products with the rules in force in each Country. All trademarks, names and pda models cited are property of the respective Companies.

NB: The pictures shown in the catalogue are only examples from the GIVI range and are for illustration purpose only. GIVI reserves the right to modify whole or in part, add or delete the products shown without notice.



HEADQUARTERS:
GIVI S.P.A. _ Flero (BS) Italy
Fax +39 030 35 80 518
info@givi.it _ www.givi.it

BRASIL:
GIVI DO BRASIL LTDA
Ph. +55 12 3644 8025 _ Fax +55 12 3644 8029
info@givi.com.br _ www.givi.com.br

FRANCE:
GIVI FRANCE
Ph. (04) 72 25 79 41 _ Fax (04) 72 25 03 73
givi.france@givi.fr _ www.givi.fr

GERMANY:
GIVI DEUTSCHLAND GmbH
Ph. (0) 911 955100 _ Fax (0) 911 9551022
office@givi-deutschland.de _ www.givi.de

MALAYSIA:
GIVI ASIA SDN BHD
Ph. (603) 6028 3800 _ Fax (603) 6028 1300
enquiry@givi.com.my _ www.givi.com.my

SPAIN:
GIVI CONCESSIONAIRES IBERICA S.L.U.
Ph. (93) 8906820 _ Fax (93) 8906802
givi@givi.es _ www.givi.es

UK:
GIVI UK LTD
Ph. (01327) 706220 _ Fax (01327) 706239
info@givi.co.uk _ www.givi.co.uk

USA:
GIVI USA INC
East Coast _ Ph. (704) 679 4123
West Coast _ Ph. (775) 359 0900
info@giviusa.com _ www.giviusa.com

VIETNAM:
GIVI VIETNAM CO. LTD.
Ph. +84 72 3769137 _ Fax +84 72 3769120
info@givi.com.vn _ www.givi.com.vn

INDONESIA:
PT GIVI INDONESIA
Ph. +6221 7588 2582 _ Fax +6221 7588 2431
info@givi.co.id _ www.givi.co.id

CHINA:
DONGGUAN GIVI TRADING CO. LTD.
Ph. + 86 769 22992660 _ Fax+86 769 22992680
service@givcn.com _ www.givcn.com

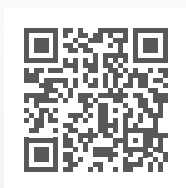

Find more than 1000 accessories at givimoto.com
Discover giviexplorer.com the web portal for motorcyclist



* X 1 5 5 - 2 2 *